

Dependence of non-thermal biological effects of microwaves on physical and biological variables: implications for reproducibility and safety standards

Igor Y Belyaev

Laboratory of Molecular Genetics, Cancer Research Institute, Bratislava, Slovak Republic

Laboratory of Radiobiology, General Physics Institute, Russian Academy of Science, Moscow, Russia

Department of Genetic and Cellular Toxicology, Stockholm University, Stockholm, Sweden

Abstract

Diverse biological responses, including adverse health effects, to non-thermal (NT) microwaves (MW) have been described by many research groups all over the world. The aim of this paper is to provide an overview of the complex dependence of these effects on various physical and biological parameters, which must be controlled in replication studies.

Besides well-known dependencies on carrier frequency and modulation, emerging data suggest dependencies of NT MW effects on polarization, intermittence and coherence time of exposure, static magnetic field, electromagnetic stray fields, genotype, gender, physiological and individual traits, cell density during exposure. Data also indicate that duration of exposure may be as important as power density (PD) and specific absorption rate (SAR). Further evaluation of these dependencies are needed for understanding the mechanisms by which NT MW affect biological systems, planning *in vivo* and epidemiological studies, developing medical treatments, setting safety standards, and minimizing the adverse effects of MW from mobile communication.

***Key words:* non-thermal effects of microwaves, mobile (cellular) phones, safety standards.**

List of abbreviations:

Anomalous viscosity time dependence (AVTD); blood-brain barrier (BBB); catalase (CAT); Digital Enhanced (former European) Cordless Telecommunications (DECT); circularly polarized (CP); continuous wave (CW); Digital Advanced Mobile Phone System (DAMPS); discontinuous transmission (DTX); electroencephalographic (EEG); electromagnetic field (EMF); embryonic stem (ES) cells; ethidium bromide (EtBr); extremely low frequency (ELF); Gaussian Minimum Shift Keying (GMSK); Ginkgo biloba (Gb); Global System for Mobile Communication (GSM); glutathione peroxidase (GSH-Px); International Commission for Non-Ionizing Radiation Protection (ICNIRP); linearly polarized (LP); malondialdehyde (MDA); micronucleus (MN) assay; microwaves (MWs); N-acetyl-beta-d-glucosaminidase (NAG); nitric oxide (NO); non-thermal (NT); ornithine decarboxylase (ODC); phorbol ester 12-myristate 13-acetate (PMA); phosphorylated H2AX histone (γ -H2AX); power density (PD);

Address: Igor Y Belyaev, Ph D, D Sc. Cancer Research Institute, Slovak Academy of Sciences, Vlárská 7, 833 91 Bratislava, Slovak Republic - Tel: +421 259327322 - Fax: +421 259327305
E-mail: Igor.Belyaev@gmt.su.se

regional cerebral blood flow (rCBF); Russian National Committee on Non-Ionizing Radiation Protection (RNCNIRP); specific absorption rate (SAR); static magnetic field (SMF); superoxide dismutase (SOD); Time Division Multiple Access (TDMA); tumor suppressor p53 binding protein 1 (53BP1); ultraviolet (UV); Universal Mobile Telecommunications System (UMTS).

Introduction

Exposures to non-ionizing electromagnetic fields vary in many parameters: power (specific absorption rate, incident power density), wavelength/frequency, near field/far field, polarization (linear, circular), continuous wave (CW) and pulsed fields (that include variables such as pulse repetition rate, pulse width or duty cycle, pulse shape, pulse to average power, etc.), modulation (amplitude, frequency, phase, complex), static magnetic field (SMF) and electromagnetic stray fields at the place of exposure, overall duration and intermittence of exposure (continuous, interrupted), acute and chronic exposures. With increased absorption of energy, so-called thermal effects of microwaves (MW) are usually observed that deal with MW-induced heating. Specific absorption rate (SAR) or power density (PD) is a main determinate for thermal MW effects. Several other physical parameters of exposure have been reported to be of importance for so-called non-thermal (NT) biological effects, which are induced by MW at intensities well below any measurable heating¹⁻¹¹. An important question is how these physical parameters could be taken into account in setting safety standards.

Most often, current safety standards are based on thermal MW effects observed in short-term (acute) exposures. On the other hand, NT MW effects, especially those induced during prolonged (chronic) exposures, are accepted and taken into account for setting the national safety standards in some countries such as Russia¹⁰⁻¹². It should be noted that, in contrast to the ICNIRP (International Commission for Non-Ionizing Radiation Protection) safety standards¹³ which are based on the acute thermal effects of MW, the standards adopted by the Russian National Committee on Non-Ionizing Radiation Protection (RNCNIRP) are based on experimental data from chronic (up to 4 month) exposures of animals to MW at various physical parameters including intensity, frequency and modulation, obtained from research performed in the former Soviet Union¹⁰⁻¹².

Since setting the current safety standards, the situation with exposure of the general population to MW has changed significantly. Nowadays, most of the human population is chronically exposed to MW signals from various sources including mobile phones and base stations. These exposures are characterized by low intensities, varieties and complexities of signals, and long-term durations of exposure that are comparable with a lifespan. So far, the “dose” (accumulated absorbed energy that is measured in radiobiology as the dose rate multiplied by exposure time) is not adopted for the MW exposures and SAR or PD is usually used for guidelines. To what degree SAR/PD can be applied to the nowadays NT MW chronic exposures is not known and the current state of research demands reevaluation of the safety standards¹².

There are two main approaches to treat numerous data regarding NT MW effects. The first one is based on the consideration of these effects in dependence on various physical parameters and biological variables as has consistently been described in many experimental studies and will be reviewed in this paper. The second approach is based on neglecting or minimizing the experimentally observed NT MW effects based on the current state of theoretical physical science that is insufficient for comprehensive expla-

nation of the NT MW effects. As a result of such various treatments of the experimental data, the safety standards significantly vary, up to 1000 times, among countries.

The literature on the NT MW effects is very broad. There are four lines of evidence for the NT MW effects: (1) altered cellular responses in laboratory *in vitro* studies and results of chronic exposures *in vivo* studies^{3, 11, 14}; (2) results of medical application of NT MW in the former Soviet Union countries^{4, 7, 15, 16}; (3) hypersensitivity to electromagnetic fields (EMF); (4) epidemiological studies suggesting increased cancer risks for mobile phone users¹⁷⁻¹⁹.

This paper is not intended to be a comprehensive review of this literature. In this review, we will focus on the studies which evaluate dependence of the NT MW effects on physical parameters and biological variables.

Experimental studies

The first data on the NT effects of MW in so-called millimeter range (wavelength 1-10 mm in vacuum) was obtained by Vilenskaya and co-authors²⁰ and Devyatkov²¹. Highly resonant effects of ultra-weak MW (near 70 GHz) on the induction of λ -phage were first established by Webb²², and subsequently corroborated²³. In these and subsequent studies the observed spectra of MW action were found to have the following common properties: (1) the MW effects were strongly dependent on the frequency (frequency windows), (2) there was an associated power (intensity) threshold below which no effect was observed, and above which the effects of exposure depended only weakly on power over several orders of magnitude (so-called S-shaped or sigmoid dependence), (3) the occurrence of MW effects depended on the duration of exposure, a certain minimum duration of exposure was necessary for an effect to manifest itself. These important regularities of the NT MW effects have previously been reviewed^{2, 7-9, 24-27}.

The first investigations of the NT MW effects at lower frequency ranges were performed by Blackman and colleagues²⁸⁻³⁰ and Adey and colleagues^{31, 32}. These groups found dependence of the NT MW effects on modulation.

Since that time, other groups have confirmed and extended the main findings of these pioneering studies as will be reviewed below.

Frequency dependence and frequency windows

The effects of NT MW on DNA repair in *E. coli* K12 AB1157 were studied by the method of anomalous viscosity time dependence (AVTD)^{33, 34}. The AVTD method is a sensitive technique to detect changes in conformation of nucleoids/chromatin induced by either genotoxic or stress factors³⁵⁻⁴⁰. Significant inhibition of DNA repair was found when X-ray-irradiated cells were exposed to MW within the frequency ranges of 51.62-51.84 GHz and 41.25-41.50 GHz. The effects were observed within two "frequency windows", both displaying a pronounced resonance character with the resonance frequencies of 51.755 GHz and 41.32 GHz, respectively^{33, 34}. Of note, these MW effects were observed at PD well below any thermal effects and could not be accounted for by heating. The frequency windows of resonance type have often been termed "resonances" as also will be used below.

The resonance frequency of 51.755 GHz was stable within the error of measurements, ± 1 MHz with decreasing the PD from $3 \cdot 10^{-3}$ to 10^{-19} W/cm²^{34, 35}. At the same time, the

half-width of the resonance decreased from 100 MHz to 3 MHz revealing an extremely sharp dependence on frequency ($Q \sim 10^4$). This sharp narrowing of the 51.755 GHz resonance with decreasing the PD from $3 \cdot 10^{-3}$ to 10^{-7} W/cm² followed by an emergence of new resonances, 51.675 ± 0.001 , 51.805 ± 0.002 , and 51.835 ± 0.005 GHz^{35, 41}. The half-widths of all these resonances including the main one, 51.755 ± 0.001 GHz, were about 10 MHz at the PD of 10^{-10} W/cm². These data were interpreted in the framework of the model of electron-conformational interactions as a splitting of the main resonance 51.755 GHz by the MW field³⁵.

The MW effects were studied at different PD and several frequencies around the resonance frequency of 51.675 GHz⁴¹. This resonance frequency was found to be stable, ± 1 MHz, within the PD range of 10^{-18} - 10^{-8} W/cm². Along with disappearance of the 51.675 GHz resonance response at the sub-thermal PD of 10^{-6} - 10^{-3} W/cm², a new resonance effect arose at 51.688 ± 0.002 GHz⁴¹. This resonance frequency was also stable within the PD range studied.

Taken together, these data^{34, 35, 41} suggested a sharp rearrangement of the frequency spectra of MW action, which was induced by the sub-thermal MW. The half-widths of all three resonances depended on PD, changing either from 2-3 MHz to 16-17 MHz (51.675 GHz and 51.668 GHz resonances) or from 2-3 MHz to 100 MHz (51.755 GHz resonance)^{35, 41}. The data indicated also that dependencies of half-width on PD might vary for different resonance frequencies.

Significant narrowing in resonance response with decreasing PD has been found when studying the growth rate in yeast cells⁴² and chromatin conformation in thymocytes of rats⁴³. In the Gründler's study, the half-width of the resonance (near 41 GHz) decreased from 16 MHz to 4 MHz as PD decreased from 10^{-2} W/cm² to 5 pW/cm²⁴².

Thus, the results of studies with different cell types indicate that narrowing of the resonance window upon decrease in PD is one of the general regularities in cell response to NT MW. This regularity suggests that many coupled oscillators are involved non-linearly in the response of living cells to NT MW as has previously been predicted by Fröhlich⁴⁴.

Gapeev *et al.* studied effects of MW exposure (frequency range 41.75-42.1 GHz, frequency increment 50 MHz, PD 240 μ W/cm²) on the respiratory burst induced by calcium ionophore A23187 and phorbol ester 12-myristate 13-acetate (PMA) in the peritoneal neutrophils of mice^{45, 46}. MW inhibited the respiratory burst. MW effect displayed resonance-like dependence on frequency, the resonance frequency and half-width of the resonance being 41.95 GHz and 160 MHz, respectively ($Q = 260$)^{45, 46}. In other studies, Gapeev *et al.* analyzed acute zymosan-induced paw edema in mice^{47, 48}. MW exposure of animals at the PD of 0.1 mW/cm² resulted in decrease of the paw edema that was frequency-dependent in the range of 42-43 GHz.

Based on the extrapolation from the data obtained in the extremely high frequency range (30-300 GHz), the values for half-width of resonances at the frequency range of mobile phones (0.9-2 GHz) were estimated to be 1-10 MHz⁴⁰. Effects of GSM (Global System for Mobile Communication) MW on chromatin conformation and 53BP1 (tumor suppressor p53 binding protein 1)/ γ -H2AX (phosphorylated H2AX histone) DNA repair foci in human lymphocytes were studied in this frequency range^{38-40, 49}. Dependence of these MW effects on carrier frequency was observed^{38, 40, 49}. This dependence was replicated in independent experiments with lymphocytes from twenty six healthy and hypersensitive persons^{38, 39, 49}.

Tkalec and colleagues exposed duckweed (*Lemna minor L.*) to MW at the frequencies of 400, 900, and 1900 MHz⁵⁰. The growth of plants exposed for 2 h to a 23 V/m

electric field of 900 MHz significantly decreased in comparison with the control, while an electric field of the same strength but at 400 MHz did not have such effect. A modulated field at 900 MHz strongly inhibited the growth, while at 400 MHz modulation did not influence the growth significantly. At both frequencies, a longer exposure mostly decreased the growth and the highest electric field (390 V/m) strongly inhibited the growth. Exposure of plants to lower field strength (10 V/m) for 14 h caused a significant decrease at 400 and 1900 MHz while 900 MHz did not influence the growth. Peroxidase activity in exposed plants varied, depending on the exposure characteristics. Observed changes were mostly small, except in plants exposed for 2 h to 41 V/m at 900 MHz where a significant increase (41%) was found. The authors concluded that MW might influence plant growth and, to some extent, peroxidase activity. However, the effects of MW strongly depended on the characteristics of the field exposure such as frequency and modulation. These dependences were confirmed in further study of the same group^{51, 52}.

Remondini *et al.* analyzed changes in gene expression in human EA.hy926 endothelial cells using gene microarrays⁵³. Cells were exposed to MW (SAR 1.8-2.5 W/kg, 1 h exposure) either at 900-MHz GSM Basic mode or 1800-MHz GSM Basic mode. Exposure to 900 MHz resulted in up-regulation in 22 genes and down-regulation in 10 genes. No significant change in gene expression was observed after exposure to 1800 MHz.

Sigmoid intensity dependences and power windows

It was found by Devyatkov *et al.* that NT MW effects display sigmoid dependence on intensity above certain intensity thresholds²¹. This type of PD dependence for the MW effects was observed in other studies as previously reviewed^{7-9, 24, 25}.

The data obtained in experiments with *E. coli* cells and rat thymocytes provided new evidence for sigmoid type of PD dependence and suggested that similar to ELF effects, MW effects may be observed within specific “intensity windows”^{35, 41, 43, 54}. The most striking example of the sigmoid PD dependence was found at the resonance frequency of 51.755 GHz³⁵. When exposing *E. coli* cells at the cell density of $4 \cdot 10^8$ cell/ml, the effect reached saturation at the PD of 10^{-18} - 10^{-17} W/cm² and did not change up to PD of 10^{-3} W/cm². In these experiments, the direct measurements of PD below 10^{-7} W/cm² were not available and lower PD was obtained using calibrated attenuators. Therefore, some uncertainty in the evaluation of the lowest PD was possible. The background MW radiation in this frequency range has been estimated to be 10^{-21} - 10^{-19} W/m²/Hz⁵⁵. Based on the experimentally determined half-width of the 51.755 GHz resonance, 1 MHz³⁵, the background PD was estimated as 10^{-19} - 10^{-17} W/cm² within the 51.755 GHz resonance. The resonance MW effects on *E. coli* cells were observed at the PD very close to the estimated background value^{35, 41, 56-58}. These data suggested that the PD dependence of MW effect at the specific resonance frequencies might have a threshold comparable with the background level. Dependence of the MW effect on PD at one of the resonance frequencies, 51.675 GHz, had the shape of “intensity window” in the PD range from 10^{-18} to 10^{-8} W/cm²⁴¹. It is interesting, that no MW effect at this resonance frequency was observed at sub-thermal and thermal PD. This type of PD dependence has supported hypothesis about possible rearrangement of the frequency MW spectra action by the MW field³⁵. The position of the PD window varied between different resonance frequen-

cies and depended on cell density during exposure of cells⁴¹. Despite some uncertainty in the evaluation of PD at the levels below 10^{-7} W/cm² in the referred studies the data indicated that NT MW at the resonance frequencies may result in biological effects at very low intensities comparable with intensities from base stations and other MW sources used in mobile communication.

Gapeev *et al.* have studied dependence of the MW effects at the resonance frequency of 41.95 GHz on the respiratory burst induced by calcium ionophore A23187 and PMA in the peritoneal neutrophils of mice^{45, 46}. Inhibitory effects of MW exposure has been observed at the PD of 0.001 mW/cm² and displayed sigmoid dependence on PD at higher power densities^{45, 46}.

In other study, Gapeev *et al.* analyzed acute zymosan-induced paw edema in mice⁴⁸. MW exposure of animals at the frequency of 42.2GHz and exposure duration of 20 min decreased the paw edema. Sigmoid dependence of this effect on PD has been obtained with a maximum reached at the PD of 0.1 mW/cm².

In their pioneering study on blood-brain barrier (BBB) permeability, Oscar and Hawkins exposed rats to MW at 1.3 GHz and analyzed BBB permeability by measuring uptake of several neutral polar substances in certain areas of the brain⁵⁹. A single, 20 min exposure, to continuous wave (CW) MW increased the uptake of D-mannitol at average power densities of less than 3 mW/cm². Increased permeability was observed both immediately and 4 h after exposure, but not 24 h after exposure. After an initial rise at 0.01 mW/cm², the permeability of cerebral vessels to saccharides decreased with increasing microwave power at 1 mW/cm². Thus, the effects of MW were observed within the power window of 0.01-0.4 mW/cm². Differences in the level of uptake occurred between effects of CW MW and pulsed MW of the same average power. Microwaves of the same average power but different pulse characteristics also produced different uptake levels.

These findings on “power windows” for BBB permeability have been subsequently corroborated by the group of Persson and Salford^{60, 61}. In their recent study, the effects of GSM MW on the permeability of the BBB and signs of neuronal damage in rats were investigated using a real GSM programmable mobile phone in the 900 MHz band⁶². The rats were exposed for 2 h at an SAR of 0.12, 1.2, 12, or 120 mW/kg. Albumin extravasation and also its uptake into neurons increased after 14 d. The occurrence of dark neurons in the rat brains increased later, after 28 d. Both effects were seen already at 0.12 mW/kg with only slight increase, if any, at higher SAR values.

Duration of exposure and time after exposure

Bozhanova with co-authors reported that the effect of cellular synchronization induced by NT MW depended on duration of exposure and PD⁶³. The dependence on duration of exposure fitted to exponential function. The important observation was that in order to achieve the same synchronization of cells, the decrease in PD could be compensated by the increase in the duration of exposure.

Kwee and Raskmark analyzed effects of MW at 960 MHz and various SARs, 0.021, 0.21, and 2.1 mW/kg on proliferation of human epithelial amnion cells⁶⁴. These authors reported linear correlations between exposure time to MW at 0.021 and 2.1 mW/kg and the MW-induced changes in cell proliferation albeit no such clear correlation was seen at 0.21 mW/kg.

MW exposure of *E. coli* cells and rat thymocytes at PDs of 10^{-5} - 10^{-3} W/cm² resulted in significant changes in chromatin conformation if exposure was performed at resonance frequencies during 5-10 min^{33, 43, 65}. Decrease in the MW effects due to lowering the PD by orders of magnitude down to 10^{-14} - 10^{-17} W/cm² was compensated by several-fold increase of exposure time to 20-40 min⁵⁷. At the relatively longer duration of exposure, more than 1 h, the same effect at the lowest PD of 10^{-19} W/cm² was observed⁵⁷.

Gapeyev *et al.* found the frequency and power dependence of anti-inflammatory effect of low-intensity MW exposure (0.1 mW/cm²) using the model of acute zymosan-induced footpad edema in mice⁴⁷. Single whole-body MW exposure of mice at the frequencies of 42.2, 51.8, and 65 GHz after zymosan injection reduced both the footpad edema and local hyperthermia. Some other frequencies from the frequency range of 37.5-70 GHz were less effective or not effective at all. At the frequency of 42.2 GHz the effect had sigmoid dependence on exposure duration with a maximum at 20-80 min. A linear dependence with significantly lower increment was observed at a 10-fold less intensity (0.01 mW/cm²). However, this decrease in the effect was compensated by a slight increase in duration of exposure from 80 min to 120 min.

The MW effects on *E. coli* cells depended on the post-exposure time⁵⁶⁻⁵⁸. This dependence had an initial phase of increase about 100 min post-exposure followed by a phase, which was close to a plateau, around 100 min. A trend to decrease in effect was observed at longer times up to 300 min^{56, 58}.

Significant MW-induced changes in chromatin conformation were observed when rat thymocytes were analyzed in-between 30-60 min after exposure to MW⁴³. This effect nearly disappeared if the cells were incubated more than 80 min between exposure and analysis.

Gapeyev *et al.* have studied dependence of the MW effect on the function of the mouse peritoneal neutrophils in dependence on duration of exposure at the frequency of 41.95 GHz and the PD of 240 μ W/cm²^{45, 46}. This dependence had a bell-shaped form with the maximal effects at 20 - 40 min of exposure.

In recent studies, human lymphocytes from peripheral blood of healthy and hypersensitive to EMF persons were exposed to MW from the GSM mobile phones^{38, 39}. MW induced changes in chromatin conformation similar to those induced by heat shock, which remained up to 24 h after exposure. It was found in the same and following studies that GSM MW at the carrier frequency of 915 MHz and UMTS (Universal Mobile Telecommunications System) MW at 1947.4 MHz inhibited formation of 53BP1/ γ -H2AX DNA repair foci and these adverse effects remained at 72 h after an 1-h exposure^{38, 39, 49}.

Of note is that prolonged MW exposures were associated with less prominent effects than shorter exposures in some studies^{51, 66, 67}. This type of dependence on exposure duration was explained by adaptation of the exposed systems to the MW exposure⁶⁷.

The data indicate that there is a time window for observation of the NT MW effects, which may be dependent on endpoint measured, cell type, duration and PD of exposure. The data from different groups suggest also that duration of exposure may have a larger role for some NT MW effects than PD/SAR.

Coherence time

MW exposure of L929 fibroblasts was performed by the group of Litovitz⁶⁸. MW at 915 MHz modulated at 55, 60, or 65 Hz approximately doubled ornithine decarboxylase

(ODC) activity after 8 h. Switching the modulation frequency from 55 to 65 Hz at coherence times of 1.0 s or less abolished enhancement, while times of 10 s or longer provided full enhancement. These results suggested that the microwave coherence effects are remarkably similar to those observed previously with extremely low frequency (ELF) magnetic fields by the same authors.

Intermittence

Diem and colleagues exposed cultured human diploid fibroblasts and cultured rat granulosa cells to intermittent and continuous MW (1800 MHz; SAR 1.2 or 2 W/kg; different modulations; during 4, 16 and 24 h; intermittent 5 min on/10 min off or continuous exposure)⁶⁹. Comet assay was applied to analyze DNA single- and double-strand breaks. MW-induced effects occurred after 16 h exposure in both cell types and after different mobile-phone modulations. The intermittent exposure showed a stronger effect than continuous exposure.

Remondini *et al.* analyzed changes in gene expression in human HL-60 leukemia cells using gene microarrays⁵³. Cells were exposed to MW (SAR 1.0-1.3 W/kg, 1800 MHz DTX mode, 24 h exposure) either continuously or intermittently, 5 min ON/5 min OFF. Gene expression was affected by intermittent exposure but not continuous exposure.

Modulation

There is strong experimental evidence for the role of modulation in the diverse biological effects of NT MW both *in vitro* and *in vivo*^{32, 60, 70-79}. Examples include different types of modulation such as amplitude-, speech and phase modulations: (i) Amplitude modulation at 16 Hz, but not 60 Hz or 100 Hz, of a 450-MHz MW increased activity of ODC⁷⁴. (ii) Speech-modulated 835-MHz MW produced no effect on ODC as compared to the typical signal from a TDMA (Time Division Multiple Access) digital cellular phone⁷¹. (iii) Phase-modulated GSM-1800 MW (Gaussian Minimum Shift Keying, GMSK) at 1.748 GHz induced micronuclei in human lymphocytes while CW MW did not⁷⁵.

Gapeev and co-authors studied production of reactive oxygen species (ROS) in isolated peritoneal neutrophils of mice using a model of synergistic reaction of calcium ionophore A23187 and phorbol ester PMA^{79, 80}. MW exposure at 41.95 GHz, continuous wave mode and 50 $\mu\text{W}/\text{cm}^2$, inhibited ROS production. MW modulated with the frequency of 1 Hz resulted in stimulation of the synergistic reaction. Modulation frequencies of 0.5, 2, 4, and 8 Hz did not cause significant effects, and modulation frequencies of 0.1, 16, and 50 Hz inhibited the synergistic reaction.

In other study, Gapeev *et al.* analyzed acute zymosan-induced paw edema in mice⁴⁸. MW exposure of animals at the PD of 0.1- 0.7 mW/cm² and some “effective” frequencies in the range of 42-43 GHz decreased the paw edema. Application of different modulation frequencies from the range of 0.03–100 Hz to MW exposure at the effective carrier frequency of 42.2 GHz did not lead to considerable changes in the effect. In contrast, modulation of MW at the “ineffective” carrier frequencies of 43.0 and 61.22 GHz by frequencies from the ranges of 0.07–0.1 and 20–30 Hz resulted in a maximal anti-inflammatory effects. The results suggested a complex dependence of

the anti-inflammatory action of low-intensity MW on carrier and modulation frequencies.

Huber with co-authors investigated effects of MW similar to those used in mobile communication, a “base-station-like” and a “handset-like” signal (10 g tissue-averaged spatial peak-SAR of 1 W/kg for both conditions), on waking regional cerebral blood flow (rCBF) in 12 healthy young men⁷⁶. The effect depended on the spectral power in the amplitude modulation of the carrier frequency such that only “handset-like” MW exposure with its stronger low-frequency components but not the “base-station-like” MW exposure affected rCBF. This finding supported previous observations of these authors⁷⁷ that pulse modulation of MW is of importance for changes in the waking and sleep EEG, and substantiated the notion that pulse modulation is crucial for MW-induced alterations in brain physiology.

Markkanen *et al.* exposed cdc48-mutated *Saccharomyces cerevisiae* yeast cells to 900 or 872 MHz MW, with or without exposure to ultraviolet (UV) radiation, and analyzed apoptosis⁷⁸. Amplitude modulated (217 pulses per second) MW significantly enhanced UV induced apoptosis in cells, but no effect was observed in cells exposed to unmodulated fields at the identical time-average SAR of 0.4 W/kg that was lower than the ICNIRP safety standards.

Persson and colleagues studied effects of MW of 915 MHz as CW and pulse-modulated with different pulse power and at various time intervals on permeability of the blood-brain barrier (BBB) in Fischer 344 rats⁶⁰. Albumin and fibrinogen were demonstrated immunochemically and classified as normal versus pathological leakage. The CW-pulse power varied from 0.001 W to 10 W and the exposure time from 2 min to 960 min. The frequency of pathological rats significantly increased in all exposed rats. Grouping the exposed animals according to the level or specific absorption energy (J/kg) gave significant difference in all levels above 1.5 J/kg. The exposure was 915 MHz MW either pulse modulated at 217 Hz with 0.57 ms pulse width, at 50 Hz with 6.6 ms pulse width, or CW. The frequency of pathological rats was significantly higher in MW-exposed groups than in controls and the frequency of pathological rats after exposure to pulsed radiation was significantly less than after exposure to CW.

In a study by Lopez-Martin *et al.*⁸¹, GSM-exposed picrotoxin-pretreated rats showed differences in clinical and EEG signs, and in c-Fos expression in the brain, in comparison to picrotoxin-treated rats exposed to an equivalent dose of unmodulated radiation. Neither MW exposure caused tissue heating, so thermal effects could be ruled out. The most marked effects of GSM MW on c-Fos expression in picrotoxin-treated rats were observed in limbic structures, olfactory cortex areas and subcortical areas, the dentate gyrus, and the central lateral nucleus of the thalamic intralaminar nucleus group. Nonpicrotoxin-treated animals exposed to unmodulated radiation showed the highest levels of neuronal c-Fos expression in cortical areas. These results suggested a specific effect of the pulse GSM modulation on brain activity of a picrotoxin-induced seizure-proneness rat model.

Luukkonen *et al.*⁸² investigated effects of MW at 872 MHz and relatively high SAR value (5 W/kg) on intracellular reactive oxygen species (ROS) production and DNA damage in human SH-SY5Y neuroblastoma cells. The experiments also involved combined exposure to MW and menadione, a chemical inducing intracellular ROS production and DNA damage. Both CW and a pulsed signal similar to that used in GSM mobile phones were used. Exposure to the CW radiation increased DNA breakage in comparison to the cells exposed only to menadione. Comparison of the same groups also

showed that ROS level was higher in cells exposed to CW RF radiation at 30 and 60 min after the end of exposure. No effects of the GSM-like modulated signal were seen on either ROS production or DNA damage.

Hinrikus *et al.*⁸³ evaluated the effects of MW (450 MHz) pulse-modulated at the frequencies of 7, 14 and 21 Hz on human electroencephalographic (EEG) rhythms. The field power density at the scalp was 0.16 m W/cm². Modulated microwaves caused an increase in the average EEG alpha (17%) and beta (7%) power but the theta rhythm remained unaffected. Increases in the EEG alpha and beta power were statistically significant during the first half-period of the exposure interval (30 s) at the modulation frequencies of 14 and 21 Hz. The authors concluded that the effect of the 450-MHz MW modulated at 7, 14 and 21 Hz varies depending on the modulation frequency.

Hoyto *et al.*⁸⁴ exposed human SH-SY5Y neuroblastoma and mouse L929 fibroblast cells to MW (SAR of 5 W/kg) at 872 MHz using continuous-waves (CW) or a modulated GSM-like signal under isothermal conditions⁸³. Menadione was used to induce reactive oxygen species, and tert-butylhydroperoxide (t-BOOH) was used to induce lipid peroxidation. Two statistically significant differences related to MW exposure were observed: Lipid peroxidation induced by t-BOOH was increased in SH-SY5Y (but not in L929) cells, and menadione-induced caspase 3 activity was increased in L929 (but not in SH-SY5Y) cells. Both differences were statistically significant only for the GSM-modulated signal.

Franzellitti *et al.*⁸⁵ exposed human trophoblast HTR-8/SVneo cells to MW at 1.8 GHz CW and differently modulated GSM signals (GSM-217Hz and GSM-Talk) during 4 - 24 h⁸⁴. The inducible HSP70C transcript was significantly enhanced after 24 h exposure to GSM-217 Hz signals while being reduced after 4 and 16 h exposure to GSM-Talk signal.

Significant amount of *in vivo* studies under varying parameters of exposure (intensity, frequency, exposure time, modulation, intermittence) have been performed in Russia/Soviet Union and published in Russian. Retrospective analysis of 52 Russian/Soviet *in vivo* studies with animals (mice, rats, rabbits, guinea pigs) on chronic exposure to MW has recently been published¹¹. In these studies, various endpoints were measured up to 4 month of chronic exposure including analysis of: weight of animal body, histological analysis and weight of tissues, central nervous system, arterial pressure, blood and hormonal status, immune system, metabolism and enzymatic activity, reproductive system, teratogenic and genetic effects. Based on their analysis, the authors concluded that: "exposure to modulated MW resulted in bioeffects, which can be different from the bioeffects induced by CW MW; exposure to modulated MW at low intensities (non-thermal levels) could result in development of unfavorable effects; direction and amplitude of the biological response to non-thermal MW, both *in vitro* and *in vivo*, depended on type of modulation; often, but not always, modulated MW resulted in more pronounced bioeffects than CW MW; the role of modulation was more pronounced at lower intensity levels".

One review of the Russian/Soviet studies on the role of modulation on MW effects is available in English¹⁵. The authors conclude that "a number of good-quality studies have convincingly demonstrated significant bioeffects of pulsed MW. Modulation often was the factor that determined the biological response to irradiation, and reactions to pulsed and CW emissions at equal time-averaged intensities in many cases were substantially different".

In conclusion, significant amount of in vitro and in vivo studies from different research groups, although not universally reported, clearly indicated dependence of the MW effects on modulation.

Polarization

It is believed that circular polarization might have been important in inducing chiral asymmetry in interstellar organic molecules that could be subsequently delivered to the early Earth and could explain the origin of the chirality of biological molecules⁸⁶.

The effects of circularly polarized (CP) MW were studied in *E. coli* cells at the frequencies from two frequency windows (resonances) that were identified using linearly polarized (LP) MW, within the frequency ranges of 51.62-51.84 GHz and 41.25-41.50 GHz^{34, 65}. At the resonance frequency of 51.76 GHz, right-handed CP MW inhibited repair of X-ray-induced DNA damages^{34, 65}. In contrast to right-handed polarization, left-handed CP MW had virtually no effect on the DNA repair, while the efficiency of LP MW was in-between of two circular polarizations. Inversion in effectiveness of circular polarizations was observed at another resonance frequency, 41.32 GHz. In contrast to the frequency of 51.76 GHz, left-handed CP MW at 41.32 GHz significantly inhibited DNA repair, while right polarization was almost ineffective. MW of the same CP affected cells at several frequencies tested within each resonance, alternative CP being almost ineffective^{34, 54, 65}. Therefore, specific sign of effective CP, either left- or right-, was the attribute of each resonance. Two different types of installations, based on either spiral waveguides⁶⁵ or quarter-wave mica plates^{34, 41, 54, 87, 88}, were used to produce CP MW. Similar results were observed regardless the way of producing the MW of different polarizations.

Pre-irradiation of *E. coli* cells to X-rays inverted the sign of effective polarization^{34, 54}. This inversion was observed for two different resonances, 41.32 and 51.76 GHz. Neither resonance frequencies, nor half-widths of the resonance changed during the inversions in effective CPs. The effects of left- and right-handed CP MW become the same at 50 cGy³⁴. At this dose, about one single stranded DNA break per haploid genome was induced. X-ray-induced DNA breaks result in relaxation of the supercoiled DNA-domains. It is known that the majority of DNA in living cells has a right-handed helicity (B-form) but a minor part, in order of 1 %, may alternate from the B-form with the form of left-handed helix (Z-form). Supercoiling is connected with transitions between right B-form to left Z-form in these DNA sequences. Therefore, the data suggested that difference in biological effects of polarized MW might be connected with DNA helicity and supercoiling of DNA-domains.

Supercoiling of DNA-domains is changed during cell cycle because of transcription, replication, repair, and recombination. It can also be changed by means of DNA-specific intercalators such as ethidium bromide (EtBr). EtBr changes supercoiling and facilitates the transition of DNA sequences from Z-form to B-form. Preincubation of *E. coli* AB1157 cells with EtBr inverted the effective polarization at the resonance frequency of 51.755 GHz and right-handed MW became more effective than left polarization⁸⁷. EtBr changed the supercoiling of DNA-domains starting at a concentration of 1 µg/ml as measured with the AVTD in different cell types including *E. coli*^{35, 37, 89}. These data provided further evidence that DNA may be a target for the NT MW effects.

The effects of MW on conformation of nucleoids in *E. coli* cells have recently been studied at the power flux density of $100 \mu\text{W}/\text{cm}^2$ ⁹⁰. Linearly polarized MW resulted in significant effects within specific frequency windows of resonance type in the range of 51-52 GHz. The distances between frequency windows were about 55-180 MHz. Only one of the two possible circular polarizations, left-handed or right-handed, was effective at each frequency window. The sign of effective circular polarization alternated between frequency windows.

While most data on polarization have been obtained by the same research group^{34, 41, 43, 54, 56, 65, 87, 88, 90-92}, recent data of others corroborated our findings at least partially⁹³. These authors analyzed the condensation of chromatin in human buccal epithelium cells by the method of vital indigo carmine staining. MW induced chromatin condensation in dependence on polarization⁹³.

Obviously, the difference in effects of right- and left polarizations could not be explained by the heating or by the mechanism dealing with "hot-spots" due to unequal SAR distribution. The data about the difference in effects of differently polarized MW, the inversion of effective circular polarization between resonances and after irradiation of cells with X-rays and incubation with EtBr provided strong evidence for the non-thermal mechanisms of MW effects. These data suggested chiral asymmetry in the target for the NT MW effects, one of which is presumably chromosomal DNA³⁴, and selection rules on helicity if quantum-mechanical approach is applied⁵⁴.

Electromagnetic environment

Hypothetically, background EMF might be of importance for the MW effects. This hypothesis is based on the experimental observations that SMF, ELF magnetic fields, and MW at low intensities induced similar effects in cells under specific conditions of exposure^{1, 39, 94-96}. Despite very little has been achieved for mechanistic explanation of such effects, there are attempts to consider the effects of EMF in a wide frequency range in the frames of the same physical models⁹⁷⁻¹⁰³.

Litovitz and colleagues found that the ELF magnetic noise inhibited the effects of MW on ODC in L929 cells⁷². The ODC enhancement was found to decrease exponentially as a function of the noise root mean square amplitude. With 60 Hz amplitude-modulated MW, complete inhibition was obtained with noise levels at or above $2 \mu\text{T}$. With the DAMPS (Digital Advanced Mobile Phone System) cellular phone MW, complete inhibition occurred with noise levels at or above $5 \mu\text{T}$. Further studies by the same group revealed that the superposition of ELF noise inhibited hypoxia de-protection caused by long term repeated exposures of chick embryos to MW¹⁰⁴.

The effect of a magnetic noise on microwave-induced spatial learning deficit in the rat was investigated by Lai¹⁰⁵. Rats were exposed to MW (2450 MHz CW, PD $2 \text{ mW}/\text{cm}^2$, average whole-body SAR $1.2 \text{ W}/\text{kg}$) alone or in combination with noise exposure (60 mG). Microwave-exposed rats had significant deficit in learning. Exposure to noise alone did not significantly affect the performance of the animals. However, simultaneous exposure to noise significantly attenuated the microwave-induced spatial learning deficit. The author concluded that simultaneous exposure to a temporally incoherent magnetic field blocks MW-induced spatial learning and memory deficits in the rat¹⁰⁵.

Lai and Singh studied combined effects of a temporally incoherent magnetic noise (45 mG) and MW (CW 2450 MHz, PD $1 \text{ mW}/\text{cm}^2$, average whole-body SAR of 0.6

W/kg) in rat brain cells¹⁰⁶. MW exposure induced significant DNA breakages as measured with both neutral and alkaline comet assays. Exposure to noise alone did not significantly affect cells. However, simultaneous noise exposure blocked the MW-induced effects.

Yao and colleagues investigated the influence of the GSM-like MW at 1.8 GHz on DNA damage and intracellular reactive oxygen species (ROS) formation in human lens epithelial cells (hLECs)¹⁰⁷. DNA damage examined by alkaline comet assay was significantly increased after 3 W/kg and 4 W/kg radiation, whereas the double-strand breaks (DSB) evaluated by γ -H2AX foci were significantly increased only after 4 W/kg radiation. Significantly elevated intracellular ROS levels were detected in the 3-W/kg and 4-W/kg groups. After exposure to 4 W/kg for 24 hours, hLECs exhibited significant G₀/G₁ arrest. All the effects were blocked when the MW exposure was superposed with a 2 μ T electromagnetic noise. The authors concluded that superposed electromagnetic noise blocks MW-induced DNA damage, ROS formation, and cell cycle arrest.

We have previously reported that resonance effects of MW on *E. coli* cell depend on the magnitude of static magnetic field at the place of MW exposure⁵⁷. This dependence was explained by the model of electron-conformational interactions that also predicted possible shift of resonance frequencies in dependence on SMF³⁵. More recently, Ushakov with co-authors exposed *E. coli* cells to MW at the PD of 10⁻¹⁰ W/cm² and the frequencies of 51.675, 51.755 and 51.835 GHz⁸⁸. In this study, cells were exposed to MW at various values of SMF: 22, 49, 61, or 90 μ T. The authors observed that the effects of MW exposure on the conformation of nucleoids depended on the SMF during exposure.

Gapeev *et al.* analyzed effects of MW (41.85-42.1 GHz, frequency increment 50 MHz, PD 50 μ B τ /cm², 20 min exposure) on synergistic reaction of calcium ionophore A23187 and phorbol ester PMA in activation of the respiratory burst of the peritoneal neutrophils of mice⁷⁹. The MW exposure was performed at various SMF. At a SMF of 50 μ T, the authors observed frequency-dependent inhibition of the synergetic reaction with maximal effect at the frequency of 41.95 GHz. In the same frequency range, frequency-dependent activation of the synergetic reaction with a maximal effect at the frequency of 42.0 GHz was found at a SMF of 95 μ T. The authors concluded that increasing the SMF from 50 to 95 μ T resulted in the inversion of ten MW effects and the shift of the resonance frequency by 50 MHz^{79, 108}. Moreover, these effects of MW at the 41.95 GHz and 42.0 GHz were not found at the SMF of ± 1 , 28.3, 75.5 or 117.3 μ T suggesting that the NT MMW effects may appear only at specific values of SMF^{79, 108}.

The observations on dependence of the NT MW effects on SMF and ELF stray field may be of significant interest for further development of physical theory for the NT MW effects and development of safe mobile communication.

Cell-to-cell interaction in response to NT MW

The effects of NT MW at the resonance frequency of 51.755 GHz on conformation of nucleoids in *E. coli* cells were analyzed with respect to cell density during exposure⁵⁷. The per-cell-normalized effect of MW increased by a factor of 4.7 \pm 0.5 on average as cell density increased by one order of magnitude, from 4 \cdot 10⁷ to 4 \cdot 10⁸ cell/ml. These data suggested a co-operative nature of cell response to MW, which is based on cell-to-cell

interaction during exposure. This suggestion was in line with the observed partial synchronization of cells after exposure to MW.

The co-operative nature of cell response to MW at the resonance frequency of 51.755 GHz was confirmed in further studies with *E. coli* cells^{35,41,58}. In addition, dependence of the per-cell-normalized effect on cell density was found for two other resonances, 51.675 GHz and 51.688 GHz. These data suggested that dependence on cell density during exposure is a general attribute of the resonance response of *E. coli* cells to NT MW. At the cell density of $4 \cdot 10^8$ cells/ml, the average intercellular distance was approximately 13 μm that is 10 times larger than the linear dimensions of *E. coli* cells^{57, 58}. Therefore, no direct physical contact seemed to be involved in the cell-to-cell interaction. Two mechanisms, biochemical and electromagnetic, were considered to account for the co-operative nature in the resonance response to weak EMF in wide frequency range including ELF, MW and ionizing radiation^{57, 109, 110}. The first one, biochemical, is based on release of secondary chemical messengers (ions, radicals, or molecules) by those cells, which were directly targeted. Via diffusion, these messengers can induce response in other cells. The second mechanism, electromagnetic, is based on reemission of secondary photons. According to this mechanism, reemitted photons can induce response in other cells if the intercellular distance is shorter than the length of photon absorption. Our experimental data on MW effects fitted better to the electromagnetic mechanism but a combination of two mechanisms was also possible^{57, 58}. In particular, free radicals with prolonged lifetimes might be involved in the observed cell-to-cell communication during response to EMF¹¹¹.

The absorption length of photons with the frequencies of 10^{12} - 10^{13} Hz corresponds to the intracellular distance at the cell density of $5 \cdot 10^8$ cell/ml, at which saturation in the dependences of EMF effects on cell density was observed^{57,58, 111,112}. Such photons may be involved in cell-to-cell communication according to the electromagnetic mechanism and in agreement with the prediction of Fröhlich that biosystems support coherent excitations within frequency range of 10^{11} - 10^{12} Hz⁴⁴. From this point of view, cell suspension may respond to NT MW as a whole. In this case, the number of the exposed cells should be large enough to facilitate cell-to-cell communication during the responses to MW at specific parameters of exposure such as frequency, modulation, and polarization. Interestingly, the cell density for saturation of both MW and ELF effects was about $5 \cdot 10^8$ cell/ml that is close to cell densities in soft tissues of eukaryotes^{58, 111}. Such density of cells in the tissues may be important for regulation of living systems by electromagnetic cell-to-cell communication. Cellular membranes and DNA have been considered as possible sources of coherent excitations and photons, which may be involved in electromagnetic cell-to-cell communication^{35, 44, 111}.

PD dependences of the MW effect at the 51.755 GHz resonance frequency were considerably different between two cell densities, $4 \cdot 10^7$ cells/ml and $4 \cdot 10^8$ cells/ml³⁵. However, the resonance frequency of 51.755 GHz did not shift with the changes in cell density. The half-width of the 51.755 GHz resonance did not depend on cell density either. Contrary to the 51.755 GHz resonance response, the half-width of the 51.675 GHz resonance depended on cell density⁴¹. The data suggested that intracellular interaction during the NT MW exposures at some specific frequencies might affect sub-cellular targets for NT MW. This target is presumably chromosomal DNA that is organized in the DNA-domains^{34, 92, 97}.

In all studies concerning dependence of the MW effects on cell density, the cells occupied a negligible part of the exposed volume and could not change the absorption

of MW even at the highest cell densities^{35, 41, 57, 58}. Striking difference in the cell responses at various cell densities provided further evidence for non-thermal mechanism of the observed MW effects.

Significant MW effect on synchronization of *Saccharomyces carlsbergensis* yeast cells were observed by Golant and co-authors¹¹³. Exposure to MW at 30 $\mu\text{W}/\text{cm}^2$ and 46 GHz induced synchronization as measured by cell density and bud formation. The authors assumed that MW induced cell-to-cell interaction resulting in the observed synchronization.

Genetic background and cell type

We studied effects of MW on *E. coli* cells of three isogenic strains with different length of chromosomal DNA⁹². Bacterial chromosomal DNA in N99 wild type cells was lengthened by inserting DNA from λ and $\lambda\text{imm}^{434}\text{bio}^{10}$ phages. Lysogenic strains N99(λ) and N99($\lambda, \lambda\text{imm}^{434}\text{bio}^{10}$) obtained were used for MW exposure along with the wild type N99 strain. The response of each strain was studied at 10-17 frequencies within the ranges of 41.24-41.37 GHz and 51.69-51.795 GHz. Clear resonance responses to MW at 10^{-10} W/cm² were observed for each strain in both frequency ranges. Significant shifts of both resonance frequencies were found between strains. The shifted resonances had the same amplitude and half-width as for N99 cells⁹². Upon shifting, no changes in effective circular polarization within each shifted resonance were observed. The shifts in resonance frequencies could not be explained by activity of additional genes inserted with the phage DNA. On the other hand, the theoretical consideration based on oscillations of the DNA-domains regarding a whole nucleoid provided a good correlation between the increasing in the DNA length and the shifts in resonances⁹².

A detailed analysis of MW effects on *E. coli* AB1157 cells at 10^{-10} W/cm² and various frequencies revealed the resonance frequency of 51.755 ± 0.001 GHz³⁵. This value was statistically significantly different from the resonance frequency of 51.765 ± 0.002 in response of *E. coli* N99 cells to MW in the same frequency range³⁵. It should be noted that both strains, AB1157 and N99, are considered as wild type strains. Nevertheless, these strains are different in their genotypes by several specific gene markers^{23, 33}. These data suggested that strains of different origin, even being considered as wild type strains, might have different resonance responses to NT MW.

Stagg with colleagues exposed tissue cultures of transformed and normal rat glial cells to packet-modulated MW (TDMA that conforms to the North American digital cellular telephone standard) at 836.55 MHz¹¹⁴. Results from DNA synthesis assays differed for these two cell types. Sham-exposed and MW-exposed cultures of primary rat glial cells showed no significant differences for either log-phase or serum-starved condition. C6 glioma cells exposed to MW at 5.9 $\mu\text{W}/\text{g}$ SAR (0.9 mW/cm²) exhibited small (20-40%) but significant increases in 38 % of [³H]-thymidine incorporation experiments.

Repacholi with co-authors chronically exposed wild-type mice and E mu-Pim1 transgenic mice, which are moderately predisposed to develop lymphoma spontaneously, to plane-wave pulse-modulated MW at 900 MHz with a pulse repetition frequency of 217 Hz and a pulse width of 0.6 ms¹¹⁵. Incident power densities were 2.6-13 W/m² and SARs were 0.008-4.2 W/kg, averaging 0.13-1.4 W/kg. The lymphoma risk was found to be

significantly higher in the exposed transgenic mice. No effects were seen in the wild type mice.

Markkanen with colleagues found that MW affected the UV-induced apoptosis in *Saccharomyces cerevisiae* yeast cells KFY437 (cdc48-mutant) but did not modify apoptosis in KFY417 (wild-type) cells⁷⁸.

Czyz with colleagues exposed pluripotent embryonic stem (ES) cells of wild-type and deficient for the tumor suppressor p53 to pulse modulated GSM MW at 1.71 GHz¹¹⁶. Two dominant GSM modulation schemes (GSM-217 and GSM-Talk), which generate temporal changes between GSM-Basic (active during talking phases) and GSM-DTX (discontinuous transmission, which is active during listening phases thus simulating a typical conversation), were applied to the cells at and below the ICNIRP safety standards. GSM-217 MW induced a significant upregulation of mRNA levels of the heat shock protein hsp70 of p53-deficient ES cells differentiating in vitro, paralleled by a low and transient increase of c-jun, c-myc, and p21 levels in p53-deficient, but not in wild-type cells. These data substantiated the notion that the genetic background determines cellular responses to GSM MW.

Human cultured fibroblasts of three different donors and three different short-term human lymphocyte cultures were exposed to UMTS-like MW at 1950 MHz and the SAR below safety limit of 2 W/kg by Schwarz *et al.*¹¹⁷. The alkaline comet assay and the micronucleus assay were used to analyze genotoxic effects. UMTS exposure increased the comet tail factor (CTF) and induced centromere-negative micronuclei in human cultured fibroblasts in a dose and time-dependent way. No UMTS effect was obtained with lymphocytes, either unstimulated or stimulated with phytohemagglutinin. The authors concluded that UMTS exposure may cause genetic alterations in some but not in all human cells in vitro.

Hoyto *et al.*¹¹⁸, analyzed the effects of MW exposure on cellular ornithine decarboxylase (ODC) activity in fibroblasts, two neural cell lines and primary astrocytes. Several exposure times and exposure levels were used, and the fields were either unmodulated or GSM-like-modulated. Murine L929 fibroblasts, rat C6 glioblastoma cells, human SH-SY5Y neuroblastoma cells, and rat primary astrocytes were exposed to RF radiation at 872 MHz in a waveguide exposure chamber equipped with water cooling. Cells were exposed for 2, 8, or 24 hours to CW MW or to a GSM type signal pulse modulated at 217 Hz. ODC activity in rat primary astrocytes was decreased statistically significantly and consistently in all experiments performed at two exposure levels (1.5 and 6.0 W/kg) and using GSM modulated or CW radiation. In the secondary cell lines, ODC activity was generally not affected. The authors concluded that ODC activity was affected by MW exposure in rat primary neural cells, but the secondary cells used in this study showed essentially no response. In further studies by the same group, the difference in response of human SH-SY5Y neuroblastoma and mouse L929 fibroblast cells to a GSM-modulated MW at 872 MHz was documented⁸⁴.

Nylund and Leszczynski have examined cell response to MW (900 MHz GSM-like signal, average SAR of 2.8 W/kg) using two human endothelial cell lines: EA.hy926 and EA.hy926v1¹¹⁹. Gene expression changes were examined using cDNA Expression Arrays and protein expression changes were examined using 2-DE and PDQuest software. The same genes and proteins were differently affected by exposure in each of the cell lines.

Remondini *et al.* analyzed changes in gene expression in six human cell lines by gene microarrays⁵³. Cells were exposed to MW at 900 MHz GSM Basic mode, SAR 1.8-2.5

W/kg, 1 h exposure. Most cell lines responded to GSM-900 MHz, except for the CHME5 human microglial cells.

Zhao *et al.* studied whether expression of genes related to cell death pathways are dysregulated in primary cultured neurons and astrocytes by exposure to MW from GSM cell phone at the frequency of 1900 MHz for 2 h¹²⁰. Microarray analysis and real-time RT-PCR have shown up-regulation of caspase-2, caspase-6 and Asc (apoptosis associated speck-like protein containing a card) gene expression in neurons and astrocytes. Up-regulation occurred in both “on” and “stand-by” modes in neurons, but only in “on” mode in astrocytes. Additionally, astrocytes showed up-regulation of the Bax gene. The authors concluded that even relatively short-term exposure to the cell phone can up-regulate elements of apoptotic pathways in cells derived from the brain, and that neurons appear to be more sensitive to this effect than astrocytes.

Finally, it follows from the emerging data that MW effects are defined by the genotype and may be cell-type and cell-line dependent. These dependences may explain, at least partly, the discrepancies among replication studies from different laboratories.

Gender- and age-related differences

There are studies indicating that MW may exert a gender-related influence on brain activity¹²¹⁻¹²³. Papageorgiou and co-authors investigated the gender-related influence of MW similar to that emitted by GSM900 mobile phones on brain activity¹²¹. Baseline EEG energy of males was greater than that of females, and exposure to MW decreased EEG energy of males and increased that of females. Memory performance was invariant to MW exposure and gender influences. Smythe and Costall reported the effects of mobile phone exposure on short- and long-term memory in male and female subjects¹²². The results showed that males exposed to an active phone made fewer spatial errors than those exposed to an inactive phone condition, while females were largely unaffected. These results further indicated that mobile phone exposure has functional consequences for human subjects, and these effects appear to be gender-dependent. Nam and colleagues exposed volunteers of both gender to MW emitted by a CDMA cellular phone for half an hour¹²³. Physiological parameters such as systolic and diastolic blood pressures, heart rate, respiration rate, and skin resistance were simultaneously measured. All the parameters for both groups were unaffected during the exposure except for decreased skin resistance of the male subjects¹²³.

Prevalence of women (usually around 70%) among subjects, which report hypersensitivity to electromagnetic fields of wide frequency range including MW, may also be considered as an indirect evidence for the gender-dependent effects of MW.

In his pioneering study concerning age in cancer risk from MW exposure, Hardell and colleagues found that the highest risks were associated with >5-year latency period in the 20-29-year age group for analog phones (OR = 8.17, 95% CI = 0.94-71), and cordless phones (OR = 4.30, 95% CI = 1.22-15)¹²⁴. Of note, no participants of age less 20 years were involved on this study. In further studies from the Hardell's group, highest risk was found in the age group <20 years at time of first use of wireless phones^{125, 126}.

Nam with co-authors reported that skin resistance in teenagers decreased by exposure to CDMA MW from cellular phones whereas no effects were seen in adults¹²³.

Individual differences

We observed significant individual variations in effects of GSM and UMTS MW on chromatin conformation and 53BP1/ γ -H2AX DNA repair foci in studies with lymphocytes from hypersensitive to EMF subjects and healthy persons^{38-40, 49}.

Shckorbatov with colleagues investigated electrokinetic properties of cell nuclei and condensation of heterochromatin in human buccal epithelium cells in response to MW at 42.2 GHz¹²⁷. MW exposure decreased electric charge of cell nuclei and an increased chromatin condensation in dependence on individual traits of donors¹²⁷.

Hinrikus *et al.*⁸³ evaluated the effects of pulse-modulated MW (450 MHz) on human EEG rhythms. Thirteen healthy volunteers were exposed to MW; the field power density at the scalp was 0.16 m W/cm². Differences were found in individual sensitivity to exposure. Increases in the EEG beta power appeared statistically significant in the case of four subjects. In other study, the same authors confirmed and extended their observations on individual sensitivity to exposure with pulse-modulated MW¹²⁸. The experiments were carried out on four different groups of healthy volunteers. A 450-MHz MW modulated at 7 Hz (first group), 14 and 21 Hz (second group), 40 and 70 Hz (third group), 217 and 1000 Hz (fourth group) frequencies was applied. MW exposure, SAR 0.303 W/kg, increased the EEG energy. The proportion of subjects significantly affected was similar in all groups except for the 1000 Hz group: in the first group 16% at 7 Hz modulation; in the second group 31% at 14 Hz modulation and 23% at 21 Hz modulation; in the third group 20% at 40 Hz and 13% at 70 Hz modulation; in the fourth group 16% at 217 Hz and 0% at 1000 Hz modulation frequency.

Zotti-Martelli with colleagues exposed peripheral blood lymphocytes from nine different healthy donors for 60, 120 and 180 min to CW MW with a frequency of 1800 MHz and PD of 5, 10, and 20 mW/cm² and analyzed DNA damage using micronucleus (MN) assay¹²⁹. Both spontaneous and induced MN frequencies varied in a highly significant way among donors, and a statistically significant increase of MN, although rather low, was observed dependent on exposure time and PD. The data analysis highlighted a wide inter-individual and reproducible variability in the response.

Sannino *et al.* evaluated the induction of micronuclei in response to MW (900 MHz, average SAR of 1.25 W/kg) exposure and subsequent treatment with mitomycin C in peripheral blood lymphocytes from five human volunteers¹³⁰. MW exposure reduced the level of mitomycin C –induced micronuclei in cells collected from four donors (i.e., responders). However, the effect of MW was not observed in the remaining donor (i.e., non-responder). The overall data indicated the existence of heterogeneity in the MW response among individuals.

Physiological variables

The importance of physiological variables, which may include all conditions of cell culture growth such as aeration, the composition of the growth and exposure media, on NT MW effects has previously been reviewed⁸.

In our investigations, *E. coli* cells were exposed to CP or LP MW (100 μ W/cm²) at the resonance frequencies of 41.32 GHz and 51.76 GHz^{56, 57}. Both value and direction of the MW effects strongly depended on the phase of culture growth. At logarithmic phase of growth, MW resulted in condensation of nucleoids. In contrast, MW exposure decon-

densed nucleoids in cells if exposure was performed at the stationary phase of growth. It is known, that the state of nucleoid condensation depends on cell activity. In stationary cells nucleoids are more condensed compared to logarithmic cells that divide actively. We concluded that MW are able to either stimulate or inhibit activity of the cells in dependence on stage of growth, stationary or logarithmic, respectively. Higher variability in effects was observed for logarithmic phase and effects were more stable for the stationary phase that is characterized by partial synchronization of cells^{56, 57}. There was no effect at all if cells were exposed at the end of the logarithmic phase where the MW effects changed their direction from inhibition to stimulation⁵⁷. Another peculiarity was observed at the very beginning of the logarithmic stage, where the condensation of chromatin induced by MW was very weak. The AVTD data were confirmed by the electrophoretic analysis of proteins bound to DNA⁵⁶. The main feature of the effect in the stationary phase was a decrease in the quantity of several unidentified DNA-bound proteins with molecular weights of 61, 59, 56, 26, and 15 kDa. In contrast, the main trend was an increase in some proteins, 61, 56, 51 and 43 kDa after exposure at the logarithmic phase. The decrease or increase in the level of proteins bound to DNA correlated with the observed changes in the state of nucleoids, decondensation or condensation, respectively.

The MW effects was studied both at stationary and logarithmic phase of growth during exposure to MW in the PD range of 10^{-18} to $3 \cdot 10^{-3}$ W/cm² at various cell densities⁵⁸. Relatively weak response to MW was observed in exponentially growing cells. Partially synchronized stationary cells were more sensitive, especially at the cell densities above 10^8 cell/ml. The data suggested that the co-operative responses of cells to MW vary in dependence on phase of growth.

Recent data by Ushakov and colleagues indicated that the MW effects on *E. coli* cells depended on concentration of oxygen in the cell suspension during exposure⁸⁸. This dependence might suggest that oxygen concentration should be indicated in order to improve reproducibility in replication studies.

Similar to the effects of ELF⁹⁵, the MW effects were reported to depend on concentration of divalent ions⁷⁹.

Antioxidants and radical scavengers inhibit effects of MW

Lai and Singh described effects of MW on the rat brain cells as measured using a microgel electrophoresis assay¹³¹. These effects were significantly blocked by treatment of rats either with the spin-trap compound N-tert-butyl- α -phenylnitron or with melatonin that is a potent free radical scavenger and antioxidant¹³². These data suggested that free radicals might be involved in the effects of MW.

Oktem and colleagues exposed rats to MW from GSM900 mobile phone with and without melatonin treatment¹³³. Malondialdehyde (MDA), an index of lipid peroxidation, and urine N-acetyl-beta-d-glucosaminidase (NAG), a marker of renal tubular damage, were used as markers of oxidative stress-induced renal impairment. Superoxide dismutase (SOD), catalase (CAT), and glutathione peroxidase (GSH-Px) activities were studied to evaluate changes in antioxidant status. In the MW-exposed group, while tissue MDA and urine NAG levels increased, SOD, CAT, and GSH-Px activities were reduced. Melatonin treatment inhibited these effects. The authors concluded that melatonin might exhibit a protective effect on mobile phone-induced renal impairment in rats.

Ozguner and colleagues exposed Wistar-Albino rats to MW from GSM900 mobile phone with and without melatonin and analyzed histopathologic changes in skin¹³⁴. MW induced increase in thickness of stratum corneum, atrophy of epidermis, papillomatosis, basal cell proliferation, granular cell layer (hypergranulosis) in epidermis and capillary proliferation. Impairment in collagen tissue distribution and separation of collagen bundles in dermis were all observed in exposed animals as compared to the control group. Most of these changes, except hypergranulosis, were prevented with melatonin treatment. The authors concluded that exposure to GSM900 MW caused mild skin changes and melatonin treatment could reduce these changes. In other studies of the same group, the ability of melatonin to reduce various MW-induced effects was confirmed and inhibitory potential of the antioxidant caffeic acid phenethyl ester (CAPE) was reported¹³⁵⁻¹³⁸.

Ayata *et al.* analyzed the effects of 900 MHz MW with and without melatonin on fibrosis, lipid peroxidation, and anti-oxidant enzymes in rat skin¹³⁹. The levels of MDA and hydroxyproline and the activities of SOD, GSH-Px, and CAT were studied. MDA and hydroxyproline levels and activities of CAT and GSH-Px were increased significantly in the exposed group without melatonin and decreased significantly in the exposed group with melatonin. SOD activity was decreased significantly in the exposed group and this decrease was not prevented by the melatonin treatment. The authors assumed that the rats irradiated with MW suffer from increased fibrosis and lipid peroxidation and that melatonin can reduce the fibrosis and lipid peroxidation caused by MW.

Ilhan with co-authors investigated oxidative damage in brain tissue of rats exposed to GSM900 MW with and without pretreatment with Ginkgo biloba (Gb)¹⁴⁰. MW induced oxidative damage measured as: (i) increase in MDA and nitric oxide (NO) levels in brain tissue, (ii) decrease in brain SOD and GSH-Px activities, and (iii) increase in brain xanthine oxidase and adenosine deaminase activities. These MW effects were prevented by the Gb treatment. Furthermore, Gb prevented the MW-induced cellular injury in brain tissue revealed histopathologically. The authors concluded that reactive oxygen species may play a role in the adverse effects of GSM900 MW and Gb prevents the MW-induced oxidative stress by affecting antioxidant enzymes activity in brain tissue.

Koylu *et al.* studied the effects of MW on the brain lipid peroxidation in rats, and the possible protective effects of melatonin on brain degeneration induced by MW¹⁴¹. The levels of lipid peroxidation in the brain cortex and hippocampus increased in the MW group compared with the control group, although the levels in the hippocampus were decreased by combined administration of MW and melatonin. Brain cortex lipid peroxidation levels were unaffected by melatonin treatment. The authors concluded that melatonin may prevent MW-induced oxidative stress in the hippocampus by strengthening the antioxidant defense system.

Sokolovic *et al.*¹⁴² evaluated the intensity of oxidative stress in the brain of Wistar rats chronically exposed to MW from mobile phones (SAR = 0.043-0.135 W/kg) during 20, 40 and 60 days. A significant increase in brain tissue malondialdehyde (MDA) and carbonyl group concentration was found. Decreased activity of catalase (CAT) and increased activity of xanthine oxidase (XO) remained after 40 and 60 days of MW exposure. Melatonin treatment significantly prevented the increases in MDA content and XO activity in the brain tissue after 40 days of exposure while it was unable to prevent the decrease of CAT activity and increase of carbonyl group contents. The authors

concluded that exposure to the mobile phone MW caused oxidative damage in the brain and that treatment with melatonin significantly prevented this oxidative damage.

To conclude this section, several studies suggest that supplementation with antioxidants and radical scavengers can reduce MW effects.

Summary of experimental studies

Numerous experimental data have provided strong evidence for NT MW effects and have also indicated several regularities in appearance of these effects: dependence on frequency within specific frequency windows of “resonance-type”; narrowing of the frequency windows with decreasing intensity; dependence on modulation and polarization; sigmoid dependence on intensity within specific intensity windows including super-low PD comparable to intensities from base stations; thresholds in intensity and exposure time (coherence time); dependence on duration of exposure and post-exposure time; dependence on cell density that suggests cell-to-cell interaction during response to NT MW; dependence on physiological conditions during exposure, such as stage of cell growth, concentration of oxygen and divalent ions, activity of radicals; dependence on genotype; cell-type and cell-line dependence; gender-, age- and individual differences; and SMF and EMF stray field during exposure may be of importance for the effects of NT MW.

Replication studies

Obviously, not taking into account the dependences of NT MW effects on a number of physical parameters and biological variables may result in misleading conclusions regarding the reproducibility of these effects. Especially important might be the observations that NT MW could inhibit or stimulate the same functions dependent on conditions of exposure². Under different conditions of exposure, MW either increased or decreased the growth rate of yeast cells⁸, the radiation-induced damages in mice¹⁴¹, the respiratory burst in neutrophils of mice⁷⁹, the condensation of nucleoids in *E. coli* cells^{56, 57} and human lymphocytes⁴⁰. Potentially bi-directional effects of MW should be taken into account in replication studies.

Despite of considerable body of studies with NT MW in biology, only a few studies were performed to replicate the original data on the NT MW effects. It should be noted, that these replications are usually not completely comparable with the original studies because of either missing description of important parameters of exposure or significant differences in these parameters between original study and replication.

One well-known attempt to replicate the results of Gründler was the study by Gos and co-authors¹⁴⁴. No MW effects were observed in this replication study. However, the deviations from the Gründler’s protocol might be a simple reason for poor reproducibility. For example, synchronized cells were used in studies of Gründler. Contrary to the Gründler’s original protocol, Gos used exponentially growing cells. If the MW effects in yeast cells are dependent on stage of growth, cell density and intercellular interactions as it has been described for *E. coli* cells^{35, 41, 56, 57}, no response should be expected in the logarithmic phase of growth. Gos and colleagues used *S. cerevisiae* strain with the auxotrophy mutations for leucine and uracil. Gründler used the wild type strain. It might suggest another cause for the deviations between the data of Gründler and Gos. Despite

orientation of SMF in respect to electric and magnetic components of MW was the same, the values of SMF were different. The stray ELF field was 120 nT in the study by Gos, that is higher than usually observed background fields, < 50 nT. The spectral characteristics of the background fields, which were described only in the study by Gos, might be also different. In addition, the conditions of cell cultivation might vary between studies; for example, the data on oxygen concentration in media used in both studies are not available.

Amount of already known physical and biological variables that are important for reproducibility of NT MW effects seem to be far beyond the limits of usually controlled parameters in biological experiments. The knowledge of some of these variables is based on consistent findings following from experimental studies of different research groups. Further evaluation of variables that are important for the NT MW effects would benefit from the developing of the physical and molecular biological models for the MW effects.

Most reviews of the experimental studies do not include analysis of various biological variables and physical parameters when comparing the data on NT MW effects from different studies. As result, misleading conclusion is often made that MW at NT levels produce no “reproducible” effects.

Possible mechanisms

Analyzing theoretically our experimental data on the MW effects at super-low intensities we concluded that these effects should be considered using quantum-mechanical approach⁵⁷. Reanalysis of our data by Binhi resulted to the same conclusion⁹⁷. This is in line with the fundamental quantum-mechanical mechanism that has been suggested by Fröhlich¹⁴⁵. Most probably, the physical mechanisms of the NT MW effects must be based on quantum-mechanical approach and physics of non-equilibrium and nonlinear systems^{44, 98, 146-148}.

Our data indicated also that chromosomal DNA is a target for interaction with MW^{34, 87, 92}. The length of genomic DNA is much longer than the dimension of surrounding compartment. For example, there is about 1.8 m of DNA in a human genome that is compacted in interaction with other compounds such as proteins, RNA and ions to fit into a nucleus with a characteristic diameter of 5-10 μm . Importantly, concentration of DNA in the nuclei is higher than in crystallization solutions for DNA, 50-100 mM versus 10-30 mM, respectively. Whether DNA is organized in nuclei as a liquid crystal remains to be investigated. However, it is clear that DNA in a living cell cannot be considered as an aqueous solution of DNA molecules in a thermodynamic equilibrium.

The quantum-mechanical physical model for primary interaction of MW with DNA has been proposed¹⁴⁹. We hypothesized that genomic DNA contain two different codes¹⁰⁹. The first one is the well-known genetic triplet code for coding the genes. The second one is a “physical code” that determine the spectrum of natural oscillations in chromosomal DNA including electromagnetic, mechanical and acoustic oscillations, which are hypothetically responsible for regulation of gene expression at different stages of ontogenesis and for genomic rearrangements in evolution¹⁰⁹. The physical model describing these coupled oscillations in chromosomal DNA has been proposed⁹². This model helps to resolve the so-called C-paradox that addresses the issue of a genome size, so-called C-value. Only few percent of DNA encodes genes in almost all eukaryotic genomes. The same amount of DNA is involved in regulation of gene expression by known biochemical mechanisms. The function of the rest of DNA, which does not depend on complexity

of eukaryotic species and is represented by noncoding repetitive DNA sequences, is not understood in molecular biology providing a basement for hypotheses such as “junk DNA”. The function of this major part of genomic DNA became clear given that the whole genomic DNA is responsible for the creation of the natural spectrum of oscillations that is hypothetically a main characteristic of each biological species¹⁰⁹.

The understanding of mechanisms for the NT MW effects is far from comprehensive. Many questions remain to be addressed such as whether resonance effects of MW depend on electromagnetic noise and SMF during exposure.

Urgent needs and further perspectives

At present, new situation arose when a significant part of the general population is exposed chronically (much longer than previously investigated durations of exposures) to NT MW from different types of mobile communication including GSM and UMTS/3G phones and base stations, WLAN (Wireless Local Area Networks), WPAN (Wireless Personal Area Networks such as Bluetooth), DECT (Digital Enhanced (former European) Cordless Telecommunications) wireless phones. It should be anticipated that some part of the human population, such as children, pregnant women and groups of hypersensitive persons could be especially sensitive to the NT MW exposures.

Multiple sources of mobile communication result in chronic exposure of significant part of general population to MW at the non-thermal levels. Therefore, the ICNIRP safety standards, which are based on thermal effects in acute exposures, cannot protect the general population from the chronic exposures to NT MW from mobile communication¹³.

Most of the real signals that are in use in mobile communication have not been tested so far. Very little research has been done with real signals and for durations and intermittences of exposure that are relevant to chronic exposures from mobile communication. In some studies, the so-called “mobile communication-like” signals were investigated that in fact were different from the real exposures in such important aspects as intensity, carrier frequency, modulation, polarization, duration and intermittence. How relevant such studies to evaluation of adverse health effects from MW of mobile communication is not known.

Emerging evidence suggests that the SAR concept, which has been widely adopted for safety standards, may not be useful alone for the evaluation of health risks from MW of mobile communication. How the role of other exposure parameters such as frequency, modulation, polarization, duration, and intermittence of exposure should be taken into account is an urgent question to solve. Solving this question would greatly benefit from the knowledge of the physical mechanisms of the NT MW effects.

So far, most laboratory and epidemiological studies did not control important features of the NT MW effects as described above and therefore, only limited conclusion regarding health effects of MW from mobile communication can be drawn from these studies. It should be noted that one group of epidemiologists with a long-lasting experience in studying relationship between mobile phone usage and cancer risk have consistently been concerned regarding importance of various MW signals and exposure durations^{19, 150-152}. The group of Hardell was the first epidemiologic group in attempting to study separately the MW signals from cordless phones, analogue phones and digital phones. As a rule, analogue phones had the highest association with the cancer risk. Cordless phones were associated with the risk for brain tumors, acoustic neuroma, and

T-cell lymphoma stronger or in the same degree as digital and analogue phones despite significantly lower SAR values were produced by cordless phones^{17, 19, 151, 152}. It should be also noted that epidemiological data are controversial and methodological differences are a subject of debates between various research groups^{17, 153}. However, the approach of Hardell's group is more valid from the mechanistic point of view and this should be taken into account when comparing with results of other groups that ignore or minimize the complex dependencies of the NT MW effects on several parameters/variables.

The data about the effects of MW at super low intensities and significant role of duration of exposure in these effects along with the data showing that adverse effects of NT MW from GSM/UMTS mobile phones depend on carrier frequency and type of the MW signal suggest that MW from base-stations/masts can also produce adverse effects at prolonged durations of exposure and encourage the mechanistic *in vitro* studies using real signals from base stations/masts. Further investigations with human primary cells under well controlled conditions of exposure, including all important parameters as described above, are urgently needed to elucidate possible adverse effects of MW signals that are currently being used in wireless communication, especially in new technologies such as UMTS mobile telephony.

The dependence of adverse effects of NT MW from GSM/UMTS mobile phones on carrier frequency and type of signal should be taken into account in settings of safety standards and in planning of *in vivo* and epidemiological studies. Of note, the data from epidemiological studies should be treated with care. Indeed, it is almost impossible to select control unexposed groups because the whole population in many countries is exposed to wide range of MW signals from various sources such as mobile phones and base stations/masts of various kinds, WLAN, WPAN, DECT wireless phones and given that duration of exposure (must be at least 10 years for cancer latency period) may be more important for the adverse health effects of NT MW than PD/SAR. From this point of view, current epidemiological studies may be either inconclusive, if results are negative, or may underestimate the hazard of MW exposure, if results are positive.

The joined efforts of scientific groups within national or international programs are needed for mechanistic studies of the NT MW effects. In order to take into account all necessary physical parameters and biological variables, these programs should involve scientists with long-lasting experience in studying NT MW effects.

Because NT MW affect not only brain cells, but also blood cells^{38-40, 75}, skin and fibroblasts^{68, 69, 134, 154}, stem cells^{67, 116, 155}, reproductive organs and sperm quality¹⁵⁶⁻¹⁵⁹ the using of hands-free cannot minimize all adverse health effects. Possibilities to minimize the adverse effects of NT MW using various biophysical and biochemical approaches should be studied.

Identification of those signals and frequency channels/bands for mobile communication, which do not affect human cells, is needed as a high priority task for the development of safe mobile communication.

Acknowledgements

Financial supports from the Swedish Council for Working Life and Social Research, the Swedish Radiation Protection Authority, the National Scholarship Program of the Slovak Republic, and the Russian Foundation for Basic Research are gratefully acknowledged.

References

1. Belyaev IY, Shcheglov VS, Alipov ED, *et al.* Non-thermal effects of extremely high frequency microwaves on chromatin conformation in cells in vitro: dependence on physical, physiological and genetic factors. *IEEE Transactions on Microwave Theory and Techniques* 2000; 48: 2172-9.
2. Pakhomov AG, Akyl Y, Pakhomova ON, *et al.* Current state and implications of research on biological effects of millimeter waves: a review of the literature. *Bioelectromagnetics* 1998; 19: 393-413.
3. Lai H. Biological effects of radiofrequency electromagnetic field. In: Wnek GE, Bowlin GL, eds. *Encyclopedia of Biomaterials and Biomedical Engineering*. New York, NY: Marcel Dekker, 2005, 1-8.
4. Betskii OV, Devyatkov ND, Kislov VV. Low intensity millimeter waves in medicine and biology. *Crit Rev Biomed Eng* 2000; 28: 247-68.
5. Adey WR. Cell and molecular biology associated with radiation fields of mobile telephones. In Stone WR, Ueno S, eds. *Review of Radio Science, 1996-1999*. Oxford: Oxford University Press, 1999, 845-72.
6. Banik S, Bandyopadhyay S, Ganguly S. Bioeffects of microwave - a brief review. *Bioresour Technol* 2003; 87: 155-9.
7. Devyatkov ND, Golant MB, Betskij OV. Peculiarities of usage of millimeter waves in biology and medicine (in Russian). IRE RAN. 1994. Moscow.
8. Gründler W, Jentzsch V, Keilmann F, *et al.* Resonant cellular effects of low intensity microwaves. In: Frölich H, ed. *Biological coherence and response to external stimuli*. Berlin: Springer-Verlag, 1988, 65-85.
9. Iskin VD. Biological effects of millimeter waves and correlation method of their detection (in Russian). *Osnova*, Kharkov, 1990.
10. Grigoriev YG. Bioeffects of modulated electromagnetic fields in the acute experiments (results of Russian researches). In: *Annual of Russian National Committee on Non-Ionising Radiation Protection*. Moscow: ALLANA, 2004, 16-73.
11. Grigoriev YG, Stepanov VS, Nikitina VN, *et al.* ISTC Report. Biological effects of radiofrequency electromagnetic fields and the radiation guidelines. Results of experiments performed in Russia/Soviet Union. Institute of Biophysics, Ministry of Health, Russian Federation. Moscow, 2003.
12. Grigoriev Y, Nikitina V, Rubtcova N, *et al.* The Russian National Committee on Non-Ionizing Radiation Protection (RNCNIRP) and the radiation guidelines. In *Transparency Forum for Mobile Telephone Systems*. http://www.ssi.se/ickejoniserande_stralning/mobiltele/transpar/PDF/Semi3_Forsiktigh_gransvar.pdf, Ed. <http://members.chello.se/igor.belyaev/guidelines.pdf>. Stockholm, 2005.
13. ICNIRP. ICNIRP Guidelines. Guidelines for limiting exposure to time-varying electric, magnetic, and electromagnetic fields (up to 300 GHz). *Health Physics* 1998; 74: 494-522.
14. Cook CM, Saucier DM, Thomas AW, *et al.* Exposure to ELF magnetic and ELF-modulated radiofrequency fields: the time course of physiological and cognitive effects observed in recent studies (2001-2005). *Bioelectromagnetics* 2006; 27: 613-27.
15. Pakhomov AG, Murphy MB. Comprehensive review of the research on biological effects of pulsed radiofrequency radiation in Russia and the former Soviet Union. In: Lin JC, ed. *Advances in Electromagnetic Fields in Living System*, Vol. 3. New York: Kluwer Academic/Plenum Publishers, 2000, 265-90.
16. Sit'ko SP. The 1st All-Union Symposium with International Participation "Use of Millimeter Electromagnetic Radiation in Medicine". TRC Otklik. Kiev, Ukraine, USSR, 1989, 298.
17. Kundi M, Mild K, Hardell L, *et al.* Mobile telephones and cancer - a review of epidemiological evidence. *J Toxicol Environ Health B Crit Rev* 2004; 7: 351-84.
18. Lonn S, Ahlbom A, Hall P, *et al.* Mobile phone use and the risk of acoustic neuroma. *Epidemiology* 2004; 15: 653-9.
19. Hardell L, Eriksson M, Carlberg M, *et al.* Use of cellular or cordless telephones and the risk for non-Hodgkin's lymphoma. *Int Arch Occup Environ Health* 2005; DOI 10.1007/s00420-005-0003-5.
20. Vilenskaya RL, Smolyanskaya AZ, Adamenko VG, *et al.* Induction of the lethal colicin synthesis in *E. coli* K12 C600 (E1) by means the millimeter radiation (in Russian). *Bull Eksperim Biol Med* 1972; 4: 52-4.

21. Devyatkov ND. Influence of electromagnetic radiation of millimeter range on biological objects (in Russian). *Usp Fiz Nauk* 1973; 116: 453-4.
22. Webb SJ. Factors affecting the induction of Lambda prophages by millimetre waves. *Phys Letts* 1979; 73A: 145-8.
23. Lukashovsky KV, Belyaev IY. Switching of prophage lambda genes in *Escherichia coli* by millimeter waves. *Medical Science Research* 1990; 18: 955-7.
24. Golant MB. Resonance effect of coherent millimeter-band electromagnetic waves on living organisms (in Russian). *Biofizika* 1989; 34: 1004-14.
25. Postow E, Swicord ML. Modulated fields and "window" effects. In: Polk C, Postow E, eds. *CRC Handbook of Biological Effects of Electromagnetic Fields*. Boca Raton, FL: CRC Press, 1986, 425-60
26. Belyaev IY. Some biophysical aspects of the genetic effects of low intensity millimeter waves. *Bioelectrochem Bioenerg* 1992; 27: 11-8.
27. Hyland GJ. Physics and biology of mobile telephony. *Lancet* 2000; 356: 1833-6.
28. Blackman CF, Benane SG, Joines WT, *et al.* Calcium-ion efflux from brain tissue: power-density versus internal field-intensity dependencies at 50-MHz RF radiation. *Bioelectromagnetics* 1980; 1: 277-83.
29. Blackman CF, Benane SG, Elder JA, *et al.* Induction of calcium-ion efflux from brain tissue by radiofrequency radiation: effect of sample number and modulation frequency on the power-density window. *Bioelectromagnetics* 1980; 1: 35-43.
30. Joines WT, Blackman CF. Power density, field intensity, and carrier frequency determinants of RF-energy-induced calcium-ion efflux from brain tissue. *Bioelectromagnetics* 1980; 1: 271-5.
31. Adey WR, Bawin SM, Lawrence AF. Effects of weak amplitude-modulated microwave fields on calcium efflux from awake cat cerebral cortex. *Bioelectromagnetics* 1982; 3: 295-307.
32. Lin-Liu S, Adey WR. Low frequency amplitude modulated microwave fields change calcium efflux rates from synaptosomes. *Bioelectromagnetics* 1982; 3: 309-22.
33. Belyaev IY, Alipov YD, Shcheglov VS, *et al.* Resonance effect of microwaves on the genome conformational state of *E. coli* cells. *Z Naturforsch [C]* 1992; 47: 621-7.
34. Belyaev IY, Alipov YD, Shcheglov VS. Chromosome DNA as a target of resonant interaction between *Escherichia coli* cells and low-intensity millimeter waves. *Electro- and Magnetobiology* 1992; 11: 97-108.
35. Belyaev IY, Shcheglov VS, Alipov YD, *et al.* Resonance effect of millimeter waves in the power range from 10(-19) to 3 x 10(-3) W/cm² on *Escherichia coli* cells at different concentrations. *Bioelectromagnetics* 1996; 17: 312-21.
36. Belyaev IY, Harms-Ringdahl M. Effects of gamma rays in the 0.5-50-cGy range on the conformation of chromatin in mammalian cells. *Radiat Res* 1996; 145: 687-93.
37. Belyaev IY, Alipov YD, Harms-Ringdahl M. Effects of zero magnetic field on the conformation of chromatin in human cells. *Biochim Biophys Acta* 1997; 1336: 465-73.
38. Markova E, Hillert L, Malmgren L, *et al.* Microwaves from GSM Mobile Telephones Affect 53BP1 and gamma-H2AX Foci in Human Lymphocytes from Hypersensitive and Healthy Persons. *Environ Health Perspect* 2005; 113: 1172-7.
39. Belyaev IY, Hillert L, Protopopova M, *et al.* 915 MHz microwaves and 50 Hz magnetic field affect chromatin conformation and 53BP1 foci in human lymphocytes from hypersensitive and healthy persons. *Bioelectromagnetics* 2005; 26: 173-84.
40. Sarimov R, Malmgren LOG, Markova E, *et al.* Non-thermal GSM microwaves affect chromatin conformation in human lymphocytes similar to heat shock. *IEEE Transactions on Plasma Science* 2004; 32: 1600-8.
41. Shcheglov VS, Belyaev IY, Ushakov VL, *et al.* Power-dependent rearrangement in the spectrum of resonance effect of millimeter waves on the genome conformational state of *E. coli* cells. *Electro- and Magnetobiology* 1997; 16: 69-82.
42. Grundler W. Intensity- and frequency-dependent effects of microwaves on cell growth rates. *Bioelectrochem Bioenerg* 1992; 27: 361-5.
43. Belyaev SY, Kravchenko VG. Resonance effect of low-intensity millimeter waves on the chromatin conformational state of rat thymocytes. *Z Naturforsch [C]* 1994; 49: 352-8.
44. Frohlich H. Long-range coherence and energy storage in biological systems. *Int J Quantum Chem* 1968; 2: 641-52.

45. Gapeev AB, Safronova VG, Chemeris NK, *et al.* Inhibition of the production of reactive oxygen species in mouse peritoneal neutrophils by millimeter wave radiation in the near and far field zones of the radiator. *Bioelectrochem Bioenerg* 1997; 43: 217-20.
46. Gapeev AB, Safronova VG, Chemeris NK, *et al.* Modification of the activity of murine peritoneal neutrophils upon exposure to millimeter waves at close and far distances from the emitter. *Biofizika* 1996; 41: 205-19.
47. Gapeev AB, Mikhailik EN, Chemeris NK. Anti-inflammatory effects of low-intensity extremely high-frequency electromagnetic radiation: frequency and power dependence. *Bioelectromagnetics* 2008; 29: 197-206.
48. Gapeev AB, Mikhailik EN, Chemeris NK. Features of anti-inflammatory effects of modulated extremely high-frequency electromagnetic radiation. *Bioelectromagnetics* 2009; 30(6): 454-61.
49. Belyaev IY, Markova E, Hillert L, *et al.* Microwaves from UMTS/GSM mobile phones induce long-lasting inhibition of 53BP1/gamma-H2AX DNA repair foci in human lymphocytes. *Bioelectromagnetics* 2009; 30: 129-41.
50. Tkalec M, Malaric K, Pevalek-Kozlina B. Influence of 400, 900, and 1900 MHz electromagnetic fields on Lemna minor growth and peroxidase activity. *Bioelectromagnetics* 2005; 26: 185-93.
51. Tkalec M, Malaric K, Pevalek-Kozlina B. Exposure to radiofrequency radiation induces oxidative stress in duckweed Lemna minor L. *Sci Total Environ* 2007; 388: 78-89.
52. Tkalec M, Malaric K, Pavlica M, *et al.* Effects of radiofrequency electromagnetic fields on seed germination and root meristematic cells of *Allium cepa* L. *Mutation Research - Genetic Toxicology and Environmental Mutagenesis* 2009; 672: 76-81.
53. Remondini D, Nylund R, Reivinen J, *et al.* Gene expression changes in human cells after exposure to mobile phone microwaves. *Proteomics* 2006; 6: 4745-54.
54. Belyaev IY, Shcheglov VS, Alipov YD. Selection rules on helicity during discrete transitions of the genome conformational state in intact and X-rayed cells of *E.coli* in millimeter range of electromagnetic field. In: Allen MJ, *et al.*, eds. *Charge and Field Effects in Biosystems*. Vol. 3. Basel, Switzerland: Birkhauser, 1992, 115-26.
55. Kolbun ND, Lobarev VE. Problems of bioinformational interaction in millimeter VE range (in Russian). *Kibernet Vychislitel'naya Tekhnika* 1988; 78: 94-9.
56. Belyaev IY, Shcheglov VS, Alipov YD, *et al.* Regularities of separate and combined effects of circularly polarized millimeter waves on *E. coli* cells at different phases of culture growth. *Bioelectrochem Bioenerg* 1993; 31: 49-63.
57. Belyaev IY, Alipov YD, Shcheglov VS, *et al.* Cooperative response of *Escherichia Coli* cells to the resonance effect of millimeter waves at super low intensity. *Electro- and Magnetobiology* 1994; 13: 53-66.
58. Shcheglov VS, Alipov ED, Belyaev IY. Cell-to-cell communication in response of *E. coli* cells at different phases of growth to low-intensity microwaves. *Biochim Biophys Acta* 2002; 1572: 101-6.
59. Oscar KJ, Hawkins TD. Microwave alteration of the blood-brain barrier system of rats. *Brain Res* 1977; 126: 281-93.
60. Persson BRR, Salford LG, Brun A. Blood-Brain Barrier permeability in rats exposed to electromagnetic fields used in wireless communication. *Wireless Networks* 1997; 3: 455-61.
61. Salford LG, Brun A, Stuesson K, *et al.* Permeability of the blood-brain barrier induced by 915 MHz electromagnetic radiation, continuous wave and modulated at 8, 16, 50, and 200 Hz. *Microscopy research and technique* 1994; 27: 535-42.
62. Eberhardt JL, Persson BR, Brun AE, *et al.* Blood-brain barrier permeability and nerve cell damage in rat brain 14 and 28 days after exposure to microwaves from GSM mobile phones. *Electromagn Biol Med* 2008; 27: 215-29.
63. Bozhanova TP, Bryukhova AK, Golant MB. About possibility to use coherent radiation of extremely high frequency for searching differences in the state of living cells. In: Devyatkov ND, ed. *Medical and biological aspects of millimeter wave radiation of low intensity*. Fryazino, USSR, IRE, Academy of Science, 1987, Vol. 280, 90-7.
64. Kwee S, Raskmark P. Changes in cell proliferation due to environmental non-ionizing radiation. 2. Microwave radiation. *Bioelectrochem Bioenerg* 1998; 44: 251-5.
65. Belyaev IY, Shcheglov VS, Alipov YD. Existence of selection rules on helicity during discrete transitions of the genome conformational state of *E.coli* cells exposed to low-level millimeter radiation. *Bioelectrochem Bioenerg* 1992; 27: 405-11.

66. Nikolova T, Czyz J, Rolletschek A, *et al.* Electromagnetic fields affect transcript levels of apoptosis-related genes in embryonic stem cell-derived neural progenitor cells. *Faseb J* 2005; 19: 1686-8.
67. Markova E, Malmgren L, Belyaev I. GSM/UMTS microwaves inhibit 53BP1 DNA repair foci in human stem cells stronger than in differentiated cells: mechanistic link to possible cancer risk. *Environ Health Perspect* 2009 <http://www.ehponline.org/docs/2009/0900781/abstract.html>
68. Litovitz TA, Krause D, Penafiel M, *et al.* The role of coherence time in the effect of microwaves on ornithine decarboxylase activity. *Bioelectromagnetics* 1993; 14: 395-403.
69. Diem E, Schwarz C, Adlkofer F, *et al.* Non-thermal DNA breakage by mobile-phone radiation (1800 MHz) in human fibroblasts and in transformed GFSH-R17 rat granulosa cells in vitro. *Mutat Res* 2005; 583: 178-83.
70. Veyret B, Bouthet C, Deschaux P, *et al.* Antibody responses of mice exposed to low-power microwaves under combined, pulse-and-amplitude modulation. *Bioelectromagnetics* 1991; 12: 47-56.
71. Penafiel LM, Litovitz T, Krause D, *et al.* Role of modulation on the effect of microwaves on ornithine decarboxylase activity in L929 cells. *Bioelectromagnetics* 1997; 18: 132-41.
72. Litovitz TA, Penafiel LM, Farrel JM, *et al.* Bioeffects induced by exposure to microwaves are mitigated by superposition of ELF noise. *Bioelectromagnetics* 1997; 18: 422-30.
73. Byus CV, Lundak RL, Fletcher RM, *et al.* Alterations in protein kinase activity following exposure of cultured human lymphocytes to modulated microwave fields. *Bioelectromagnetics* 1984; 5: 341-51.
74. Byus CV, Kartun K, Pieper S, *et al.* Increased ornithine decarboxylase activity in cultured cells exposed to low energy modulated microwave fields and phorbol ester tumor promoters. *Cancer Res* 1988; 48: 4222-6.
75. d'Ambrosio G, Massa R, Scarfi MR, *et al.* Cytogenetic damage in human lymphocytes following GMSK phase modulated microwave exposure. *Bioelectromagnetics* 2002; 23: 7-13.
76. Huber R, Treyer V, Schuderer J, *et al.* Exposure to pulse-modulated radio frequency electromagnetic fields affects regional cerebral blood flow. *Eur J Neurosci* 2005; 21: 1000-6.
77. Huber R, Treyer V, Borbely AA, *et al.* Electromagnetic fields, such as those from mobile phones, alter regional cerebral blood flow and sleep and waking EEG. *J Sleep Res* 2002; 11: 289-95.
78. Markkanen A, Penttinen P, Naarala J, *et al.* Apoptosis induced by ultraviolet radiation is enhanced by amplitude modulated radiofrequency radiation in mutant yeast cells. *Bioelectromagnetics* 2004; 25: 127-33.
79. Gapeev AB, Iakushina VS, Chemeris NK, *et al.* Modulated extremely high frequency electromagnetic radiation of low intensity activates or inhibits respiratory burst in neutrophils depending on modulation frequency (in Russian). *Biofizika* 1997; 42: 1125-34.
80. Gapeev AB, Yakushina VS, Chemeris NK, *et al.* Modification of production of reactive oxygen species in mouse peritoneal neutrophils on exposure to low-intensity modulated millimeter wave radiation. *Bioelectrochemistry and Bioenergetics* 1998; 46: 267-72.
81. Lopez-Martin ME, Brogains J, Relova-Quinteiro JL, *et al.* The action of pulse-modulated GSM radiation increases regional changes in brain activity and c-Fos expression in cortical and subcortical areas in a rat model of picrotoxin-induced seizure proneness. *Journal of Neuroscience Research* 2009; 87: 1484-99.
82. Lukkonen J, Juutilainen J, Naarala J. Combined effects of 872 MHz radiofrequency radiation and ferrous chloride on reactive oxygen species production and DNA damage in human SH-SY5Y neuroblastoma cells. *Bioelectromagnetics* 2010; (Epub ahead of print).
83. Hinrikus H, Bachmann M, Lass J, *et al.* Effect of 7, 14 and 21 Hz modulated 450 MHz microwave radiation on human electroencephalographic rhythms. *Int J Radiat Biol* 2008; 84: 69-79.
84. Hoyto A, Luukkonen J, Juutilainen J, *et al.* Proliferation, oxidative stress and cell death in cells exposed to 872 MHz radiofrequency radiation and oxidants. *Radiat Res* 2008; 170: 235-43.
85. Franzellitti S, Valbonesi P, Contin A, *et al.* HSP70 expression in human trophoblast cells exposed to different 1.8 Ghz mobile phone signals. *Radiat Res* 2008; 170: 488-97.
86. Bailey J, Chrysostomou A, Hough JH, *et al.* Circular polarization in star-formation regions: implications for biomolecular homochirality. *Science* 1998; 281: 672-4.
87. Ushakov VL, Shcheglov VS, Belyaev IY, *et al.* Combined effects of circularly polarized microwaves and ethidium bromide on *E. coli* cells. *Electro- and Magnetobiology* 1999; 18: 233-42.
88. Ushakov VL, Alipov EA, Shcheglov VS, *et al.* Peculiarities of non-thermal effects of microwaves in the frequency range of 51-52 GHz on *E. coli* cells. *Radiat Biol Radioecol* 2006; 46: 729-34.
89. Belyaev IY, Eriksson S, Nygren J, *et al.* Effects of ethidium bromide on DNA loop organisation in

- human lymphocytes measured by anomalous viscosity time dependence and single cell gel electrophoresis. *Biochim Biophys Acta* 1999; 1428: 348-56.
90. Ushakov VL, Alipov ED, Shcheglov VS, *et al.* Peculiarities of non-thermal effects of microwaves in the frequency range of 51-52 GHz on *E. coli* cells. *Radiats Biol Radioecol* 2006; 46: 719-28.
 91. Alipov YD, Belyaev IY, Kravchenko VG, *et al.* Experimental justification for generality of resonant response of prokaryotic and eukaryotic cells to MM waves of super-low intensity. *Physics of the Alive* 1993; 1: 72-80.
 92. Belyaev IY, Alipov YD, Polunin VA, *et al.* Evidence for dependence of resonant frequency of millimeter wave interaction with *Escherichia coli* K12 cells on haploid genome length. *Electro- and Magnetobiology* 1993; 12: 39-49.
 93. Shckorbatov YG, Pasiuga VN, Kolchigin NN, *et al.* The influence of differently polarised microwave radiation on chromatin in human cells. *Int J Radiat Biol* 2009; 85: 322-9.
 94. Binhi VN, Alipov YD, Belyaev IY. Effect of static magnetic field on *E. coli* cells and individual rotations of ion-protein complexes. *Bioelectromagnetics* 2001; 22: 79-86.
 95. Belyaev IY, Alipov ED, Harms-Ringdahl M. Effects of weak ELF on *E. coli* cells and human lymphocytes: role of genetic, physiological and physical parameters. In: Bersani F, ed. *Electricity and Magnetism in Biology and Medicine*. NY: Kluwer Academic, 1999, 481-4.
 96. Belyaev IY, Alipov ED. Frequency-dependent effects of ELF magnetic field on chromatin conformation in *Escherichia coli* cells and human lymphocytes. *Biochim Biophys Acta* 2001; 1526: 269-76.
 97. Matronchik AY, Belyaev IY. Model of slow nonuniform rotation of the charged DNA domain for effects of microwaves, static and alternating magnetic fields on conformation of nucleoid in living cells. In: Pokorny J, ed. *Fröhlich Centenary International Symposium "Coherence and Electromagnetic Fields in Biological Systems (CEFBIOS-2005)"*: Institute of Radio Engineering and Electronics, Academy of Sciences of the Czech Republic. Prague, Czech Republic, 2005, 63-4.
 98. Binhi VN. *Magnetobiology: Underlying Physical Problems*. San Diego: Academic Press, 2002.
 99. Matronchik AI, Alipov ED, Belyaev II. A model of phase modulation of high frequency nucleoid oscillations in reactions of *E. coli* cells to weak static and low-frequency magnetic fields (in Russian). *Biofizika* 1996; 41: 642-9.
 100. Chiabrera A, Bianco B, Cauffman JJ, *et al.* Quantum dynamics of ions in molecular crevices under electromagnetic exposure. In: Brighton CT, Pollack SR, eds. *Electromagnetics in Medicine and Biology*. San Francisco: San Francisco Press, 1991, 21-6.
 101. Chiabrera A, Bianco B, Moggia E, *et al.* Zeeman-Stark modeling of the RF EMF interaction with ligand binding. *Bioelectromagnetics* 2000; 21: 312-24.
 102. Matronchik AY, Belyaev IY. Mechanism for combined action of microwaves and static magnetic field: slow non uniform rotation of charged nucleoid. *Electromagn Biol Med* 2008; 27: 340-54.
 103. Panagopoulos DJ, Karabarbounis A, Margaritis LH. Mechanism for action of electromagnetic fields on cells. *Biochem Biophys Res Commun* 2002; 298: 95-102.
 104. Di Carlo A, White N, Guo F, *et al.* Chronic electromagnetic field exposure decreases HSP70 levels and lowers cytoprotection. *J Cell Biochem* 2002; 84: 447-54.
 105. Lai H. Interaction of microwaves and a temporally incoherent magnetic field on spatial learning in the rat. *Physiology & behavior* 2004; 82: 785-9.
 106. Lai H, Singh NP. Interaction of microwaves and a temporally incoherent magnetic field on single and double DNA strand breaks in rat brain cells. *Electromagnetic Biology and Medicine* 2005; 24: 23-9.
 107. Yao K, Wu W, Yu Y, *et al.* Effect of superposed electromagnetic noise on DNA damage of lens epithelial cells induced by microwave radiation. *Invest Ophthalmol Vis Sci* 2008; 49: 2009-15.
 108. Gapeev AB, Iakushina VS, Chemeris N K, *et al.* Dependence of EHF EMF effects on the value of the static magnetic field. *Doklady Akademii nauk / [Rossiiskaia akademii nauk]* 1999; 369: 404-7.
 109. Belyaev IY. Biological effects of low dose ionizing radiation and weak electromagnetic fields. In Andreev SG, ed. *7th Workshop on Microdosimetry*. Suzdal: MIFI Publisher, 1993, 128-46.
 110. Alipov ED, Shcheglov VS, Sarimov RM, *et al.* Cell-density dependent effects of low-dose ionizing radiation on *E. coli* cells. *Radiats Biol Radioecol* 2003; 43: 167-71.
 111. Belyaev IY, Alipov YD, Matronchik AY. Cell density dependent response of *E. coli* cells to weak ELF magnetic fields. *Bioelectromagnetics* 1998; 19: 300-9.
 112. Belyaev IY, Alipov YD, Matronchik AY, *et al.* Cooperativity in *E. coli* cell response to resonance effect of weak extremely low frequency electromagnetic field. *Bioelectrochem Bioenerg* 1995; 37: 85-90.

113. Golant MB, Kuznetsov AP, Bozhanova TP. The mechanism of synchronizing yeast cell cultures with EHF-radiation (in Russian). *Biofizika* 1994; 39: 490-5.
114. Stagg RB, Thomas WJ, Jones RA, *et al.* DNA synthesis and cell proliferation in C6 glioma and primary glial cells exposed to a 836.55 MHz modulated radiofrequency field. *Bioelectromagnetics* 1997; 18: 230-6.
115. Repacholi MH, Basten A, GebSKI V, *et al.* Lymphomas in E mu-Pim1 transgenic mice exposed to pulsed 900 MHz electromagnetic fields. *Radiat Res* 1997; 147: 631-40.
116. Czyz J, Guan K, Zeng Q, *et al.* High frequency electromagnetic fields (GSM signals) affect gene expression levels in tumor suppressor p53-deficient embryonic stem cells. *Bioelectromagnetics* 2004; 25: 296-307.
117. Schwarz C, Kratochvil E, Pilger A, *et al.* Radiofrequency electromagnetic fields (UMTS, 1,950 MHz) induce genotoxic effects in vitro in human fibroblasts but not in lymphocytes. *Int Arch Occup Environ Health* 2008; 81: 755-67.
118. Hoyto A, Juutilainen J, Naarala J. Ornithine decarboxylase activity is affected in primary astrocytes but not in secondary cell lines exposed to 872 MHz RF radiation. *Int J Radiat Biol* 2007; 83: 367-74.
119. Nylund R, Leszczynski D. Mobile phone radiation causes changes in gene and protein expression in human endothelial cell lines and the response seems to be genome- and proteome-dependent. *Proteomics* 2006; 6: 4769-80.
120. Zhao TY, Zou SP, Knapp PE. Exposure to cell phone radiation up-regulates apoptosis genes in primary cultures of neurons and astrocytes. *Neurosci Lett* 2007; 412: 34-8.
121. Papageorgiou CC, Nanou ED, Tsiafakis VG, *et al.* Gender related differences on the EEG during a simulated mobile phone signal. *Neuroreport* 2004; 15: 2557-60.
122. Smythe JW, Costall B. Mobile phone use facilitates memory in male, but not female, subjects. *Neuroreport* 2003; 14: 243-6.
123. Nam KC, Kim SW, Kim SC, *et al.* Effects of RF exposure of teenagers and adults by CDMA cellular phones. *Bioelectromagnetics* 2006; 27: 509-14.
124. Hardell L, Mild KH, Carlberg M, *et al.* Cellular and cordless telephone use and the association with brain tumors in different age groups. *Arch Environ Health* 2004; 59: 132-7.
125. Hardell L, Carlberg M. Mobile phones, cordless phones and the risk for brain tumours. *Int J Oncol* 2009; 35: 5-17.
126. Hardell L, Carlberg M, Hansson Mild K. Epidemiological evidence for an association between use of wireless phones and tumor diseases. *Pathophysiology* 2009; 16 (2-3): 113-22.
127. Shckorbatov YG, Grigoryeva NN, Shakhbazov VG, *et al.* Microwave irradiation influences on the state of human cell nuclei. *Bioelectromagnetics* 1998; 19: 414-9.
128. Hinrikus H, Bachmann M, Lass J, *et al.* Effect of low frequency modulated microwave exposure on human EEG: individual sensitivity. *Bioelectromagnetics* 2008; 29: 527-38.
129. Zotti-Martelli L, Peccatori M, Maggini V, *et al.* Individual responsiveness to induction of micronuclei in human lymphocytes after exposure in vitro to 1800-MHz microwave radiation. *Mutat Res* 2005; 582: 42-52.
130. Sannino A, Sarti M, Reddy SB, *et al.* Induction of adaptive response in human blood lymphocytes exposed to radiofrequency radiation. *Radiat Res* 2009; 171: 735-42.
131. Lai H, Singh NP. Single- and double-strand DNA breaks in rat brain cells after acute exposure to radiofrequency electromagnetic radiation. *Int J Radiat Biol* 1996; 69: 513-21.
132. Lai H, Singh NP. Melatonin and a spin-trap compound block radiofrequency electromagnetic radiation-induced DNA strand breaks in rat brain cells. *Bioelectromagnetics* 1997; 18: 446-54.
133. Oktem F, Ozguner F, Mollaoglu H, *et al.* Oxidative damage in the kidney induced by 900-MHz-emitted mobile phone: protection by melatonin. *Arch Med Res* 2005; 36: 350-5.
134. Ozguner F, Aydin G, Mollaoglu H, *et al.* Prevention of mobile phone induced skin tissue changes by melatonin in rat: an experimental study. *Toxicol Ind Health* 2004; 20: 133-9.
135. Ozguner F, Oktem F, Armagan A, *et al.* Comparative analysis of the protective effects of melatonin and caffeic acid phenethyl ester (CAPE) on mobile phone-induced renal impairment in rat. *Mol Cell Biochem* 2005; 276: 31-7.
136. Ozguner F, Oktem F, Ayata A, *et al.* A novel antioxidant agent caffeic acid phenethyl ester prevents long-term mobile phone exposure-induced renal impairment in rat. Prognostic value of malondialdehyde, N-acetyl-beta-D-glucosaminidase and nitric oxide determination. *Mol Cell Biochem* 2005; 277: 73-80.

137. Ozguner F, Altinbas A, Ozaydin M, *et al.* Mobile phone-induced myocardial oxidative stress: protection by a novel antioxidant agent caffeic acid phenethyl ester. *Toxicol Ind Health* 2005; 21: 223-30.
138. Ozguner F, Bardak Y, Comlekci S. Protective effects of melatonin and caffeic acid phenethyl ester against retinal oxidative stress in long-term use of mobile phone: a comparative study. *Mol Cell Biochem* 2006; 282: 83-8.
139. Ayata A, Mollaoglu H, Yilmaz HR, *et al.* Oxidative stress-mediated skin damage in an experimental mobile phone model can be prevented by melatonin. *J Dermatol* 2004; 31: 878-83.
140. Ilhan A, Gurel A, Armutcu F, *et al.* Ginkgo biloba prevents mobile phone-induced oxidative stress in rat brain. *Clin Chim Acta* 2004; 340: 153-62.
141. Koylu H, Mollaoglu H, Ozguner F, *et al.* Melatonin modulates 900 Mhz microwave-induced lipid peroxidation changes in rat brain. *Toxicol Ind Health* 2006; 22: 211-6.
142. Sokolovic D, Djindjic B, Nikolic J, *et al.* Melatonin reduces oxidative stress induced by chronic exposure of microwave radiation from mobile phones in rat brain. *J Radiat Res (Tokio)* 2008; 49(6): 579-86.
143. Sevast'yanova LA. Specific influence of millimeter waves on biological objects. In: Devyatkov ND, ed. *Nonthermal effects of millimeter waves radiation (in Russian)*. Moscow: Institute of Radioelectronics of USSR Academy of Science, 1981: 86-109.
144. Gos P, Eicher B, Kohli J, *et al.* Extremely high frequency electromagnetic fields at low power density do not affect the division of exponential phase *Saccharomyces cerevisiae* cells. *Bioelectromagnetics* 1997; 18: 142-55.
145. Fröhlich H. Long-range coherence and energy storage in biological systems. *Int J Quantum Chem* 1968; 2: 641-52.
146. Kaiser F. Coherent oscillations - their role in the interaction of weak ELM-fields with cellular systems. *Neural Network World* 1995; 5: 751-62.
147. Scott A. *Nonlinear science: emergence and dynamics of coherent structures*. Oxford: Oxford University Press, 1999.
148. Bischof M. Introduction to integrative biophysics. In: Popp FA, Belousov LV, eds. *Integrative biophysics*. Dordrecht: Kluwer Academic Publishers, 2003, 1-115.
149. Arinichev AD, Belyaev IY, Samedov VV, *et al.* The physical model of determining the electromagnetic characteristic frequencies of living cells by DNA structure. In: 2nd International Scientific Meeting "Microwaves in Medicine". Rome, Italy: "La Sapienza" University of Rome, 1993, 305-7.
150. Hardell L, Hansson Mild K. Mobile phone use and acoustic neuromas. *Epidemiology* 2005; 16: 415; author reply 7-8.
151. Hardell L, Hansson Mild K, Carlberg M. Further aspects on cellular and cordless telephones and brain tumours. *Int J Oncol* 2003; 22: 399-407.
152. Hardell L, Hansson Mild K, Pahlson A, *et al.* Ionizing radiation, cellular telephones and the risk for brain tumours. *Eur J Cancer Prev* 2001; 10: 523-9.
153. Ahlbom A, Green A, Kheifets L, *et al.* Swerdlow. Epidemiology of health effects of radiofrequency exposure. *Environ Health Perspect* 2004; 112: 1741-54.
154. Pacini S, Ruggiero M, Sardi I, *et al.* Exposure to global system for mobile communication (GSM) cellular phone radiofrequency alters gene expression, proliferation, and morphology of human skin fibroblasts. *Oncol Res* 2002; 13: 19-24.
155. Nikolova T, Czyn J, Rolletschek A, *et al.* Electromagnetic fields affect transcript levels of apoptosis-related genes in embryonic stem cell-derived neural progenitor cells. *Faseb J* 2005; 19(12): 1686-8.
156. Ozguner M, Koyu A, Cesur G, *et al.* Biological and morphological effects on the reproductive organ of rats after exposure to electromagnetic field. *Saudi Med J* 2005; 26: 405-10.
157. Panagopoulos DJ, Karabarbounis A, Margaritis LH. Effect of GSM 900-MHz mobile phone radiation on the reproductive capacity of *Drosophila melanogaster*. *Electromagnetic Biology and Medicine* 2004; 23: 29 - 43.
158. Fejes I, Za Vaczki Z, Szollosi J, *et al.* Is there a relationship between cell phone use and semen quality? *Arch Androl* 2005; 51: 385-93.
159. Aitken RJ, Bennetts LE, Sawyer D, *et al.* Impact of radio frequency electromagnetic radiation on DNA integrity in the male germline. *Int J Androl* 2005; 28: 171-9.

Mega-experiments on the carcinogenicity of Extremely Low Frequency Magnetic Fields (ELFMF) on Sprague-Dawley rats exposed from fetal life until spontaneous death: plan of the project and early results on mammary carcinogenesis

Morando Soffritti*, Fiorella Belpoggi*, Michelina Lauriola*, Eva Tibaldi*, Fabiana Manservigi*, Damiano Accurso*, Daniela Chiozzotto*, Livio Giuliani**

* Cesare Maltoni Cancer Research Center, Ramazzini Institute, Bologna, Italy

** National Institute for Prevention and Safety at Work (ISPESL), Rome, Italy

Abstract

In 2002 Ramazzini Institute lunched an experimental research project to evaluate the potential carcinogenic effects of power frequency magnetic fields in Sprague-Dawley rats exposed from prenatal life until spontaneous death to sinusoidal 50 Hz-magnetic fields (S-50Hz MF) at various intensity levels, or in association with other agents. For this objective, 4 experiments were planned as an integrated experimental project aiming to: 1) assess the qualitative- quantitative potential carcinogenic effects on S-50Hz MF in various different exposure situations, with reference to intensity and continuity/discontinuity of the electric current; 2) evaluate the effects on reproductivity and embryo/fetus toxicity of S-50Hz MF; 3) assess the syncarcinogenic effects of S-50Hz MF and other electromagnetic fields (γ -radiation); 4) assess the syncarcinogenic effects of S-50Hz MF and carcinogenic chemical agents such as formaldehyde and Aflatoxin B1; 5) evaluate, by molecular biology analysis, the possible pathogenic mechanisms at the basis of carcinogenesis. In the research project are included the evaluation of 2,100 breeders and 7,133 offspring. In the present report will be illustrate the design of the global project and the first result concerning the carcinogenic effects to the mammary gland in females exposed to S-50Hz MF from fetal life until death as well as to 10 rads γ -radiation delivered in one shot at 6 weeks of age.

***Key words:* Extremely Low Frequency Magnetic Fields (ELFMF), γ -radiation, syncarcinogenicity, Sprague-Dawley rats, long-term bioassay, prenatal life-span exposure, breast cancer.**

Introduction

In the seventies, Wertheimer and Leeper, epidemiologists from the Colorado Medical Center University, were requested by the administrators of the City of Denver, to inves-

Address: Morando Soffritti, M.D., Scientific Director of the Ramazzini Institute, Cesare Maltoni Cancer Research Center, Via Saliceto, 3, 40010 Bentivoglio, Bologna, Italy
Tel. +39 051 6640460 - Fax +39 051 6640223 - E-mail: credir@ramazzini.it

tigate the possible causes of childhood cancers in Denver. They reviewed several possible causes of childhood cancers known at that time, such as ionizing radiation, atmospheric pollution related to the density of automobile traffic, the mother's job and the type of drug assumption during pregnancy, etc. None of the factors or situation of carcinogenic risk considered showed any significant difference between cases and controls. It was when interviewing the family in the residences of children with cancers that Wertheimer and Leeper observed the frequent presence of power lines and transformers. Surprisingly, they found a significant difference in the incidence of leukemia among children living near power lines compared to children living in residences not exposed to such electromagnetic fields (EMF). They also observed that the risk increased at the EMF intensity of $>0.2 \mu\text{T}$.

Since 1979, when the results of Wertheimer and Leeper's epidemiological study were published¹, other epidemiological research carried out in many countries on children resident in houses in the proximity of electricity power lines has confirmed the potential carcinogenic risk from electricity-generated EMF. The epidemiology on EMF and childhood leukemia is summarized in a pooled analysis of measurement and calculated field studies published by Ahlbom *et al*². The study concludes that relative risk (with a 95% CI) was 2.0 (range 1.2 – 3.1) when the exposure is $\geq 0.4 \mu\text{T}$.

This association between childhood leukemias and power line EMF exposure in case-control studies and population studies was not considered sufficient to establish a cause-correlation for two reasons: 1) absence of a plausible mechanism; and 2) lack of support from laboratory evidence, in particular adequate long-term carcinogenicity bioassays. These factors led the IARC to classify EMF power frequency as a possible carcinogenic agent on the basis of limited epidemiological evidence and inadequate evidence in experimental long-term rodent bioassays³.

Because epidemiological studies were inconclusive, in the early '90s long-term carcinogenicity bioassays on rats and mice were performed in order to evaluate the biological effect and the potential hazard of the interaction with low frequency magnetic fields. The reason why research on magnetic fields (MF) attracted particular attention for potential adverse health effects was because electric fields (EF) may easily be shielded while MF are not.

Up to now, long-term carcinogenicity bioassays on extremely low-frequency magnetic fields (ELFMF) have been conducted in Canada, Japan and the United States (US). The results of the studies, summarized in Table 1, failed to show carcinogenic effects in the experimental conditions.

Indeed, the studies performed in Canada and Japan cannot be considered adequate to expose the carcinogenicity of the ELFMF because of the poor experimental design: only one sex (male) and short duration of the experiments^{4,5}; small groups of male and female rats exposed for 104 weeks⁶.

The most comprehensive study to date on ELFMF as a potential carcinogen was the one conducted in the US by the National Toxicology Program (NTP). The results of that study have been reported in the scientific literature^{7,8}. In the NTP study, which was conducted following Good Laboratory Practices (GLP), groups of 100 Fischer 344 rats and 100 B6C3F1 mice of either sex were exposed to one of several magnetic field conditions: 2; 200; or 1000 μT continuously or 1000 μT intermittently (1 h on/1 h off), 60 Hz linearly polarized MF; one group received sham exposure. Exposure began when the animals were 6-7 weeks of age and continued for 18.5 hr/day over a period of two years. After two years of exposure, the animals still alive were sacrificed. The report conclud-

Table 1 - Power frequency EMF: experimental evidence

Authors	Animals		Treatment		Results	Comments
	Species/ strain	No	Exposure	Duration		
Margonato <i>et al.</i> , 1995 ⁴	Rats S.D.	256 males per group	0; 5 μ T (50 Hz)	32 weeks (22 hr/day)	No evidence of carcinogenic effect	Only 1 sex (male); short duration (32 weeks)
Yasui <i>et al.</i> , 1997 ⁵	Rats F344	48 females per group	0; 0,5; 5 μ T (50 Hz)	2 years (22 hr/day)	No evidence of carcinogenic effect	Only 1 sex (female); short duration (104 weeks)
Mandeville <i>et al.</i> , 1997 ⁶	Rats F344	50 males and 50 females per group	0; 2; 20; 200; 2000 μ T (60 Hz)	2 years, GLP (20 hr/day)	No evidence of carcinogenic effect	Few animals; short duration (104 weeks)
NTP, 1998 ^{7,8}	Rats F344 Mice B6C3F1	100 males and 100 females per species and per group	0; 2; 200; 1000 μ T	2 years, GLP (18.5 hr/day)	Equivocal evidence of carcinogenic effect for thyroid C cell tumour in male treated with 2 or 200 μ T	Short duration (104 weeks)

ed that there was equivocal evidence for the carcinogenic activity of 60 Hz MF in Fischer 344 rats on the basis of the increased incidence of thyroid gland C-cell neoplasms in males exposed to 2 or 200 μ T. There was no evidence of carcinogenicity in female rats or in male and female mice.

While on the basis of the epidemiological evidence 60 Hz ELFEMF must be considered a possible low potency carcinogenic agent, the plan and conduct of the NTP study present some limitations for the following reasons at least: 1) to expose the carcinogenic effects of low potency carcinogens, experimental bioassays need large groups of animals (mega-experiments) of the type which have been conducted in our laboratories in some instances; 2) the number of animals per group in the NTP experiment may well be insufficient to expose the effects of a low potency carcinogen; 3) the limitation is aggravated by the fact that the experiments were started at 6 weeks of age instead of fetal life and moreover were truncated after 104 weeks, when the majority of animals were still alive (male rats 259/500; female rats 301/500; male mice 367/500; female mice 373/500), thus not enabling them to reach the critical age for developing their neoplastic potentialities. Had we truncated our experiments on vinyl chloride after two years, we would never have exposed the carcinogenic effects of the compound at low doses, and the consequent introduction of the present regulations would not have taken place.

In this scenario the experimental project on ELFEMF, planned for several years now by the Ramazzini Institute (RI), should be considered crucial for evaluating the carcinogenic potentiality of MF generated by electricity.

The RI experiments were planned as an integrated experimental project aiming to:

- 1) evaluate the effects of sinusoidal-50 Hz magnetic fields (S-50Hz MF) on reproductivity and embryo-foetus toxicity;
- 2) assess the qualitative-quantitative potential carcinogenic effects of sinusoidal S-50 Hz MF in various different exposure situations, with reference to intensity and continuity/discontinuity of the electric current. Should there be a positive result, the study aims to identify the target organs of the carcinogenic effects, the type of tumors observed and their precursors, and other pathological effects relevant to public health and scientific knowledge;
- 3) assess the syncarcinogenic risks of S-50Hz MF and other electromagnetic fields (γ -radiation);
- 4) assess the syncarcinogenic risks of S-50Hz MF and carcinogenic chemical agents such as formaldehyde and Aflatoxin B1;
- 5) evaluate, by molecular biology analysis, the possible pathogenic mechanisms at the basis of the carcinogenesis.

All the animals were exposed to a MF for 19 hr/day from fetal life until spontaneous death, and all the experiments in the project started simultaneously on July 2002. The global plan of the project is reported in Tables 2-5. The experimental project encompassed 4 mega-experiments including 2,100 breeders and 7,133 offspring.

Table 2 - Experiment BT 1CEM: experimental plan of the research on the long-term biological effects of sinusoidal -50 Hz magnetic fields (S-50Hz MF) administered alone or concurrently with other exposures, on male (M) and female (F) Sprague-Dawley rats^a

Experiment	Group	Basic treatment S-50Hz MF(μ T) ^b	Other exposure	Animals			Duration of the exposure to MF	Effects of the S-50 Hz MF to verify
				M	F	M+F		
BT 1CEM	I	1000 C	-	253	270	523	LS	Carcinogenic and toxic effects (as end-point)
	II	1000 O/O	-	250	250	500	LS	Carcinogenic and toxic effects (as end-point)
	III	100 C	-	500	500	1000	LS	Carcinogenic and toxic effects (as end-point)
	IV	20 C	-	501	502	1003	LS	Carcinogenic and toxic effects (as end-point)
	V	2 C	-	500	502	1002	LS	Carcinogenic and toxic effects (as end-point)
	VI	0 (control) ^c	-	500	501	1001	LS	-
Total				2504	2525	5029		

^a Exposure of the animals of the experiment starts from the 12th day of the fetal life, by irradiation of pregnant breeders

^b The treatment with S-50 Hz MF lasts for the whole natural life (Life span = LS), for 19 hr/day, continuously (C) or intermittently On/Off (O/O)

^c The control group is shared with experiments BT 2CEM and BT 3CEM

Table 3 - Experiment BT 2CEM: experimental plan of the research on the long-term biological effects of sinusoidal -50 Hz magnetic fields (S-50Hz MF) administered alone or concurrently with other exposure, on male (M) and female (F) Sprague-Dawley rats^a

Experiment	Group	Basic treatment S-50Hz MF(μ T) ^b	Other exposure	Animals			Duration of the exposure to MF	Effects of the S-50 Hz MF to verify
				M	F	M+F		
BT 2 CEM	I	1000 C	Formaldehyde 50 mg/l ^c	200	203	403	LS	Sinergistic carcinogenic effects (as end-point)
	II	0	Formaldehyde 50 mg/l ^c	200	202	402	LS	Carcinogenic effects (as end-point)
	III	0 (control) ^d	-	500	501	1001	LS	-
	Total			900	906	1806		

^a Exposure of the animals of the experiment starts from the 12th day of the fetal life, by irradiation of pregnant breeders

^b The basic treatment with S-50Hz MF lasts for the whole natural life (Life span = LS), for 19 hr/day, continuously (C)

^c Administered with drinking water supplied *ad libitum*, starting from 6 weeks of age and lasting 104 weeks

^d The control group is shared with experiments BT 1CEM and BT 3CEM

The project was reviewed and validated by an international scientific committee appointed by the Regional Agency for Prevention and the Environment in Emilia-Romagna, Italy.

The biophase ended in June 2005.

This report presents the first results of the experiment designed to assess the potential syncarcinogenic risks of exposure to S-50Hz MF and to low-dose γ -radiation.

Assessment of the syncarcinogenic effects of S-50Hz MF and low dose γ -radiation exposure (EXP. BT 3CEM): first results on mammary cancer

This bioassay was planned to reproduce experimentally a very common human scenario in which life-span exposure to 50-60 Hz MF may be associated with an exposure to a low dose of ionizing radiation such as comes from medical sources, nuclear power production, occupational exposure, etc.

Reported here are the results in terms of the carcinogenic effects on the mammary gland of female Sprague-Dawley rats exposed both to S-50Hz MF from fetal life until spontaneous death and to low-dose one-off γ -radiation (10 rads) delivered at 6 weeks of age as an initiating treatment.

Materials and methods

A) S-50Hz MF exposure system

In order to give all the experimental groups the same environment conditions (i.e. a temperature of 22°C, a relative humidity of 40-60% and a 12 hr/day homogeneous diffusion of light) the rats were located in a room of 60x15x4 m (over 900 m²) (fig. 1).

Table 4 - Experiment BT 3CEM: experimental plan of the research on the long-term biological effects of sinusoidal -50 Hz magnetic fields (S-50Hz MF) administered alone or concurrently with other exposure, on male (M) and female (F) Sprague-Dawley rats^a

Experiment	Group	Basic treatment S-50Hz MF(μ T) ^b	Other exposure	Animals			Duration of the exposure to MF	Effects of the S-50 Hz MF to verify
				M	F	M+F		
BT 3 CEM	I	1000 C	γ -radiation 10 rad ^c	110	112	222	LS	Sinergistic carcinogenic effects (as end-point)
	II	20 C	γ -radiation 10 rad ^c	105	107	212	LS	Sinergistic carcinogenic effects (as end-point)
	III	1000 C ^d	–	253	270	523	LS	Carcinogenic effects (as end-point)
	IV	0	γ -radiation 10 rad ^c	118	105	223	LS	Carcinogenic effects (as end-point)
	V	0 (control) ^e	–	500	501	1001	LS	–
Total				1086	1095	2181		

^a Exposure of the animals of the experiment starts from the 12th day of the fetal life, by irradiation of pregnant breeders

^b The basic treatment with S-50Hz MF lasts for the whole natural life (Life span = LS), for 19 hr/day, continuously (C)

^c As initiating treatment, treated one off (*una tantum*), at 6 weeks of age

^d The group exposed to 1000 μ T is shared with the experiment BT1CEM

^e The control group is shared with experiments BT 1CEM and BT 2CEM

The MF exposure system was constructed so as to satisfy a number of conditions, namely: 1) the MF must be linearly polarised; 2) the field uniformity must be better than $\pm 10\%$; 3) the field lines must be horizontal and parallel to the ground; 4) the supply current must have a maximum harmonic distortion of 3%; 5) the field rise time at power up must be at least 10 periods (for 50Hz, 200 ms); 6) the current generator must be noiseless; 7) the joule effect on windings must not alter the environmental temperature, a maximum variation of 2°C being tolerated near coils; 8) coil noise and vibration is to be eliminated; 9) the natural field level must be no more than 0.1 μ T and any mutual interaction of the system must be avoided, furthermore the control group should preferably stay in the same room.

The most stringent constraint is the last one which in fact conditions the possible choices very strongly. The other requirements can easily be complied with, using proper technical selection.

The exposure system is based on independent devices. Each simple exposure device serves at least 500 rats leaving enough space to isolate ill/moribund rats.

In order to satisfy the stray field requirements, a good solution was obtained by using a toroidal-shaped device. Fig. 2 shows the device's magnetic structure. All the devices needed are identical and the different intensity of MF is obtained by properly tuning the power supplies which are of the current- controlled type.

Table 5 - Experiment BT 4CEM: experimental plan of the research on the long-term biological effects of sinusoidal -50 Hz magnetic fields (S-50Hz MF) administered alone or with other exposure, on male (M) and female (F) Sprague-Dawley rats ^a

Experiment	Group	Basic treatment S-50Hz MF(μ T) ^b	Other exposure	Animals			Duration of the exposure to MF	Effects of the S-50 Hz MF to verify
				M	F	M+F		
BT 4 CEM	I	1000 C	Aflatoxin B1 ^c	102	120	222	Depending the interim on sacrifice schedule	Capacity of enhancing the formation of preneoplastic hepatic foci (as early markers of carcinogenic risk)
	II	0	Aflatoxin B1 ^c	103	102	205		
	III	0 (control) ^d	-	112	103	215		
	Total	317		325		642		

^a Exposure of the animals of the experiments BT 1-4CEM starts from the 12th day of fetal life, by irradiation of pregnant breeders

^b The duration of the basic treatment with S-50Hz MF depends on the interim sacrifice schedule, is lasting for 19 hr/day, continuously (C)

^c As initiating treatment, dissolved in dimethylsulfoxide (DMSO), administered 5 times and 4 times respectively at the 6th and the 7th week of age; 10 males and 10 females are sacrificed after 2, 6, 10, 14, 22, 32, 42, 52 weeks after the end of the treatment with AFB1, and then all animals still alive after 72 weeks

^d DMSO, 1cc, by gavage



Fig. 1. Exposure system and the room where was conducted the biophase of the experiments

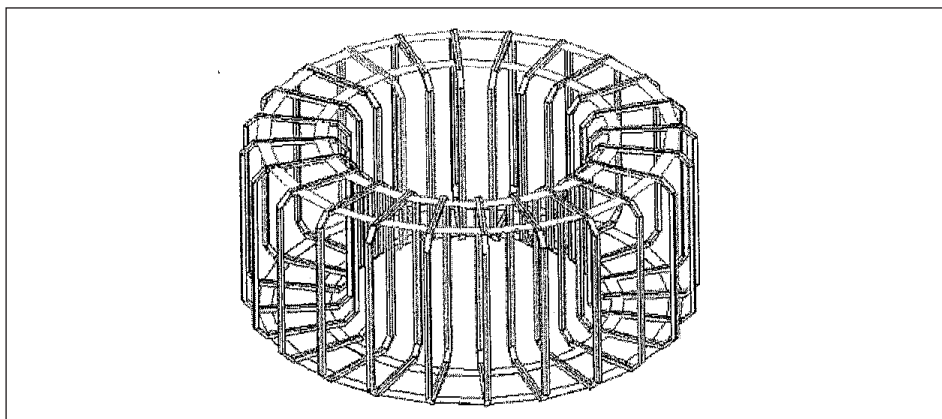

Fig. 2. The toroidal shaped magnetic device

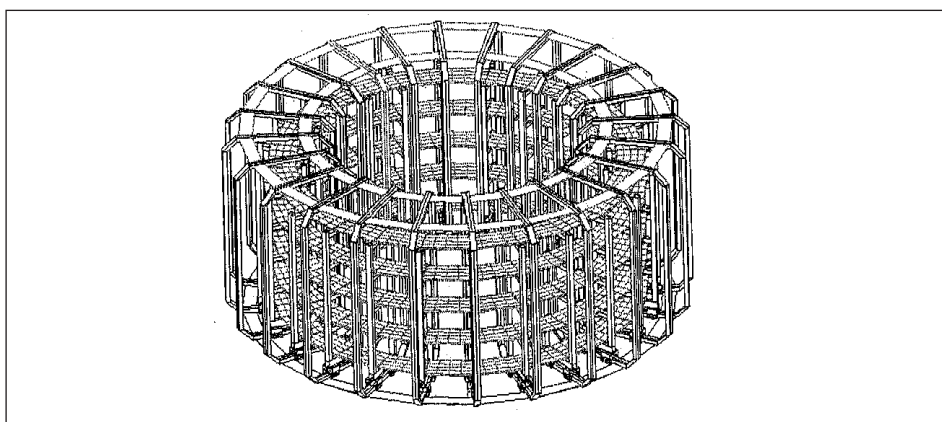

Fig. 3. Wood support structure mounted inside the toroidal magnet for allocation of rat cages

The toroid was designed with 24 coils made of three turns of insulated copper cable, mounted on a superstructure of aluminium composed of two insulated parts in order to avoid a closed loop subject to total field. The total copper cross section is $11 \times 28 \text{ mm}^2$, and the total current used for 1 mT level is 359.6 A. The electric power is supplied by low current density and the large amount of a good thermal-conducting prevents heating, leaving the device at room temperature. Vibrations and noise are proven to be absent.

Mounted inside the toroidal magnet is a wooden support structure for rat cages (fig. 3). One of the toroids to be used was mounted and treated in order to verify the correctness of the computed parameters pertaining to the experiment. All the results were in agreement with the computed values.

A magnetic field probe was placed at a representative animal location to monitor the fields.

The details of the exposure system have been described elsewhere⁹. The apparatus was also evaluated by a representative of the USA National Institute of Standards and Technology (NIST).

B) Gamma radiation exposure system

The radiation source was a therapy unit supplying Co60. Dose measurement was made using a Nuclear Enterprise dosimeter type 2571A, with a 0.6 cc graphite ionization chamber, calibrated in terms of dose absorbed to water with a 4% uncertainty.

Treatment at the required one off dose of 10 rads was divided into two equal irradiations, performed on the ventral and dorsal side of the animals respectively. In this way the rats were treated by 2 opposite irradiation fields, with an almost homogeneous dose distribution.

C) Experimental animals

The animals used are Sprague-Dawley rats from the same colony used for more than 35 years at the CMCRC of the RI. The basic expected tumorigram and its fluctuations are based upon data derived from more than 18.000 historical controls. For the specific purposes of this report, it must be stressed that in female Sprague-Dawley rats mammary tumors are the most frequent and an excellent example of a human equivalent animal model¹⁰⁻¹². All types of mammary tumors, and in particular all histotypes and subhistotypes of mammary carcinomas, observed in human pathology, have also been found in untreated female Sprague-Dawley rats. Among the historical controls over the last 10 years the overall incidence of mammary carcinomas in female Sprague-Dawley rats was 8.9% with a range of fluctuation of 2.9-14.1%. The equivalent age distribution of mammary carcinomas is very similar to those observed in women in industrialized countries¹³. Like the human counterpart, mammary carcinomas in female Sprague-Dawley rats give local and distant metastases¹³.

The rats in this experiment were born from strictly out-bred matching. Since female breeders were being treated, the animals in the experimental groups were predetermined. At 4-5 weeks of age (after weaning) they were identified by ear punch and distributed by sex and litter by litter, until the planned number for each group was reached. They were housed 5 per cage in polycarbonate cages (41x25x15 cm) with covers made of non-magnetic metal and a shallow layer of white wood shaving as bedding.

The experiment was conducted according to Italian law regulating the use and human treatment of animals for scientific purposes¹⁴.

D) Treatment

Treatment with S-50Hz MF began during fetal life exposing the female breeders from the 12th day of pregnancy. The breeders were sacrificed after weaning while treatment of offsprings lasted until natural death. The daily exposure to S-50Hz MF for both breeders and offsprings was 19 hours. The animals of groups I and II were also treated with 10 rads of gamma radiations one-off at 6 weeks of age. The animals in group III were exposed to MF alone. The animals in group IV were exposed to only one shot of 10 rads γ -radiation. The controls were kept in the same environmental conditions. The plan of experiment BT 3CEM is reported in Table 4.

E) Conduct of the experiment

All animals were kept in highly standardized environmental and diet conditions, the same as used in our laboratories. The daily feed and water consumption were measured in a sample of 100 animals (50 males and 50 females) from each group from the age of 6 weeks, every 2 weeks, for the first 8 weeks, and then at 4 week intervals, until 110 weeks of age. Body weight was recorded from the age of 6 weeks, every 2 weeks for the first 8 weeks, every 4 weeks until 110 weeks of age, and then every 8 weeks until the end of the experiment. Animal health and behaviour were checked 3 times daily throughout the experiment. Checking for pathological lesions, including mammary tumors, was performed every 2 weeks for the first 8 weeks and every 4 weeks until the end of the experiment.

From all dead animals, in addition to macroscopically observed pathological lesions (with a margin of normal tissue), the following tissues and organs were taken: skin, subcutaneous tissue, mammary gland (two pairs, axillaries and inguinal), brain, pituitary gland, Zymbal gland, ear duct, salivary gland, Harderian gland, cranium (nasal and oral cavities: 5 levels), tongue, thyroid and parathyroid glands, pharynx, larynx, thymus, trachea, lung, heart, diaphragm, liver, spleen, pancreas, kidney, adrenal gland, esophagus, stomach, intestine (4 levels), bladder, prostate, uterus, gonads, vagina, interscapular fat pad, subcutaneous, mediastinal and mesenteric lymphnodes. All specimens were fixed in 70% alcohol, except for bones and other tissues with osseous consistency which are fixed in 10% formalin. All pathological tissues were trimmed in order to include a portion of adjacent normal tissue. As far as normal tissues and organs are concerned, the trimming was performed according to standard laboratory procedures. The trimmed specimens were processed and embedded in paraffin blocks according to standard procedures. 3-6 μm sections were performed and routinely stained with haematoxylin eosin. Histopathology evaluation were performed by the same group of pathologists.

Statistical analyses of the incidence of fibroadenomas and mammary cancers were based on Logistic analysis and on the Cox proportional hazard model, respectively.

The biophase ended on June 30th 2005 with the death of the last animal at the age of 153 weeks.

First results on mammary carcinogenesis

This report gives results concerning carcinogenic effects to the mammary gland in female Sprague-Dawley rats exposed to S-50Hz MF from fetal life until death as well as to 10 rads γ -radiation delivered in one shot at 6 weeks of age.

The experiment ran smoothly without unexpected setbacks. Concerning the mean daily feed and water consumption and mean body weight, no relevant differences were observed among the females of the various groups.

No substantial differences were observed in survival among the females of the various groups (fig. 4).

During the biophase the development of mammary lumps was monitored by palpation, every 4 weeks until the spontaneous death of the animals. The cumulative prevalence of mammary lumps clinically observed at the age of insurgency is reported in fig. 5. It is clear that the exposure to both MF and γ -radiation increases the incidence of mammary lumps and also accelerates the onset of such lesions when compared to ani-

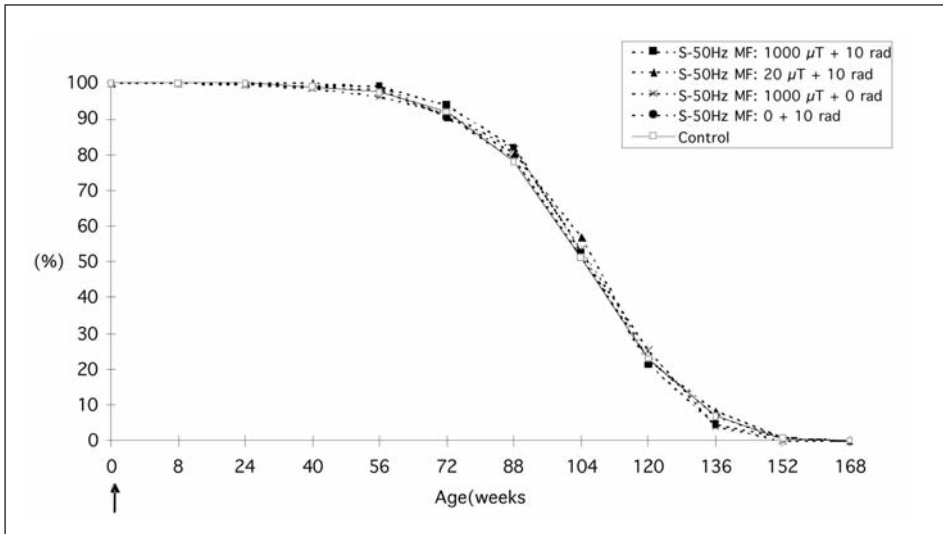

Fig. 4. Survival in female Sprague-Dawley rats (arrow indicates the start of the experiment) (Exp. BT3 CEM)

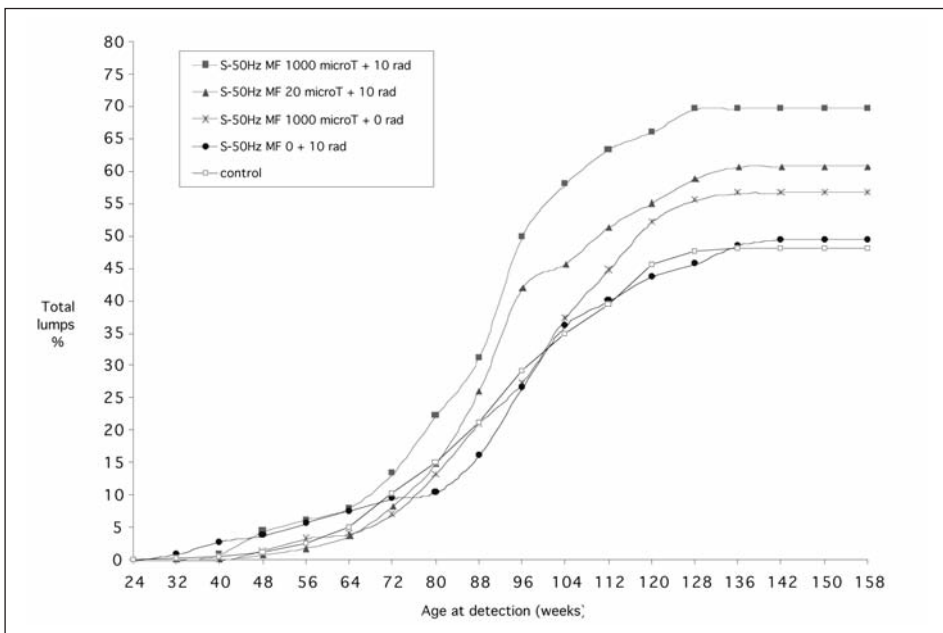

Fig. 5. Cumulative prevalence of glandular mammary lumps in female Sprague-Dawley rats clinically observed at the age of insurgency (Exp. BT 3CEM)

mals exposed to only 10 rads or only 1000 μ T MF or not exposed (negative control group). Not all lumps palpated are confirmed as being mammary gland lesions, and small lesions may have been missed during clinical patrols.

At necropsy all grossly mammary tumors and the axillary and inguinal mammary gland tissues of each animal were collected and histopathologically evaluated. The incidences of fibroadenomas and carcinomas of the mammary gland are respectively reported in Tables 6, 7 and the cumulative prevalence in figs. 6 and 7.

An increased incidence (albeit not significant) of animals bearing fibroadenomas was observed in females exposed to 1000 μ T plus 10 rads as compared to the other groups

Table 6 - Experiment BT 3CEM: experimental study on the long-term syncarcinogenetic effects of sinusoidal - 50Hz magnetic fields (S-50Hz MF) and γ -radiation on male (M) and female (F) Sprague-Dawley rats. Results: benign fibroadenomas histopathologically evaluated in females

Group	Animals		Treatment		Mammary fibroadenomas			
	Sex	No.	S-50Hz MF (μ T) ^a	γ -radiation (rad) ^b	Bearing animals		Total tumours	
					No.	%	No.	Per 100 animals
I	F	112	1000	10	51	45,5	77	68,8
II	F	107	20	10	51	47,7	64	59,8
III ^c	F	270	1000	-	118	43,7	164	60,7
IV	F	105	0	10	43	41,0	55	52,4
V ^c	F	501	0	-	207	41,3	268	53,5
			(control)					

^a The treatment 19 hr/day started at 12th day of fetal life, with the irradiation of breeders and lasted until spontaneous death.

^b γ -radiations were administered one off at 6 weeks of age.

^c Group in common with the experiment BT 1 CEM.

Table 7 - Experiment BT 3CEM: experimental study on the long-term syncarcinogenetic effects of sinusoidal - 50Hz magnetic fields (S-50Hz MF) and γ -radiation on male (M) and female (F) Sprague-Dawley rats. Results: mammary cancers in female

Group	Animals		Treatment		Mammary fibroadenomas			
	Sex	No.	S-50Hz MF (μ T) ^a	γ -radiation (rad) ^b	Bearing animals		Total tumours	
					No.	%	No.	Per 100 animals
I	F	112	1000	10	18	16,1	19	17,0**
II	F	107	20	10	8	7,5	9	8,4
III ^c	F	270	1000	-	22	8,1	23	8,5
IV	F	105	0	10	8	7,6	8	7,6
V ^c	F	501	0	-	32	6,4	32	6,4
			(control)					

^a The treatment 19 hr/day started at 12th day of fetal life, with the irradiation of breeders and lasted until spontaneous death.

^b γ -radiations were administered one off at 6 weeks of age.

^c Group in common with the experiment BT 1 CEM.

** Significant ($p \leq 0.001$) using Cox regression model

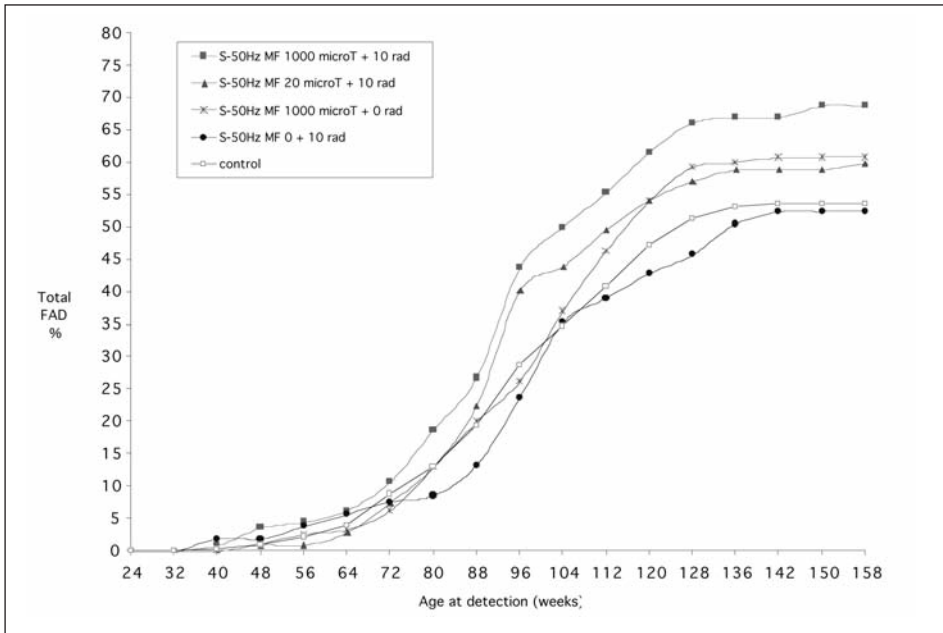

Fig. 6. Cumulative prevalence of glandular mammary fibroadenomas in female Sprague-Dawley rats clinically observed at the age of insurgency and histopathologically evaluated (Exp. BT 3CEM)

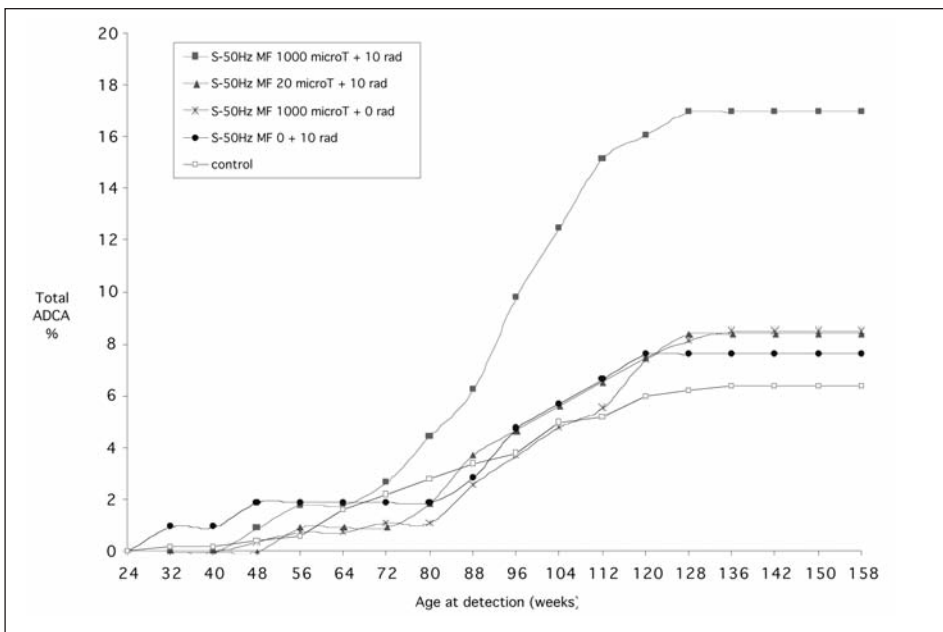

Fig. 7. Cumulative prevalence of glandular mammary adenocarcinomas in female Sprague-Dawley rats clinically observed at the age of insurgency histopathologically evaluated (Exp. BT 3CEM)

(Table 6). The cumulative prevalence (fig. 6) shows a slight anticipation of the onset of fibroadenomas clinically observed and histopathologically evaluated among the females exposed to 1000 μ T and 10 rads, again as compared to the other groups.

Exposure to 1000 μ T MF plus 10 rads caused a significant increase ($p < 0.001$) in adenocarcinomas compared to the negative control group. The additional 10 rads exposure in females exposed lifelong to 1000 μ T MF compared to females exposed only to 10 rads, caused a significant increase ($p < 0.04$) in the incidence of mammary adenocarcinomas. This is of some interest because in another life-span experiment performed by us, we saw no effects after exposure to 10 rads γ radiation^{15,16}. The cumulative prevalence (fig. 7) shows that the onset of mammary adenocarcinomas among females exposed to 1000 μ T MF and 10 rads was clearly earlier than in other groups.

Discussion

To our knowledge, the early results of this experimental study show for the first time that a life-span exposure (starting from prenatal life) to power frequency (50 Hz) MF, combined with exposure to a well-known carcinogenic agent, as is γ radiation, induce a significant increased risk of malignant tumors, namely mammary cancers, in female Sprague-Dawley rats, the strain of rat used in our laboratory for decades and for which data on mammary carcinogenesis are available on more than 18.000 historical controls.

The first data on the human risk of breast cancer related to exposure to power frequency MF were reported by Matanoski *et al.*¹⁷ in a study conducted among telephone company male workers in the US.

After this early warning, other studies confirmed the association of increased risk of breast cancers in women and men exposed to power frequency MF in the workplace or in the general environment. However, other similar studies do not show the same effects in both sexes.

Over the years, international agencies have reviewed the data on the relationship between exposure to MF and risk of breast cancer in men and women, reaching the same conclusion: the available evidence is inadequate for an evaluation of the risk^{3,18}. Since the IARC and NIEHS evaluations, several additional occupational studies, including a few studies of residential exposure and electric bed-heating devices have been published in literature, again without indicating any increased risk¹⁹.

Concurrently with epidemiological investigations, experimental studies on rodents have been performed to evaluate the possible cancer risk to the mammary gland associated with 50-60 Hz MF exposure using specific mammary cancer models. The results of the first study were reported by Beniashvili *et al.*²⁰ suggesting that 50 Hz MF enhanced the development of mammary cancer induced by N-methyl-N-nitrosourea (NMU). Other authors used the 7,12 -dimethylbenz(a)anthracene (DMBA) rat mammary tumor model to evaluate the potential effects 50-60 Hz MF exposure on breast cancer. Using this model, it was shown that 50 Hz MF enhances the mammary tumor development in response to DMBA²¹⁻²⁵. Other authors have failed in their attempt to replicate these findings²⁶⁻²⁹.

Conclusions

Our study may be considered representative of a situation of potential diffuse carcinogenic risk: exposure to a low dose of a well-known human carcinogenic risk (ionizing radiation) combined with exposure to a possible carcinogenic risk (power frequency MF). These first results on mammary carcinogenesis is urging to continue exploring the potential effects and mechanisms of power frequency MF in the carcinogenic process.

References

1. Wertheimer N, Leeper E. Electrical wiring configurations and childhood cancer. *Am J Epidemiol* 1979; 109: 273-84.
2. Ahlbom A, Day N, Feychting M, *et al.* A pooled analysis of magnetic fields and childhood leukaemia. *Br J Cancer* 2000; 83: 692-8.
3. International Agency for Research on Cancer (IARC). IARC Monographs on the evaluation of carcinogenic risks to humans. Vol. 80. Non-ionizing radiation, part: 1: static and extremely low-frequency (ELF) electric and magnetic fields. Lion: IARC, 2002; 1-395.
4. Margonato V, Nicolini P, Conti R, *et al.* Biologic effects of prolonged exposure to ELF electromagnetic fields in rats: II. 50 Hz magnetic fields. *Bioelectromagnetics* 1995; 16: 343-55.
5. Yasui M, Kikuchi T, Ogawa Y, *et al.* Carcinogenicity test of 50 Hz sinusoidal magnetic fields in rats. *Bioelectromagnetics* 1997; 18, 531-40.
6. Mandeville R, Franco E, Sidrac-Ghali, *et al.* Evaluation of the potential carcinogenicity of 60 Hz linear sinusoidal continuous-wave magnetic fields in Fisher F344 rats. *FASEB J* 1997; 11:1127-36.
7. Boorman GA, McCormick DL, Findlay JC, *et al.* Chronic toxicity/oncogenicity of 60 Hz (power frequency) magnetic field in F344/N rats. *Toxicol Pathol* 1999; 27(3): 267-78.
8. McCormick DL, Boorman GA, Findlay JC, *et al.* Chronic toxicity/oncogenicity of 60 Hz (power frequency) magnetic field in B6C3F1 mice. *Toxicol Pathol* 1999; 27(3): 279-85.
9. Montanari I. Optimal design of a system for large in vivo experiments on the effects of 50-Hz magnetic fields. *IEEE Trans on Mag* 2003; 39(3): 1823-6.
10. Maltoni C, Minardi F, Soffritti M. Chemoprevention of experimental mammary cancer by tamoxifen. In De Palo G, Sporn M, Veronesi U. *Progress and Perspectives in chemoprevention of cancer*, Raven Press, 1992; 79: 23-45.
11. Soffritti M, Belpoggi F, Minardi F, *et al.* Chemopreventive effects of Vitamin A (Retinyl acetate and palmitate) and N-(4-Hydroxyphenyl) Retinamide in rats, with reference to mammary carcinoma. In De Palo G, Sporn M, Veronesi U. *Progress and Perspectives in chemoprevention of cancer*, Raven Press, 1992; 79: 47-60.
12. Maltoni C, Minardi F, Pinto C, *et al.* Results of three life span experimental carcinogenicity studies on tamoxifen in rats. In Bingham E, Rall DP. *Preventive strategies for living in a chemical world*. *Ann N Y Acad Sci.* 1997; 837: 469-512.
13. Maltoni C. Il contributo della cancerogenesi sperimentale alla conoscenza degli agenti causali, della storia naturale e del controllo della crescita del carcinoma mammario. *Acta Oncologica*, 1982; 3: 97-112.
14. Decreto Legislativo 116. 1992. Attuazione della direttiva n. 86/609/CEE in materia di protezione degli animali a fini sperimentali o ad altri fini scientifici. [in italian]. *Supplemento ordinario alla Gazzetta Ufficiale* 40: 5-25.
15. Soffritti M, Belpoggi F, Minardi F, *et al.* Mega experiments on the carcinogenicity of γ -radiation on Sprague Dawley rats at the Cancer Research Centre of the European Ramazzini Foundation of Oncology and Environmental Sciences: plan and report of early results on mammary carcinogenesis. *Eur J Oncol* 1999; 4(5): 509-22.
16. Soffritti M, Belpoggi F, Minardi F, *et al.* Mega-experiments to identify and assess diffuse carcinogenic risks. *Ann NY Acad Sci* 1995; 895: 34-55.
17. Matanoski GM, Breyese PN, Elliot EA. Electromagnetic field exposure and male breast cancer. *Lancet* 1981; 337: 737.
18. Portier CJ, Wolfe MS. Assessment of health effects from exposure to power-line frequency electric

- and magnetic fields. NIEHS Working Group Report. Research Triangle Park, NC: National Institute of Environmental Health Sciences, NIH, 1998.
19. Feychting M, Forssen U. Electromagnetic fields and female breast cancer. *Cancer Causes Control* 2006; 17: 530-58.
 20. Beniashvili DS, Bilanishvili VG, Menabde MZ. Low frequency electromagnetic radiation enhances the induction of rat mammary tumors by nitrosomethyl urea. *Cancer Lett* 1991; 61: 75-9.
 21. Löscher W, Mevissen M, Lehmacher W, *et al.* Tumor promotion in a breast cancer model by exposure to a weak alternating magnetic field. *Cancer Lett* 1993; 71(1-3): 75-81.
 22. Mevissen M, Häussler M, Lerchl A, *et al.* Acceleration of mammary tumorigenesis by exposure of 7,12-dimethylbenz[a]anthracene-treated female rats in a 50-Hz, 100-microT magnetic field: replication study. *J Toxicol Environ Health A* 1998, 53(5): 401-18.
 23. Thun-Battersby S, Mevissen M, Löscher W. Exposure of Sprague-Dawley rats to a 50-Hertz, 100-microTesla magnetic field for 27 weeks facilitates mammary tumorigenesis in the 7,12-dimethylbenz[a]-anthracene model of breast cancer. *Cancer Res* 1999; 59(15): 3627-33.
 24. Fedrowitz M, Kamino K, Löscher W. Significant differences in the effects of magnetic field exposure on 7,12-dimethylbenz(a)anthracene-induced mammary carcinogenesis in two substrains of Sprague-Dawley rats. *Cancer Res* 2004; 64(1): 243-51.
 25. Fedrowitz M, Loscher W. Power frequency magnetic fields increase cell proliferation in the mammary gland of female Fischer 344 rats but not various other rat strains or substrains. *Oncology* 2005; 69(6): 486-98.
 26. Ekström T, Mild KH, Holmberg B. Mammary tumours in Sprague-Dawley rats after initiation with DMBA followed by exposure to 50 Hz electromagnetic fields in a promotional scheme. *Cancer Lett* 1998; 123(1): 107-11.
 27. Anderson LE, Boorman GA, Morris JE, *et al.* Effect of 13 week magnetic field exposures on DMBA-initiated mammary gland carcinomas in female Sprague-Dawley rats. *Carcinogenesis* 1999; 20(8): 1615-20.
 28. Boorman GA, Anderson LE, Morris JE, *et al.* Effect of 26 week magnetic field exposures in a DMBA initiation-promotion mammary gland model in Sprague-Dawley rats. *Carcinogenesis* 1999; 20(5): 1615-20.
 29. Fedrowitz M, Loscher W. Exposure of Fischer 344 rats to a weak power frequency magnetic field facilitates mammary tumorigenesis in the DMBA model of breast cancer. *Carcinogenesis* 2008; 29(1): 186-93.

The weak combined magnetic fields induce the reduction of brain amyloid- β level in two animal models of Alzheimer's disease

Natalia V. Bobkova, Vadim V. Novikov, Natalia I. Medvinskaya,
Irina Y. Aleksandrova, Inna V. Nesterova, Eugenio E. Fesenko
Institute of Cell Biophysics of Russian Academy of Sciences, Pushchino, 142290, Russia

Abstract

Subchronic effect of a weak combined magnetic field (MF), produced by superimposing a constant component, 42 μ T, and an alternating MF of 0,08 μ T which was the sum of two signals of frequencies of 4.38 and 4.88Hz, was studied in olfactory bulbectomized and transgenic B6C3-Tg(APP^{swe},PSEN1^{DeltaE9})85DBO/J mice, which were used as animal models of sporadic and heritable Alzheimer's disease accordingly. Exposure to the MFs (4 hours for 10 days) induced the decrease of A β level in bulbectomized mice and reduced the number of A β plaques in the cortex and hippocampus of transgenic animals. However, the memory improvement was revealed in transgenic mice only, but not in the bulbectomized animals. We suggest that to prevent the A β accumulation MFs could be used at early stage of neuronal degeneration in case of Alzheimer's disease and other diseases with amyloid protein deposition in other tissues.

Key words: Alzheimer's disease; amyloid- β ; week combined magnetic fields; memory; transgenic mice; bulbectomized mice

Introduction

Amyloid- β (A β) is a key pathogenic agent in Alzheimer's disease (AD). The abnormal amyloidogenesis, leading to A β protein deposition in the extracellular and perivascular spaces of the brain, is one of the main causes of neuron death in AD. Therefore, efforts of many researchers are focused on investigation of methods to prevent A β deposition and to remove the senile plaques, formed by A β , from the brain. The efficiency of this approach was demonstrated in transgenic animals carrying the inserted human gene of A β precursor protein. Cleaning of their brain from amyloid plaques using

Address: Natalia V. Bobkova, Ph.D., Institute of Cell Biophysics Russian Academy of Sciences, str. Institutskaya 3, Pushchino Moscow region, 142290; Russia - Tel.: +7 4967 739100
E-mail: nbobkova@mail.ru

antibodies against beta-amyloid protein was accompanied by recovery of spatial memory¹. However, this method has a number of negative side effects in patients with AD². Therefore, the problem of removing of A β aggregates from the brain remains quite important.

In previous research, we studied the mechanisms of the effect of weak combined magnetic fields (MF) on properties of aqueous solutions of various biologically active ions and also proteins and peptides³⁻⁵. We used a low-frequency variable component with strength about 10 nT and a constant component with strength comparable to the geomagnetic field. According to our proposed algorithm, the frequencies of the variable component of the MF formally corresponded to the cyclotron frequencies of ionic forms of a number of amino acids at a ratio between the induction of the constant and variable components of 500–3000. Such MF combination has an extremely high biological activity; in particular, it was shown that it can accelerate the decomposition of the A β into soluble peptide fragments with a decreased neurotoxic effect and with less capability to form the insoluble aggregates^{6,7}. In that work we used a weak combined variable magnetic field of 0.05 μ T with frequencies 3.58–4.88 Hz and constant magnetic field of 42 μ T. The region of the A β molecule that was most sensitive to the weak magnetic field was located between residues Asp7 and Ser8. In this region the hydro-lysis of A β under the action of the MF took place.

In this work we used the weak combined MF with parameters closed to mention above to studied the its effect *in vivo* in two animal models of AD: well characterized mice transgenic for mutant APP^{swe} and mutant presenilin 1 (PS1^{dE9}) that cause early onset familial Alzheimer's disease (AD) and olfactory bulbectomized (OBE) mice, which showed the behavioral, morphological, immunological, and biochemical signs similar to sporadic AD. They have the pronounced impairment of spatial memory, an increased A β level in the brain, pathology in the cholinergic system, and demonstrate a loss of neurons in the brain structures responsible for memory⁸⁻¹⁵.

Methods

The experiments were carried out on 3-month-old male NMRI mice and 8-month-old male transgenic B6C3-Tg(APP^{swe},PSEN1^{DeltaE9})85DBO/J mice (JacksonLab, USA) with weigh of 25 ± 0.6 g. Animals were allowed food and water ad libitum and housed in groups of eight in standard laboratory cages under 12 :12 h light-dark conditions (light from 8.00AM) at 21–23°C. Olfactory bulbectomy was performed under Nembutal anesthesia (40 mg/kg, ip) using a 0.5% Novocain solution for local anesthesia in scalping. The olfactory bulbs were removed bilaterally by aspiration through a rounded needle attached to a water pump. Single burr hole of 2 mm diameter was drilled over the olfactory bulbs, using the stereotaxic coordinates: AP-2; L0; H 3.5. The extent of the lesion was assessed both visually and histological at the end of the experimental study. The control to OBE mice was sham-operated (SO) animals, subjected to the same procedures except the olfactory bulb ablation. The AD mouse model used in this study (APP^{swe}/PS1^{dE9}-Line 85) co-expresses a chimeric mouse/human APP695 harboring the Swedish K670M/N671L mutations (Mo/HuAPP^{swe}) and human PS1 with the exon-9 deletion mutation (PS1^{dE9}). This model was generated by co-injection of MoPrP.Xho expression plasmids for each gene; the two transgenes co-integrated and segregated as a single locus. These transgenic mice were purchased from the Jackson Laboratories

(stock # 004462; Bar Harbor, ME). C3H mice (phenotypically non-mutant mice) from the colony were the controls.

The OBE and SO animals were exposed to the weak combined MF at five weeks after bulbectomy. Transgenic mice and control C3H mice were exposed to the same MF at age of 8 months. Two groups of mice were exposed by MF at one time (OBE+MF and SO+MF, or Tg+MF and C3H+MF), which were placed in separated cages (367x207x140 mm). The setup for generating the MF consisted of two pairs of coaxial Helmholtz coils oriented along the geomagnetic field (GMF) vector. The diameter of each coil was 120 cm; the distance between the coils in the pairs was 70 cm.

The GMF partially compensated to $42 \pm 0.1 \mu\text{T}$ using one pair of Helmholtz coils served as a DC. The alternating component collinear to the DC field was formed using the second pair of Helmholtz coils. An alternating current signal produced by a programmable sinusoidal current generator was fed to other pair of coils to create a variable component of MF with induction of amplitude of 80 nT. The current signal was the sum of two frequencies of 4.38 and 4.88 Hz, which correspond to the cyclotron frequencies of lysine and aspartic acid, respectively, as calculated by the standard expression

$$v_c = q\mathbf{B}/2\pi m,$$

where q and m are the charge and mass of an amino acid ion.

The MFs were measured with a Mag-03 MS 100 three-axial MF sensor (Bartington Instruments Ltd, United Kingdom). The animals were exposed to MF in 4-h daily sessions for 10 days. The experiments were carried out in the presence of the natural and technogenic magnetic backgrounds with an induction of 50-Hz component of 20–40 nT in the daytime between 10 and 18 h at room temperature (18–22°C) under conditions of natural illumination. The SO, OBE, transgenic (Tg), and C3H animals without exposure to the weak combined MF were groups of active controls. They were under activity of natural geomagnetic field with an induction of 40–42 μT and at the same magnetic noise level as for the test groups. After exposure to the MF, the mice were trained in a Morris water maze for 5 days (four trials per day) for the olfactory bulbectomy experiment and for 18 days in the transgenic-mouse experiment. Experiments were performed in a test room with extra-maze cues to facilitate spatial learning. A circular swimming tank (80 cm diameter and 40 cm wall height with an escape platform of 5 cm-diameter) was filled to depth of 30 cm with water at 23°C and rendered opaque by adding powdered milk. The tank was mentally divided into four sectors: the escape platform was located in the middle of the third quadrant during training. It was submerged to a depth of 0.5 cm so as to be invisible to a swimming animal during the whole period of training. Latency to reach the invisible platform was then determined. If the animals failed to locate the platform within test period for 60 s, they were placed on the platform for 10 s. Spatial memory was tested on the following day after completion of training with the hidden platform removed. During the test period (60 s), occupancy time spent in each sector was recorded. After termination of behavioral experiments, cerebral perfusion was carried out with cooled physiological solution under ethyl ether narcosis.

All animal experiments were performed in accordance with the guidance of the National Institutes of Health for Care and Use of Laboratory Animals, NIH Publications No. 8023, revised 1978.

Brains of OBE and SO mice were removed, frozen on dry ice and stored at -80°C for biochemical studies. The brains of Tg animals and C3H mice were immersion-fixed in 4% paraformaldehyde in phosphate-buffered saline (PBS pH 7.4). Then, the fixed tissues were kept in sucrose solution in phosphate-buffered saline (PBS, pH 7.4; -20°C).

The A β level was determined in extracts of the cortex and hippocampus of OBE and SO mice using a modified DOT analysis described earlier¹¹. In this method, a nitrocellulose membrane was pretreated for 1 min with 40% ovalbumin in phosphate buffer and then for 10 min with 2.5% glutaraldehyde, samples were applied to the membrane, and the membrane was kept for 1 h in 4% ovalbumin in phosphate buffer with 0.1% NaN₃.

Estimation of amyloid plaque loads was performed by counting amyloid plaques, staining with thioflavine S, in 10 fields of view (magnification x20) in the each sixth brain sections (a slice thick 10 μ m) of the next brain areas: in the CA1 and CA3 fields of the hippocampus and temporal cortex of Tg mice. Images were captured by digital photography. The amyloid deposits contained within fields of view were counted separately by their sizes (magnification x40): big plaques with maximal diameter > 30 μ m, medium plaques 18 μ m < maximal diameter < 30 μ m, and small ones with maximal diameter < 18 μ m. The number of plaques of each size in a sample were summed and then averaged for each group of animals. Statistical analyses (2-tailed t-test) were performed using the average number of deposits with different sizes in the fields of the hippocampus and cortex for group of mice exposed to the weak combined MF and without exposition.

Statistical analysis

Differences in memory parameters were evaluated by a one-way ANOVA (statistical package "Statistica 6.0"). The statistical significance of preference for the target sector as compared with other indifferent sectors was evaluated using a post-hoc analysis with the LSD criterion. The water-maze acquisition latencies, level of cerebral A β in OBE mice and the difference of A β plaque density in Tg animals were evaluated using the two-tailed Student's test. All data were expressed as mean \pm sem.

Results and discussion

The data in Table 1 show that the latencies to reach the escape platform were increased significantly in OBE and OBE+MF groups in comparison to SO mice as well as in Tg animals in comparison to Tg+MF mice in last days of training as rule. The average latency in the SO animals was significantly lower than in the OBE mice. It indicates the decreased ability to study spatial skills in the OBE animals. The exposure to the MF decreased the average latency only in SO mice, but did not differ it in OBE, C3H, and Tg animals (Table 1 groups OBE+MF; C3H+MF, Tg+MF). We suggest that the MF does not affect the learning rate in OBE, C3H, and Tg mice and that the SO animals have an increased sensitivity to the MF. It is necessary to indicate, that C3H mice needed in more training sessions than SO animals to study the spatial skills. It is important to make remark, that beginning from 13th day of training Tg+MF mice had lower latency to find the escape platform than control Tg mice.

The results of the factor analysis, presented in Table 2, demonstrate that factors of the sector preference became statistically significant for Tg, but not for OBE groups after MFs exposure.

The SO animals exposed to the same MF demonstrated a significant increase in the factor of sector preference. It was due to the recognition of the sector, where escape platform is located during training, as the results of the Post hoc analysis revealed (fig. 1A).

Table 1 - Effect of the weak combined MF on latency (s) to find the escape platform in BE, SO, Tg, and C3H mice during days of training

Groups of animals	Days of the Training						Average of Latency, s
	1	2	3	4	5		
Training							
OBE	46.8±4.1	29.9±6.0	16.7±4.4	17.1**±2.5	17.0*±5.3	25.5**±2.3	
OBE+MF	36.3±5.2	30.8±5.0	19.1**±4.1	22.5**±4.1	12.0±3.2	24.1*±2.2	
SO	37.4±7.1	19.4±5.5	11.7±2.2	7.5±2.1	7.3±1.9	16.7±2.3	
SO+MF	41.4±6.4	11.8±4.0	11.3±3.0	7.8±1.5	9.2±1.8	12.3*±1.8	
	1-3	4-6	7-9	10-12	13-15	16-18	Average of Latency, s
Tg	48.0*±2.5	35.8±5.0	25.3±1.9	26.6±1.9	25.4±2.5	28.4±2.9	28.3±1.9
Tg+MF	45.3±2.5	37.0±2.7	27.2±2.7	24±2.5	21.3#±1.3	21#±2.5	26.1±2.9
C3H	40.3±3.1	35.0±3.0	26.5±2.7	21.2±2.3	18.6±2.5	15.7±2.9	23.4±3.4
C3H+MF	44.2±2.9	44.7±9.5	27.0±2.5	25.0±2.2	22.2±2.7	21.3±2.7	28.0±4.3

*-p<0.05; ** -p<0.01 relatively to control (SO or C3H) groups; MFs exposure

#-p<0.05 relatively to Tg group

Table 2 - The means of Factor of the recognizing of the Morris water maze sectors by time spent there in BE, SO, Tg, and C3H mice exposed to the weak MF

Groups of animals	Mean of the Factor	
	F	P
SO	F(3,12)=3.73	0.042*
SO+MF	F(3,12)=30.18	0.000***
OBE	F(3,12)=2.18	0.140
OBE+ MF	F(3,16)=0.64	0.600
C3H	F(3,12)=4.12	0.034*
C3H+MF	F(3,12)=3.98	0.039*
Tg	F(3,12)=2.07	0.210
Tg+MF	F(3,12)=3.11	0.049*

* = p<0.05 and *** p<0.001

Thus, the behavioral study revealed that the OBE mice did not remember the sector, in which the saving platform was located during training. It supports our previous data on the impairment of the spatial memory in OBE animals^{11, 14}. The subchronic exposure to the weak MFs did not affect spatial memory of these animals. However, the MFs improved the memory not only in SO mice, but in Tg animals too. We detected influence of the MFs on the brain Aβ. Table 3 presents the absolute values of Aβ level in the extracts of the neocortex and the hippocampus in OBE and SO after exposure of MFs. The sensitive DOT analysis revealed that the Aβ level in the extracts of the OBE animals was more than five times higher (p < 0.001) in comparison to SO mice. The exposure to the weak combined MFs induced the reliably decrease the Aβ level almost threefold (p < 0.01), but it was higher than in SO mice (p < 0.05).

Similar effect of MFs on Aβ deposits was revealed in Tg mice. Fig. 2 demonstrates that Tg+MF group showed the decreased density of plaques with small and middle sizes

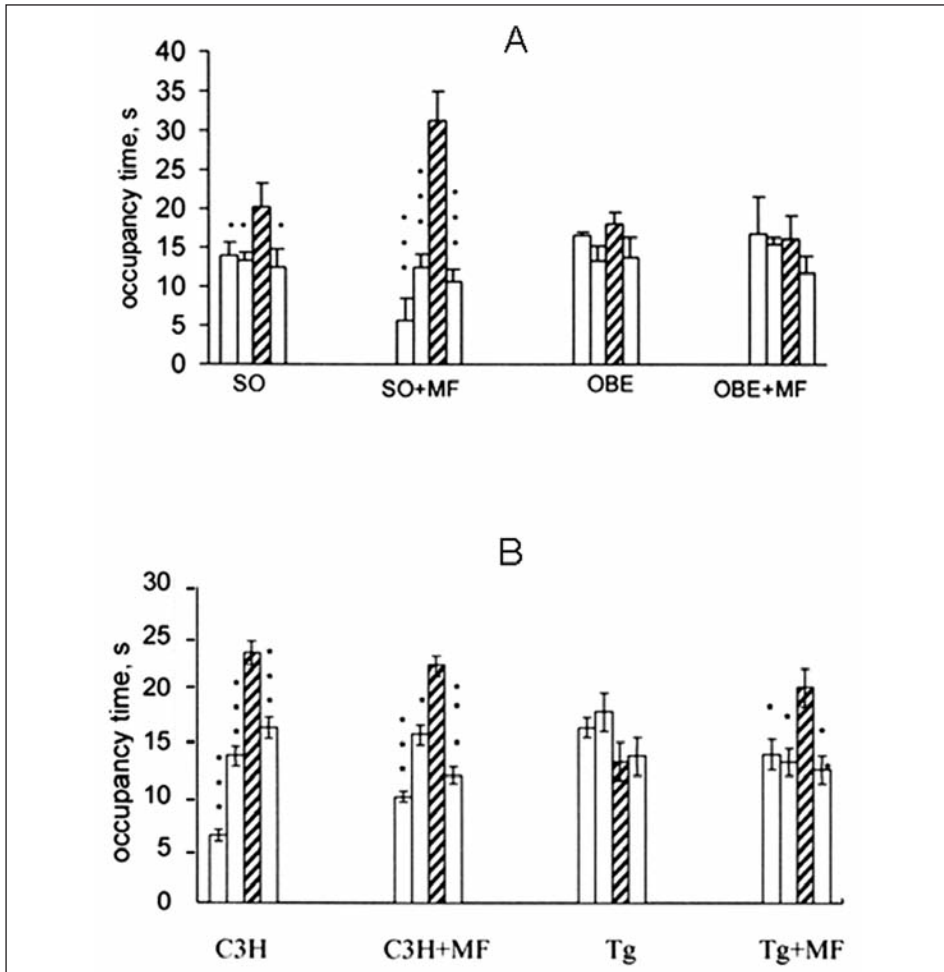

Fig. 1. Effect exposure of the weak MFs on the spatial memory of OBE and SO mice (A), as well as Tg, and C3H animals (B). The ordinate is the time spent in each sector of a Morris water maze. The hatched bin represents the time in sector in which escape platform was located during training: the empty bins denote time in indifferent sectors of the water maze. The significance of differences is indicated between sector in which escape platform was located during training and other sectors * $p < 0.05$, ** $p < 0.01$ and *** $p < 0.001$. The other notations are as in Table 1

Table 3 - The level of the brain A β in OBE and SO mice exposed to the weak MFs.

Groups of animals	The level of the brain beta-amyloid, ng/g
SO	5.03 \pm 0.36
SO+MF	5.21 \pm 0.37
OBE	34.12 \pm 4.17***
OBE+MF	10.91 \pm 2.17*##

The significance of differences from the group of SO mice: * $p < 0.05$ and *** $p < 0.001$. The significance of differences from the group of OBE mice: ## $p < 0.01$.

in the cortex and with large and middle size in the CA3, field of the hippocampus. In CA1 field the tendency of the increase of small plaques was observed follow the decrease of density of plaques with middle sizes.

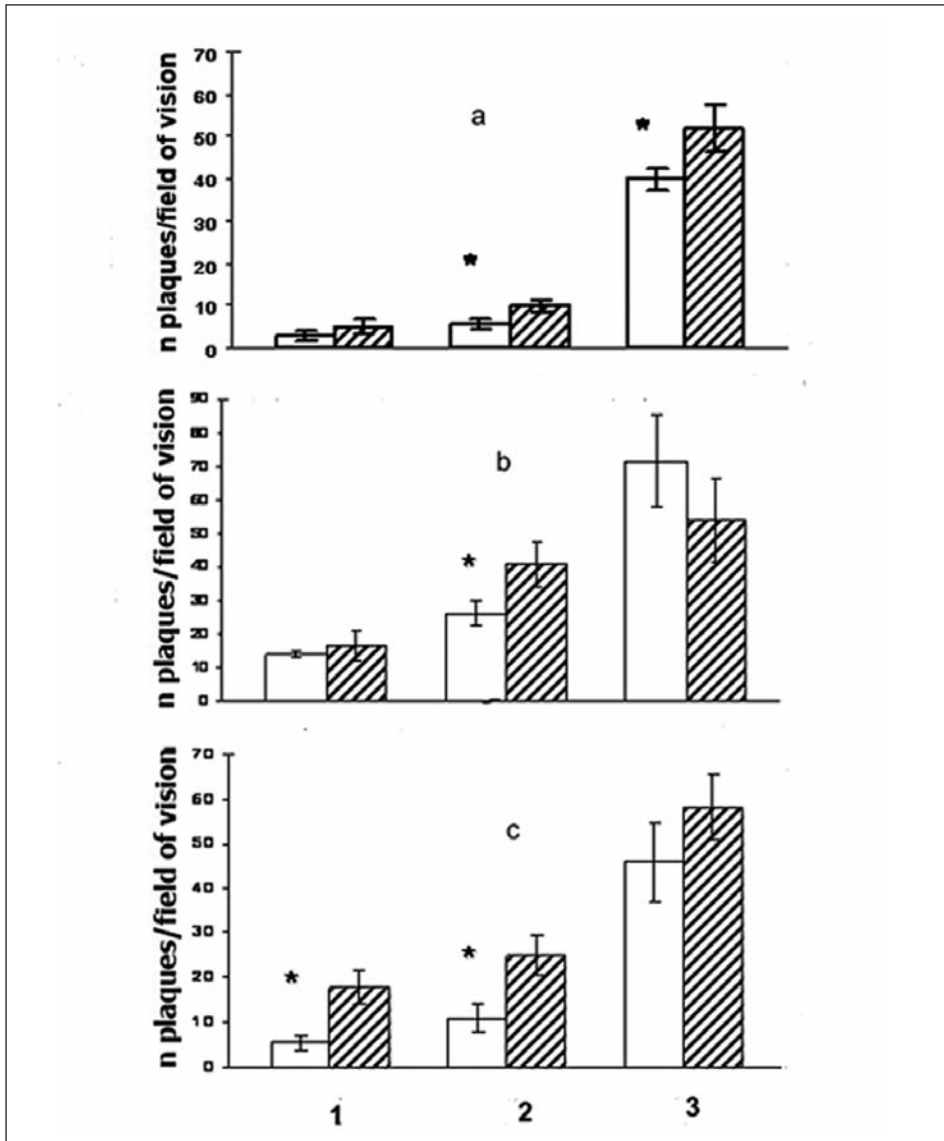

Fig. 2. Density of the amyloid plaques in the temporal cortex (A), in CA1 (B), and in CA3 (C) fields of the hippocampus in transgenic mice – model of family AD after subchronic exposure of weak combined MFs. 1- density of plaques with size >30 μk; 2- density of plaques with 18 μk < size < 30 μk; 3- density of plaques with size < 18 μk. The empty bins denote density of plaques in Tg+MF mice. The hatched bins represents the density of plaques in control group of Tg mice without exposure to MFs. The significance of differences is indicated between density of plaques with similar size in Tg+MF and Tg groups of mice in different brain structures.*p < 0.05

Thus, we revealed the reduction of the A β level in the brain of OBE mice and decrease the number of large and middle amyloid plaques after exposure to the weak combined MFs. We revealed the improving of the spatial memory in the group of transgenic mice, but we failed to detect the improving of such kind memory in OBE animals. The different effects of the weak MFs on spatial memory in animals of these two models of AD may be explained by different causes. Positive influence of MFs in Tg mice is in accordance to the main amyloid hypothesis of AD genesis, that it is enough to destroy of beta-amyloid plaques to improve the state of the brain and memory. It seems, that in case of transgenic mice the reduction of the A β -plaques is really sufficient to improve their memory, because it is shown, that A β -deposits impair the memory in transgenic animals due to impairment of impulse transmission in axons and dendrites. It is interesting, that high frequency electromagnetic field reverses cognitive impairment in AD transgenic mice and decreases brain A β aggregation too¹⁶. The precise mechanisms of MF benefit will require more extensive research in future. It is important to note, that neurons survive in majority of transgenic models of AD including model used in our experiments too¹⁷. However, in OBE animals, as our investigation showed earlier, there are the death of neurons especially in the brain areas which are responsible for learning and memory in such as the temporal cortex, the hippocampus, nuclei synthesizing the main neurotransmitters^{10, 13-15}. Here it is necessary to point out again why we decided to use the OBE mice in our study. The problem regarding an adequate use of an animal model is a principal one in any research, because it allows of drawing a correct conclusion from the results. Olfactory bulbectomy in animals elicits various behavioural abnormalities, such as increased exploratory behaviour¹⁸, impaired learning and memory⁸⁻¹⁰ and depressive behaviour^{19,20}. Distinctive features of OBE animals include loss of neurons in the cortex and hippocampus as well as cholinergic system dysfunction in basal forebrain^{8,10,14}. They show the membrane pathology, free radical generation and apoptosis²¹⁻²³, as well as impairment of brain asymmetry²⁴. OBE mice were shown to have impaired hippocampal long-term potentiation²⁵. As was mentioned in the Introduction, OBE mice have an increased level of the brain amyloid precursor protein²⁶ and A β ¹¹. Therefore, OBE mice have some features similar to AD, including memory impairment, depressive state, cholinergic system dysfunction, loss of neurons and an increased A β level in the brain, and olfactory deficit^{27,28}. It is important that alterations in neurotransmitter and receptor functions, mediating abnormal behavioral effects of olfactory bulbectomy, are also similar to those in AD patients. Deficit in serotonergic function was associated with depressive behaviour in OBE rats^{13,29}. The serotonergic system was profoundly affected in AD: a very low or undetectable serotonin concentration was observed in most cortical and subcortical areas in senile sporadic as well as in presenile familial-type AD³⁰. Moreover, olfactory bulbectomy-induced and AD-related memory deficits were suggested to share common cellular mechanisms including dysfunction of the cholinergic system and NMDA receptors²⁸. Therefore, we consider that OBE mice were suitable as model of sporadic AD to investigate the MF effect on memory and level of A β in the brain.

Therefore, we suggest that exposure to MFs is a useful procedure to decrease the level of brain A β in family as well as in sporadic AD. However we think, that its would be applied prior to the loss of neurons in the brain, i.e. on earlier stage of the AD development. In this case the weak combined MFs can be an efficient way to prevent the AD. The decrease of A β in the brain of Tg and OBE mice may be consequence of A β decomposition under exposure of the weak combined MF⁷. Less A β depositions may

decrease the brain A β aggregation due to blocking the apolipoprotein E/A β interaction³¹. Note that there are different points of view on the effect of MF on the neurodegenerative processes. Some researchers consider the exposure to MF as a potential risk factor for neurodegenerative diseases³²⁻³⁴, whereas others deny it³⁵. Furthermore, there is evidence of a beneficial effect of MF on the cognitive processes and the visual memory in patients with AD, Parkinson's disease, and multiple sclerosis³⁶⁻³⁸. However some researchers suspect that such very low strength MFs can have much of a biological influence. The MF using opens new possibilities of treating this severe disease. Another way to increase the MF efficiency is the variation of its parameters. MFs have a broad effect on biological systems. The middle of the eighties was marked with the discovery by Blackman and Liboff^{39,40} of a surprising phenomenon: a low frequency alternating (AC) MF (1-120 Hz) changed free calcium concentration in nervous tissue only in the presence of a simultaneously acting static (DC) MF. The most prominent effect was observed at the AC field frequency close to the cyclotron frequency of a calcium ion. There were three unexpected qualities in this phenomenon: 1) the necessity of simultaneous action of DC and AC MFs, 2) the resonance effect on cyclotron frequency, and 3) very small values of acting MFs, measured with tens of μ T, and extremely low frequencies of AC MFs, measured with several tens of Hz. Therefore, these results evoked a suspicion in the scientific community, but afterwards, many confirmations for these data were obtained in works performed on different objects and in different experimental situations⁴¹⁻⁴⁹ which captured the interest of the scientific community about the existence of the above effects. In the middle of the nineties a series of experiments were made, on aqueous solutions of amino acids. At the cyclotron frequencies measured by several Hz, which corresponded to the investigated amino acid ions, and at superweak alteration MFs measured by tens of nT, the short-term increase in the current caused by application of the voltage to the investigated solution was revealed. These results were published in Russian journal "Biophysics"⁵⁰. Afterwards the experiment and results described in the above article were successfully replicated in Italy^{51,52} and in Germany⁵³. These works confirmed the existence of such effects. Now new effects of the weak combined MF have received. It was shown that MF inhibits malignant tumor growth in experimental animals⁵³. The parameters of this MF have been found (frequency 1, 4.4, 16.5 Hz or the sum of these frequencies; intensity 300, 100, 150-300 nT, respectively) at which this MF in combination with a collinear static MF of 42 μ T has this effect. Very likely it was due to stimulation of tumor necrosis factor production⁵⁵. Such kind MFs influences on the formation of reactive oxygen species⁵⁶ and hydrogen peroxide production⁵⁷, changes the microenvironment of protein macromolecules in aqueous solutions⁵⁸, accelerates the spontaneous hydrolysis of proteins and peptides to form peptide fragments^{5, 6}, influences on the fission and regeneration of the planarian⁵⁹. Italian researchers have showed, that extremely low-frequency electromagnetic fields (ELF-EMFs), tuned at Ca²⁺ ion cyclotron energy resonance may drive cardiac-specific differentiation in adult cardiac progenitor cells without any pharmacological or genetic manipulation of the cells that may be used for therapeutic purposes⁵⁹. A lot of researchers suggest that the nervous system is very sensitive to weak MFs⁴⁹. There is evidence that MF selectively activates the limbic structures of the brain, which suffer in patients with AD. Therefore our results, attained in AD transgenic and OBE mice, suggest that weak combined MF with low frequency could be used as method for cleaning of the brain from A β in patients with AD. The decrease of plaques with insoluble A β would increase brain soluble A β

levels, and result in greater clearance of that soluble A β from the brain. Moreover, we suggest that such MF can be applied for preventive purposes not only in humans with high risk of AD, but in case of other diseases involving amyloid protein deposition in other tissues.

References

1. Solomon B. Immunotherapeutic strategies for Alzheimer's disease treatment. *Scientific World Journal* 2009; 9: 909-19.
2. Holtzman D. Alzheimer's disease: moving towards a vaccine. *Nature* 2008; 454(7203): 418-20.
3. Zhadin M, Novikov V, Barnes F, *et al.* Combined action of static and alternating magnetic fields on ionic current in aqueous glutamic acid solution. *Bioelectromagnetics* 1998; 19: 41-5.
4. Novikov V. Electromagnetic bioengineering. *Biofizika* 1998; 43: 588-93.
5. Novikov V, Fesenko E. Hydrolysis of some peptides and proteins in weak combined static and low-frequency alternating magnetic fields. *Biofizika* 2001; 46: 235-41.
6. Fesenko E, Novikov V, Bobkova N. Destruction of amyloid beta-protein by exposure to weak magnetic fields. *Biofizika* 2003; 48(2): 217-20.
7. Fesenko E, Novikov V, Bobkova N. Weak combined magnetic field accelerates hydrolysis of β amyloid-protein in vitro. *PIERS Proceedings* 2009; 1148-52.
8. Nesterova I, Gurevich E, Nesterov V, *et al.* Bulbectomy-induced loss of raphe neurons is counteracted by antidepressant treatment. *Prog Neuropsychopharmacol Biol Psychiatry* 1997; 21(1): 127-40.
9. Yamamoto T, Jin J, Watanabe S. Characteristics of memory dysfunction in olfactory bulbectomized rats and the effects of cholinergic drugs. *Behav Brain Res* 1997; 83: 57-62.
10. Hozumi S, Nakagawasai O, Tan-No K, *et al.* Characteristics of changes in cholinergic function and impairment of learning and memory-related behavior induced by olfactory bulbectomy. *Behav Brain Res* 2003; 138: 9-15.
11. Aleksandrova I, Kuvichkin V, Kashparov I, *et al.* Increased level of beta-amyloid in the brain of bulbectomized mice. *Biochemistry (Mosc)* 2004; 69(2): 176-80.
12. Bobkova N, Medvinskaya N, Nesterova I, *et al.* Possible role of olfactory system in Alzheimer's disease genesis. In Fisher A, Hanin I, Memo M, Stocchi F, eds. *New Trends in Alzheimer's and Parkinson Disorders ADPD*. Medimond, 2005, 91-5.
13. Nesterova I, Bobkova N, Medvinskaya N, *et al.* Morphofunctional state of neurons in the temporal cortex and hippocampus in relation to the level of spatial memory in rats after ablation of the olfactory bulbs. *Neurosci Behav Physiol* 2008; 38(4): 349-53.
14. Bobkova N, Nesterova I, Dana R, *et al.* Morphofunctional changes in neurons in the temporal cortex of the brain in relation to spatial memory in bulbectomized mice after treatment with mineral ascorbates. *Neurosci Behav Physiol* 2004; 34(7): 671-6.
15. Bobkova N, Nesterova I, Nesterov V. The state of cholinergic structures in forebrain of bulbectomized mice. *Bull Exp Biol Med* 2001; 131(5): 427-31.
16. Arendash G, Sanchez-Ramos J, Mori T, *et al.* Electromagnetic field treatment protects against and reverses cognitive impairment in Alzheimer's disease mice. *J Alzheimers Dis* 2009; [Epub ahead of print]
17. Takeuchi A, Irizarry M, Duff K, *et al.* Age-related amyloid beta deposition in transgenic mice overexpressing both Alzheimer mutant presenilin 1 and amyloid beta precursor protein Swedish mutant is not associated with global neuronal loss. *Am J Pathol* 2000; 157(4): 1413-8.
18. Sieck M. The role of the olfactory system in avoidance learning and activity. *Physiol Behav* 1972; 8(4): 705-10.
19. Leonard B, Tuite M. Anatomical, physiological, and behavioral aspects of olfactory bulbectomy in the rat. *Int Rev Neurobiol* 1981; 22: 251-86.
20. Song C, Leonard B. The olfactory bulbectomized rat as a model of depression. *Neurosci Biobehav Rev* 2005; 29(4-5): 627-47.
21. Leung C, Wilson D. Trans-neuronal regulation of cortical apoptosis in the adult rat olfactory system. *Brain Res* 2003; 984(1-2): 182-8.
22. Koliatsos V, Dawson T, Kecojevic A, *et al.* Cortical interneurons become activated by deafferenta-

- tion and instruct the apoptosis of pyramidal neurons. *Proc Natl Acad Sci USA* 2004; 101(39): 14264-9.
23. Capurso S, Calhoun M, Sukhov R, *et al.* Deafferentation causes apoptosis in cortical sensory neurons in the adult rat. *J Neurosci* 1997; 17(19): 7372-4.
 24. Bobkova N, Vorobyov V, Medvinskaya N, *et al.* Interhemispheric EEG differences in olfactory bulbectomized rats with different cognitive abilities and brain beta-amyloid levels. *Brain Res* 2008; 1232: 185-94.
 25. Han F, Shioda N, Moriguchi S, *et al.* The vanadium (IV) compound rescues septo-hippocampal cholinergic neurons from neurodegeneration in olfactory bulbectomized mice. *Neuroscience* 2008; 151(3): 671-9.
 26. Struble R, Dhanraj D, Mei Y, *et al.* Beta-amyloid precursor protein-like immunoreactivity is upregulated during olfactory nerve regeneration in adult rats. *Brain Res* 1998; 780(1): 129-37.
 27. Warner M, Peabody C, Flattery J, *et al.* Olfactory deficits and Alzheimer's disease. *Biol Psychiatry* 1986; 2: 116-8.
 28. Moriguchi K, Han F, Nakagawasai O, *et al.* Decreased calcium/calmodulin-dependent protein kinase II and protein kinase C activities mediate impairment of hippocampal long-term potentiation in the olfactory bulbectomized mice. *J Neurochem* 2006; 97: 22-9.
 29. Van der Stelt H, Breuer M, Olivier B, *et al.* Permanent deficits in serotonergic functioning of olfactory bulbectomized rats: an in vivo microdialysis study. *Biol Psychiatry* 2005; 57(9): 1061-7.
 30. Herregodts P, Bruyland M, De Keyser J, *et al.* Monoaminergic neurotransmitters in Alzheimer's disease. An HPLC study comparing presenile familial and sporadic senile cases. *J Neurol Sci* 1989; 92(1): 101-16.
 31. Sadowski M, Pankiewicz J, Scholzova H, *et al.* Blocking the apolipoprotein E/amyloid β interaction reduces the parenchymal and vascular amyloid- β deposition and prevents memory deficit in AD transgenic mice. *Proc Natl Acad Sci USA* 2006; 103: 18787-92.
 32. Håkansson N, Gustavsson P, Johansen C, *et al.* Neurodegenerative diseases in welders and other workers exposed to high levels of magnetic fields. *Epidemiology* 2003; 14(4): 420-6.
 33. Hug K, Rössli M, Rapp R. Magnetic field exposure and neurodegenerative diseases - recent epidemiological studies. *Soz Präventivmed* 2006; 51(4): 210-20.
 34. García A, Sisternas A, Hoyos S. Occupational exposure to extremely low frequency electric and magnetic fields and Alzheimer disease: a meta-analysis. *Int J Epidemiol* 2008; 37: 329-40.
 35. Kheifets L, Bowman J, Checkoway H, *et al.* Future needs of occupational epidemiology of extremely low frequency electric and magnetic fields: review and recommendations. *Occup Environ Med* 2009; 66(2): 72-80.
 36. Sandyk R. Alzheimer's disease: improvement of visual memory and visuoconstructive performance by treatment with picotesla range magnetic fields. *Int J Neurosci* 1994; 76(3-4): 185-225.
 37. Sandyk R. Improvement in short-term visual memory by weak electromagnetic fields in Parkinson's disease. *Int J Neurosci* 1995; 81(1-2): 67-82.
 38. Sandyk R, Iacono R. Improvement by picoTesla range magnetic fields of perceptual-motor performance and visual memory in a patient with chronic progressive multiple sclerosis. *Int J Neurosci* 1994; 78(1-2): 53-66.
 39. Blackman C, Benane S, House D, *et al.* Effects of ELF (1–120 Hz) and modulated (50 Hz) RF fields on the efflux of calcium ions from brain tissue in vitro. *Bioelectromagnetics* 1985; 6: 1-11.
 40. Liboff A. Cyclotron resonance in membrane transport. In: Chiabrera A, Nicolini C, Schwan HP, eds. *Interaction between Electromagnetic Fields and Cells*. London: Plenum Press, 1985; 281-96.
 41. Liboff A, Smith S, McLeod B. Experimental evidence for ion cyclotron resonance mediation of membrane transport. In: Blank M, Findl E. *Mechanistic approaches to interaction of electric and electromagnetic fields with living systems*. New York: Plenum Press 1987; 109-32.
 42. Rochev Y, Narimanov A, Sosunov E, *et al.* Effect of weak magnetic field on the rate of cell proliferation in culture. *Studia Biophysica* 1990; 2: 93-8.
 43. Lerchi A, Reiter R, Howes K, *et al.* Evidence that extremely low frequency Ca-cyclotron resonance depresses pineal melatonin synthesis in vitro. *Neurosci Lett* 1991; 124: 213-5.
 44. Persson B, Lindvall M, Malmgren L, *et al.* Interaction of low-level combined static and extremely low-frequency magnetic fields with calcium transport in normal and transformed human lymphocytes and rat thymic cells. In Norden B, Ramel C, eds: *Interaction mechanisms of low-level electromagnetic fields and living systems*. Oxford: Oxford Univ Press; 1992, 199-209.

45. Yost M, Liburdy R. Time-varying and static magnetic fields act in combination to alter calcium signal transduction in the lymphocyte. *FEBS Lett* 1992; 296: 117-22.
46. Lovely R, Creim J, Miller D, *et al.* Behavior of rats in a radial arm maze during exposure to magnetic fields: evidence for effects of magnesium ion resonance. 15th Annual Meeting BEMS 1993; Abstract E1-6, 1993.
47. Smith S, McLeod B, Liboff A. Effects of CR-tuned 60 Hz magnetic fields on sprouting and early growth of *Raphanus-sativus*. *Bioelectrochem Bioenergetics* 1993; 3: 67-76.
48. Blackman C, Blanchard J, Benane S, *et al.* Empirical test of an ion parametric resonance model for magnetic field interactions with PC-12 cells. *Bioelectromagnetics* 1994; 15: 239-60.
49. Zhadin M, Deryugina O, Pisachenko T. Influence of combined DC and AC magnetic fields on rat behavior. *Bioelectromagnetics* 1999; 20: 378-86.
50. Novikov V, Zhadin M. Combined action of weak constant and variable low-frequency magnetic fields on ionic currents in aqueous solutions of amino acid. *Biophysics* 1994; 39: 41-5.
51. Del Giudice E, Fleischmann M, Preparata G, *et al.* On the “unreasonable” effects of ELF magnetic field upon a system of ions. *Bioelectromagnetics* 2002; 23: 522-30.
52. Comisso N, Del Giudice E, De Ninno A, *et al.* Dynamics of the ion cyclotron resonance effect on amino acids adsorbed at the interfaces. *Bioelectromagnetics* 2006; 27: 16-25.
53. Pazur A. Characterisation of weak magnetic field effects in an aqueous glutamic acid solution by nonlinear dielectric spectroscopy and voltammetry. *Biomagnetic Res Technol* 2004; 2: 8.
54. Novikov V, Novikov G, Fesenko E. Effect of weak combined static and extremely low-frequency alternating magnetic fields on tumor growth in mice inoculated with the ehrlich ascites carcinoma. *Bioelectromagnetics* 2009; 30: 343-51.
55. Novoselova E, Ogai V, Sorokina O, *et al.* Effect of electromagnetic waves of the centimeter range and combined magnetic field on the production of the tumor necrosis factor in cells of mice with experimental tumors. *Biofizika* 2001; 46: 131-5.
56. Ponomarev V, Novikov V. Effect of low-frequency alternating magnetic fields on the rate of biochemical reactions proceeding with the formation of reactive oxygen species. *Biofizika* 2009; 54(2): 235-41.
57. Ponomarev V, Novikov V, Karnaukhov A, *et al.* Effect of a weak electromagnetic field on the rate of hydrogen peroxide production in aqueous solutions. *Biofizika* 2008; 53(2): 197-204.
58. Fesenko E, Novikov V, Kuvichkin V, *et al.* Effect of treated with weak magnetic field aqueous salt solutions on the intrinsic fluorescence of bovine serum albumin. Isolation from solutions and partial characterization of the biologically active fluorescing fraction. *Biofizika* 2000; 45(2): 232-9.
59. Novikov V, Sheiman I, Fesenko E. Effect of weak static and low-frequency alternating magnetic fields on the fission and regeneration of the planarian *Dugesia (Girardia) tigrina*. *Bioelectromagnetics* 2008; 29: 387-93.
60. Gaetani R, Ledda M, Barile L, *et al.* Differentiation of human adult cardiac stem cells exposed to extremely low-frequency electromagnetic fields. *Cardiovasc Res* 2009; 82(3): 411-20.

Delayed maturation of *Xenopus laevis* (Daudin) tadpoles exposed to a weak ELF-MF: sensitivity to small variations of magnetic flux density

Maurizio Severini, Luigi Bosco

Department of Ecology and Economical Sustainable Development, DECOS, Tuscia University, Viterbo, Italy

Abstract

In a previous experiment, we showed that exposure to a relatively weak ELF magnetic field slows down developmental rate of *Xenopus laevis* (*X. laevis*) tadpoles with respect to non-exposed controls. Here, the data of the same experiment are re-processed to evaluate the sensitivity of tadpole developmental rate to small variations of (weak) ELF magnetic flux densities.

Taking advantage of a slight anisotropy of field strength along the axis of a large solenoid, two cohorts of *X. laevis* tadpoles were reared under a 50 Hz magnetic field of two slightly different flux densities. The small (but highly significant; $p < 0.001$) difference of exposure caused a significant difference of 2.5 days ($p < 0.05$) in tadpole's maturation rate. Results suggest the existence of a field threshold around 70 μT in controlling the animal's developmental rate. However, considering results of similar researches, we suggest to perform further experimental researches on other laboratory animal models and to individuate the key developmental passages affected by ELF MF before proceeding to some generalization of disturbs of these fields in vivo.

Key words: ELF-MF; developmental rate; *Xenopus laevis* tadpoles

Introduction

After alarm that exposure to extremely low frequency (ELF) magnetic fields (MF) in proximity of high voltage power lines increases risk of childhood leukemia¹, epidemiology failed to give a convincing scientific justification of it². Our opinion is that, until laboratory experiments on cell or animal models will not give a clear indication of a well defined mechanism of action of electromagnetic fields (EMF) on living systems, statistical approaches in bio-magnetism will not have an effect to test with success at popula-

Address: Prof. Maurizio Severini, Largo dell'Università SNC, 01100 Viterbo, Italia
E-mail: m.severini@unitus.it

tion level, and their outcomes will remain questionable. We draw this conclusion after reading the comprehensive study 'Review of the epidemiologic literature on EMF and health' by Ahlbom *et al.*³. Then in this work, we are going to refer mainly to laboratory studies of cell or animal exposures. By our knowledge, experimental research on biological effects of ELF-MF exposures initiated with 'Sanguine' project⁴. Afterwards, a long series of experiments highlighted numerous (and sometimes contrasting) mechanisms of action of EMF on living systems and possible *window* (or *threshold*) effects of weak ELF-MF, but they did not give reliable dose-effect or frequency-effect relationships between exposures and their biological consequences.

The hypothesis of a *window effect* of weak ELF-MF was first suggested by Kaczmarek and Adey⁵. They observed a flux of radioactive calcium in chick brain cells caused by exposure to a weak low frequency electric field, and showed that the flux depended on the field frequency with a maximum at 16 Hz. Later on, Blackman *et al.*⁶ repeated the exposures of chicken brains to 16 Hz with variable weak field amplitudes and noted sharp increases of calcium flux around 6 V/m and 40 V/m that were interpreted as biological *threshold effects* of field amplitudes. Independent replicas of the Adey-Blackman experiment by Delgado *et al.*⁷ and Ubeda *et al.*⁸ confirmed the existence of threshold (or window) effects of ELF MF on biological tissues but disagreed on frequency and amplitude values. Later on, Blackman *et al.*⁹ explained the disagreement by highlighting the role of two different magnetic fields: a) the local static geomagnetic field and b) the weak magnetic field associated with the electromagnetic one. Afterwards, magnetic fields were of main interest in studies of biological effects of weak low frequency electromagnetic fields. Along this way, Liboff¹⁰ interpreted the Blackman's explanations by applying the physical theory of cyclotronic resonance to ions of calcium in organic matter, and performed experiments to support his interpretation^{11, 12}. Later, Zhadin *et al.*¹³ supported Liboff's ideas by claiming to have observed effects of cyclotronic resonance in an electrolytic solution. The Liboff-Zhadin point of view attracted (and still attracts) many criticisms, the most serious among them being that thermal agitation would overrule the effects of cyclotronic resonance¹⁴. In the same time, other researchers attempted to follow other ways for explaining biological effects of ELF MF exposures. Reiter¹⁵ considered the melatonin hormone as a possible mediator of low frequency magnetic fields in animals and humans. Cridland *et al.*¹⁶ focused on a possible action of ELF MF exposures on cell cycle progression, Harris *et al.*¹⁷, and Takashima *et al.*¹⁸ exhibited evidences that the action consists of a depression of the cell cycle check points. Recently, Blank¹⁹ claimed that weak magnetic fields can alter intramolecular charges and influence action of growth factors.

Most of the above cited studies refer to experiments on a micro-scale *in vitro*. As it is well known, each primary interaction between biological matter and radiation on a molecular scale must pass through a chain of events before emerging on a macro-scale (that of organisms) *in vivo*, Valberg *et al.*²⁰. Very often, a lesion at a small scale does not cause any observable consequence at organism's level thanks to the intervention of immune responses or biological repairing mechanisms. Epidemiology investigates large scale phenomena based on statistical analysis. Statistics can pick out an effect, its significance level and even suggest some causes of it on a population level; however, only laboratory experiments on animal models will give the ultimate cause-effect evidence and dose-response relationships of organisms exposure to EMF. Unfortunately, animal studies are costly, time consuming and, in addition, ethical and legal constraints limit their implementation²¹.

The present report deals with laboratory experiments on an animal model. Most of past research with laboratory animals under ELF MF was concerned to carcinogenic processes and conducted mainly on rats and mice. Here, we are considering a different problem: the influence of ELF MF on animal ontogenetic development. In the past, most of laboratory experiments of our interest studied effects of exposures on reproductive performances: fetal viability, number of litters, litter size, sex ratio, etc. of rodents^{22, 23, 24}. In the course of these studies, some researchers noted skeletal malformations in fetus of exposed females^{25, 26} and (interesting for the present work) Zusman *et al.*²⁷ observed a delayed embryonic maturation in rats.

Other researchers experimented effects of ELF MF on avian eggs. Overall, these investigations revealed an augment of field-dependent malformations in exposed chicken embryos. In year 1982, Delgado *et al.*⁷ published results of a laboratory research in which exposure of chicken eggs to a weak ELF MF increased the number of malformations in chicks. Successively, Delgado's research group and other independent groups replicated the experiment with significant confirmations^{8, 28, 29, 30, 31, 32}; though, some other experiments did not confirm Delgado's findings^{33, 34, 35}. Contrasting results were obtained also among a series of coordinated experiments (Henhouse Project) performed in six laboratories in different countries to check Delgado's results³⁶. Lastly, a well conducted series of five replicable (and replicated) experiments coordinated by Farrel *et al.*³⁷ concluded the controversy in favour of Delgado. In these experiments, 2500 chicken embryos were exposed to an oscillating magnetic field of 1 μ T and exhibited a significant increase of abnormalities.

During the prolonged dispute on malformations of chicken embryos, some researchers highlighted a 'secondary effect' of weak ELF MF exposures: an alteration of ontogenetic developmental rate. Ubeda *et al.*⁸ noted in his experiments that two magnetic fields of the same frequency (100 Hz) and different flux densities (1 μ T and 13.9 μ T) brought about different chicken eggs developmental rates. Specifically, the strongest field caused the slower development. In another series of experiments, it was also reported that exposure to 50 Hz and 10 mT magnetic field can modify the effects of egg exposures to genotoxic agents^{38, 39}. Specifically, when ELF MF was administrated before the genotoxic agents the number of malformed eggs diminished, while the opposite result was obtained when they were administrated after these agents. These researches anticipated those already cited of Harris *et al.*¹⁷ and Takashima *et al.*¹⁸. We cannot close this short survey of EMF-chicken experiments without citing an article by Youbicier-Simo *et al.*⁴⁰ that suggested our first experiment of bio-electromagnetism. In this article, the authors described a research in which chicken embryos were exposed to the electromagnetic field emitted from a television cathode ray tube (CRT) and suffered significant malformations.

Relatively few researches were published on the developmental consequences of ELF MF exposures of non-mammalian or non-avian animal models and about all (of them) dealt with embryonic development. Experiments with zebrafish embryos⁴¹ and *Drosophila*^{42, 43} did not show teratogenic effects of the exposures and with medaka fish (*Oryzias latipes*)⁴⁴ and sea urchin eggs⁴⁵ revealed developmental delays without abnormalities.

Few works can be found in scientific literature referring to *X. laevis* (Daudin) as animal model for experiments of exposures to electric, magnetic or electromagnetic fields⁴⁶⁻⁵⁰, yet this amphibian has become a very common laboratory animal in the last decades. After publication of the Nieuwkoop and Faber⁵¹ 'Normal Tables of *Xenopus*

laevis' in which animal rearing and manipulation in laboratory were described with great detail, the amphibian was the model for a steadily increasing number of laboratory experiments in embryology, histology, and cellular biology. At our knowledge, the first experiment performed in vivo with *X. laevis* as target of ELF MF was that of the first author of this report⁴⁸. Although results obtained using amphibians are not useful for predicting the effects of EMF exposures on human beings, they can be very useful to discover biological mechanisms of action of these fields. As a matter of fact, a relatively large number of tadpoles (larvae of amphibians) can be reared easily in limited volumes to support reliable statistics and inspected without significant stress of manipulation.

Following the article by Youbicier-Simo *et al.*⁴⁰, Severini *et al.*⁴⁸ exposed an aquarium holding 110 *X. laevis* tadpoles to an on TV screen. The exposure to the EMF emitted from the TV set lasted about two months during which tadpoles developed from an early larval stage (stage 39 according to the Nieuwkoop and Faber classification) to metamorphosis beginning (stage 58). Results of three replicated experiments showed: a) a significant delayed metamorphosis of about 5 days ($p < 0.001$) of exposed tadpoles with respect to their controls and b) absence of teratological effects and significant mortality in exposed animals.

These results were in agreement with those of Cameron *et al.*⁴⁴ and Zimmerman *et al.*⁴⁵ and were confirmed later by Grimaldi *et al.*⁴⁹. On account that the impulsive sawtooth shape of EMF emitted from the cathode ray tube consists of a large number of harmonic components, it was not possible to ascertain which frequency-amplitude combination (or combinations) of the field caused the observed developmental delay. This was the main reason why we performed new experiments by repeating the above experiment in a large solenoid where magnetic field amplitude and frequency could be set independently. In a group of experiments, magnetic field in the solenoid was set at 50 Hz and 70 μ T (rms average value) and it caused a significant maturation delay of 2.4 days ($p < 0.001$) with respect to their controls⁵². In the present report, the experimental data of the former experiment are considered from a different point of view and re-processed to investigate the sensitivity of *X. laevis* tadpoles developmental rate to small differences of magnetic flux density.

Materials and methods

a) Animal model

The Anuran species *Xenopus laevis* (Daudin) of *laevis* subspecies used in the present research is familiar to a large number of geneticists, embryologists, and biological engineers that have adopted it as biological model. Its management in laboratory conditions is the argument of numerous specialized manuals^{51, 53, 54}.

Here, we refer to the 'Normal Tables of *X. laevis*' by Nieuwkoop and Faber. According to the 'Tables', the following animal's characteristics were applied in the present work: females are induced to mate and spawn by injections of gonadotrophic hormones; optimum of temperature for normal tadpoles development is between 20°C and 25°C; in aquariums, cohorts of tadpoles must be reared at a density not less than 0.5 litres per tadpole for avoiding competition among the animals; boiled nettle is a recommended diet for tadpoles; 57 sub-stages can be recognized before maturation, and sub-

stage 58 marks the metamorphosis beginning; tadpoles development is regular in darkness or in soft light.

b) *Experimental features*

A sexually mature pair of *X. laevis laevis* adults (bought from NASCO Biologicals and Educational Kits Production Facility, Fort Atkinson, Wisconsin, USA) were selected and induced to mate and spawn through injections of gonadotrophic hormones (Gonasi, Institute Biochimique Société Anonyme, Lugano) in the lymphatic dorsal sac. About 12 hours after the treatment, the spawn took place in two trays filled with water at 24.0 ± 0.3 °C. The spawn day was also considered as the first day of life of the newly fertilized eggs, it was labelled as day $j = 1$ and considered as first day of the experiment. After the spawn, one tray was placed into the running solenoid (see below) and the other one, as control, far from it. Two days after the birth ($j = 3$), the animals reached the sub-stage $k = 39$ which was already a larval sub-stage (according to the ‘Tables’) and became enough robust to be observed under a stereoscopic microscope (with a very soft illumination). This enabled us to form four synchronized cohorts of 35 tadpoles in sub-stage 39. Two cohorts were formed by tadpoles picked up from the exposed tray, transferred into two aquariums (E1, E2) and placed again in the running solenoid. The other two cohorts were formed by tadpoles from the control tray, transferred into two aquariums (C1, C2), placed far from the solenoid and considered as controls (fig. 1a). Every effort was paid to guarantee comparable conditions to the four cohorts according to the ‘Tables’ (including: constant water temperature at 24.0 ± 0.3 °C, heavy shading, equal alimentation, and absence of mechanical vibrations in the exposed aquariums. The unique difference between aquariums (E1, E2) and (C1, C2) was the exposure to the magnetic field.

Instead, there was a small difference of exposure between aquariums E1 and E2 because of a small anisotropy of magnetic field along the solenoid axis with respect to solenoid centre (fig. 1b). This feature depended on the perturbation of solenoid border effect caused by a small difference of current at its extremes. Frequency and magnetic

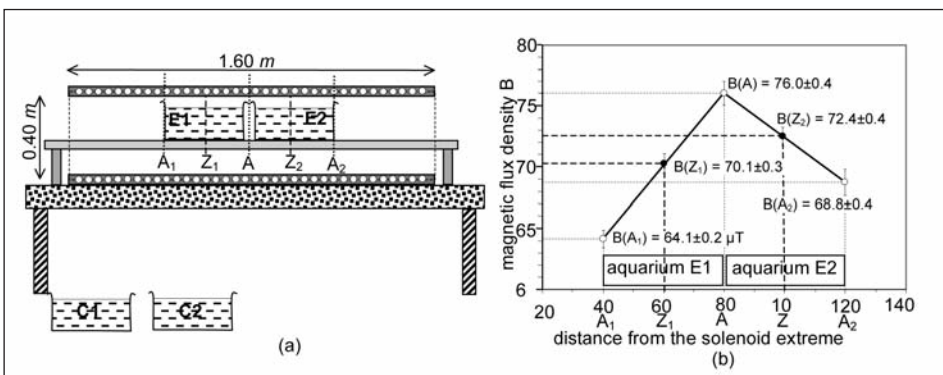

Fig. 1. (a) Synthetic representation of experimental apparatus. 1.60 m long and 0.40 m diameter solenoid and a wooden board in it. The board supported two aquariums E1 and E2 and was supported on a table. A indicates solenoid centre, A₁ and A₂ indicate aquarium’s E1 and E2 walls, Z₁ and Z₂ the aquarium’s centers, and C1 and C2 two control aquariums. (b) Mean values and standard deviations (error bars) of magnetic flux density along solenoid axis B(A₁), B(A), and B(A₂) measured at the points A₁, A, and A₂ and of magnetic flux density B(Z₁) and B(Z₂) calculated at points Z₁ and Z₂, respectively

flux density inside the solenoid and in control aquariums were checked weekly by an EFA-3 (Wandel & Goltermann Inc. USA; now EFA 300, NARDA Safety Test Solution, NY11788 USA) measuring device.

On day $j = 5$, with tadpoles at mean sub-stage $k = 45$, cohorts feeding was initiated and on day $j = 7$, with tadpoles at mean sub-stage $k = 48$, inspections of tadpoles by a stereoscopic microscope commenced. This sub-stage is characterized by the first appearance of hind limb buds on tadpole's body. From this stage on, the buds will grow and change their shape until the formation of fully developed limbs at sub-stage $k = 58$. Starting from day $j = 11$, the inspection of all the tadpoles in the four cohorts was performed daily until the last tadpole got to sub-stage 58. After their first arrival to sub-stage 58, tadpoles were no more inspected and attributed to this sub-stage even if they passed to successive sub-stages.

The described experiment was replicated three times with cohorts of tadpoles obtained from three different pairs of adults.

c) Data organization

Let us label the three replicated experiments (or 'litters') with the letter i ($i = 1, 2, 3$), the tadpole stages with k ($k = 48, 49, \dots, 58$), the cohorts in each experiment (or 'treatment') with $h = 1, 2, 3, 4$, respectively cohorts (in) E1, E2, C1, C2, and the time (days) of the experiment so as the tadpole's age with j ($j = 1, 2, 3, \dots, J$) where J_i is the last day of the i -th experiment. In the course of the three experiments, we took the number

$$N_{ih}(j,k)$$

of tadpoles of the h -th cohort that, in the i -th experiment, were attributed to the k -th stage in the j -th day and the daily maturation frequencies (or fluxes) of tadpoles in the sub-stage 58, $F_{ih}(j)$.

The weighted mean of daily frequencies of cohort tadpoles in all possible sub-stages gives the daily mean stages of the cohort itself. Then, algorithm

$$K_{ih}(j) = \frac{\sum_{k=48}^{58} k \cdot N_{ih}(j,k)}{\sum_{k=48}^{58} N_{ih}(j,k)}$$

gives the mean stage of tadpoles in the h -th aquarium of i -th experiment as a function of time j . To compare the developmental rate of cohorts grown under the weaker field (in aquarium E1) to that of cohorts grown under the stronger one (in aquarium E2) - which is the task of the present work - it is sufficient to put respectively $h = 1$ and $h = 2$ and to calculate the means

$$K_1(j) = \frac{1}{3} \cdot \sum_{i=1}^3 K_{i1}(j) \quad , \quad K_2(j) = \frac{1}{3} \cdot \sum_{i=1}^3 K_{i2}(j)$$

Results

The data of magnetic flux density $B(A_1)$, $B(A)$, and $B(A_2)$ reported in fig. 2 result from averages of the weekly measurements made in the solenoid's centre (A) and near the walls A1 and A2 of the two aquariums E1 and E2 during the three experiments. Instead, the two values of magnetic flux density in the centres of exposed aquariums $B(Z_1)$ and $B(Z_2)$ are calculated means. According to Student's t statistics, $B(Z_1)$ and $B(Z_2)$ are significantly different ($p < 0.001$). Fig. 2 shows that the ranges of magnetic induction in E1 and E2 were in part overlapped, however, on account that tadpoles were in continuous movement, it is straightforward to assume that cohorts reared in aquariums E1 developed under a magnetic field in the range $63.9 \mu\text{T} < B < 76.4 \mu\text{T}$ and cohorts in aquariums E2 in the range $68.4 \mu\text{T} < B < 76.4 \mu\text{T}$ and to hypothesise that the cohorts in E1 experienced a magnetic field slightly weaker than those in E2.

In order to verify this hypothesis (and to have a comparison with the controls), the mean maturation times of tadpoles in the four aquariums E1, E2, C1, C2 are processed by the two factors analysis of variance (ANOVA) applied to the observed maturation frequencies $F_{in}(j)$. Table 1 summarizes the data for the analysis; with the two factors being: litter (i) and treatment (h). It suggests that mean maturation times and their standard deviations were very different in the three litters ($i = 1, 2, 3$), different in exposed and control cohorts ($h = 1, 2$ vs $h = 3, 4$), slightly different in the exposed cohorts ($h = 1, 2$), quite equal in the control cohorts ($h = 3, 4$).

Table 2 presents the main results of the two factors ANOVA applied to the data of Table 1. It shows that, even if there was a significant influence of the different litters on their mean maturation times, there was also an highly significant effect of the exposures on them.

The above ANOVA doesn't specify if one or more treatments influenced the mean maturation times, nor which treatment(s) caused them. To solve this problem, the statistical procedure of the so called Bonferroni correction can be applied, whose results are reported in Table 3. It compares the differences of the mean maturation times (mean delays) corresponding to all couples of treatments and evaluates their degree of confi-

Table 1 - Summary of the observed maturation frequencies as mean maturation times in four cohorts (treatment $h = 1,2,3,4$) by three experiments (litter $i = 1, 2, 3$) ready for the two ways analysis of variance (ANOVA)

Litter i	Treatment h	Mean maturation time (days)	Standard deviation (days)	Matured tadpoles
1	1	35.5	6.5	35
	2	35.2	7.5	35
	3	32.8	4.6	34
	4	32.3	3.9	35
2	1	31.3	3.2	35
	2	33.2	5.1	35
	3	31.5	2.8	35
	4	30.2	2.9	35
3	1	35.7	7.0	35
	2	42.0	10.5	32
	3	35.9	8.2	35
	4	35.3	7.2	35

Table 2 - Two factors analysis of variance (ANOVA) of the observed maturation frequencies $F_{in}(j)$ to check the significance of mean tadpole's maturation times differences caused from the two factors: litter and treatment. Last row shows that interaction between litter and treatment was not significant.

Factors	Critic F value	Error probability p
Litter ($i = 1,2,3$)	29.5	<0.001
Treatment ($h = 1,2,3,4$)	8.9	<0.001
Litter treatment	1.9	0.07

Table 3 - Multiple comparisons among treatments according to the Bonferroni correction

Treatment	Treatment	Mean delay (days)	Standard deviation (days)	Error probability p
$h = 1$	$h = 2$	-2.5	0.9	<0.05
$h = 1$	$h = 3$	0.8	0.9	1.00
$h = 1$	$h = 4$	1.6	0.9	0.40
$h = 2$	$h = 3$	3.2	0.9	<0.001
$h = 2$	$h = 4$	4.1	0.9	<0.001
$h = 3$	$h = 4$	0.8	0.9	1.00

dence. The results show that: a) the mean maturation delays of the cohorts exposed to the stronger magnetic field with respect to the two controls (treatments $h = 2, 3$ and $h = 2, 4$, delays 3.2 and 4.1 days, respectively) are highly significant ($p < 0.001$); b) the mean maturation delays of the cohorts exposed to the weaker magnetic field with respect to the two controls (treatments $h = 1, 3$ and $h = 1, 4$) are not significant; c) the mean maturation delay of 2.5 days of the cohorts exposed to the stronger field with respect to the cohorts exposed to the weaker one (treatments $h = 1, 2$) is significant ($p < 0.05$); d) the difference in mean maturation times of control cohorts is not significant.

The result that shows a significant delay of mean maturation time of cohorts exposed to the stronger magnetic field with respect to that exposed to the weaker one solicits the analysis of the development of cohorts grown in aquariums E1 and E2 before their arrival to sub-stage 58 to ascertain when the observed delay was commenced. For this purpose, the daily trends of mean cohort stages $K_1(j)$ and $K_2(j)$ are compared. Table 4 reports the values of $K_1(j)$ and $K_2(j)$ calculated by the observed data $N_{1i}(j,k)$ and $N_{2i}(j,k)$ according to the above definition. It is evident that the average stages of cohorts under the stronger field were always in retard with respect to those under the weaker one. Fig. 2 shows the plots of $K_1(j)$ and $K_2(j)$ with their regression (straight) lines and regression equations that are accompanied by very high values of the regression coefficients. In addition, application of Student's t statistics for comparison of two regression lines to the data of Table 4 guarantees that the slopes of the two lines:

$$\gamma_1 = 0.4759 \text{ sub-stages/day}, \quad \gamma_2 = 0.4576 \text{ sub-stages/day}$$

are statistically significantly different ($t = 2.106$, $DF = 22$, $p < 0.05$). This result shows that action of the two slightly different magnetic fields in slowing down the developmental rate of exposed cohorts was constantly different and that it started very early in larval sub-stages (probably in sub-stage 50).

Table 4 - Daily mean developmental stages of tadpoles cohorts exposed to the weaker magnetic field $K_1(j)$ and to the stronger one $K_2(j)$ in the solenoid

Day after fertilization (j)	Under weaker field $63.9 \mu\text{T} < B < 76.4 \mu\text{T}$ cohort mean stage $K_1(j)$	Under stronger field $68.4 \mu\text{T} < B < 76.4 \mu\text{T}$ cohort mean stage $K_2(j)$
9	49.55	49.54
10	49.96	49.90
11	50.36	50.27
12	50.80	50.69
13	51.25	51.10
14	51.85	51.65
15	52.26	52.25
16	52.92	52.63
17	53.30	53.07
18	53.87	53.60
19	54.23	54.03
20	54.60	54.41
21	55.14	54.87

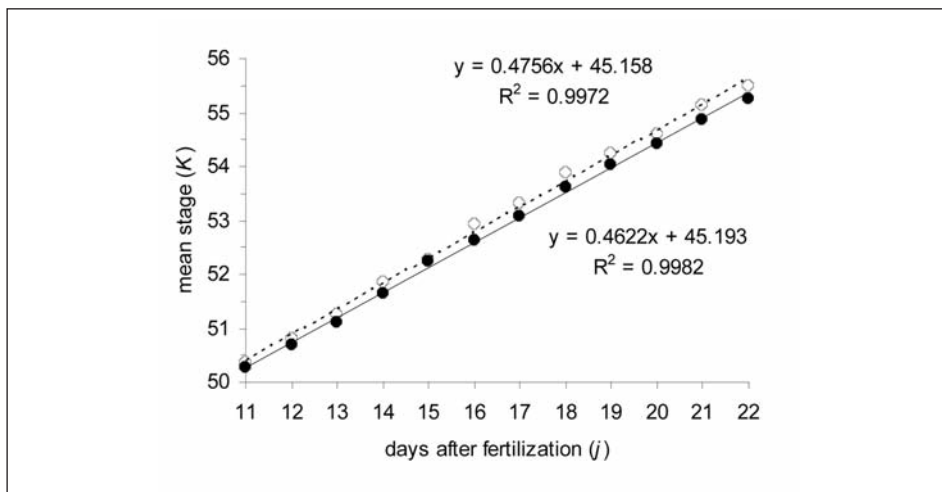

Fig. 2. Linear regressions of larval mean sub-stages of exposed *X. laevis* tadpoles. Empty circles indicate mean sub-stages $K_1(j)$ of tadpoles grown under the weaker magnetic field and the full circles mean sub-stages $K_2(j)$ of tadpoles grown under the stronger one

Discussion and conclusions

First of all we want to stress the sensitivity of *X. laevis* tadpoles as biological model for investigating dose-effect responses to weak ELF MF exposures. Experimental method applied to quantify animal’s developmental rate resulted also very accurate in revealing a minimum though statistically significant different developmental rate caused from a minimum though significant exposures.

One of the main advantages to experiment with *X. laevis* tadpoles cohorts was the possibility to rear a relatively large number of specimens in a relatively small volume, and the other one the extremely detailed sub-division of animal's larval stage in 24 sub-stages according to Nieuwkoop and Faber's⁵¹ 'Normal Tables'. Thanks to these two features, we got a large number of experimental data for statistical analysis, and it is this large number of data (that can easily augmented) that justifies the sensitivity of the applied experimental method.

It is worth noting that the present work does not deal with an usual stress-control experiment. Comparison of developmental rates of exposed tadpoles in aquariums E1 and E2 with controls C1 and C2 were already discussed elsewhere³². Here, we are confronting a more subtle question: how and if it is possible to quantify the effects of small variations of ELF MF exposures on whole organisms in vivo. The results of this report show that it is possible.

The analysis of variance of maturation frequencies $F_{ih}(j)$ shows that tadpoles that grew in aquarium E2 under the stronger field matured with a significant mean delay of 2.5 days with respect to tadpoles that grew in aquarium E1 under the weaker one (Table 3, first row). This delay was clearly the result of a small but constant (significant) difference in tadpole's developmental rates (Figure 2) caused by exposures to two slightly different ranges of ELF magnetic flux densities ($68.4 \mu\text{T} < B < 76.4$, $63.9 \mu\text{T} < B < 76.4 \mu\text{T}$). The ANOVA shows not only that in our experiments there was a maturation delay between cohorts exposed to two different MFs, but also a maturation delay between the exposed and unexposed cohorts (Table 3, rows 2, 3, 4, 5). It also shows that whereas the mean maturation delays of tadpoles that were exposed to the weaker magnetic field with respect to control tadpoles in aquariums C1 and C2 resulted small (0.8 days and 1.6 days, respectively) and not significant (Table 3, rows 2, 3), the mean maturation delays of tadpoles that were exposed to the stronger magnetic field with respect to the same controls resulted large (3.2 days and 4.1 days) and highly significant (Table 3, rows 4, 5). Evidently, it was the stronger field that brought about the major maturation delay both with respect to controls and to cohorts under the weaker field. This result might suggest the existence of a threshold around $70 \mu\text{T}$ magnetic flux density in promoting the observed slow down of tadpoles developmental rate.

Scientific literature reports a plethora of different and very often contrasting results about biological effects of ELF MF exposures on living organisms. For example, experiments like ours performed on different animal models brought about: a) malformations without developmental delays^{7, 32, 37}, b) malformations with delays⁸, c) delays without malformations^{44, 45}, d) no malformations and no delays⁴¹⁻⁴³. It is clear that different animals reacted differently to similar electromagnetic stimuli. Moreover, even equal exposures applied to the same animal model gave different outcomes (see the results with chicken embryos, for example) that probably depended on particular ontogenetic stage of exposure. The researches about action of electromagnetic fields on cellular cycle can be summarized in three main groups that take account of: a) inhibition of formation and secretion of melatonin⁵⁵⁻⁶⁰, b) alteration of the cellular cycle and weakening of the stringency of cell cycle checkpoints^{16-18, 61-70}, c) modification of transport mechanisms through cell membranes^{19, 71-74}.

The heterogeneity of results obtained from ELF MF exposure of different organisms is not surprising if it is considered that the most likely effect of the exposure on biological molecules is that suggested by Blank¹⁹. According to the Blank's hypothesis, ELF MF exposure can bring about charge transfers in proteins that can trigger their confor-

mational change. Such a change is able *in principle* to alter different inter- and intra-cellular activation and/or inactivation mechanisms. These mechanisms are different in different animal models and they differ according to developmental degree in the same animal. At present, we'd suggest to deepen the experimental research on the main animal models (drosophila, frog, chick, mice, etc.) and to individuate the key developmental passages affected by ELF MF before proceeding to some generalization of disturbs of these fields *in vivo*.

As to *X. laevis*, it is well known that thyroid hormone controls animal's pro-metamorphosis and activates different pathways in different larval cell types via different inter- and intra-cellular signaling⁵¹. According to the results of our experiment and to Blank's hypothesis, it is presumable that tadpoles exposure in solenoid affected the spatial structure of the hormone or of some molecule controlling its release (e.g. melatonin). Of course, this doesn't exclude a possible action of ELF MF on the different signaling systems that activate and drive the cell cycles (e.g. cyclins) of different larval tissues in one (or more) larval stage(s).

Acknowledgements

We are indebted to prof. A. Congiu and I. Bozzoni of 'La Sapienza' University (Roma) and dr. Livio Giuliani of ISPSEL for their support. We also thank dr. R. Alilla, dr. S. Pesolillo, dr. G. Tarantino, mr. M. Loy, and mr. C. Romano for their help in performing the experiments, and dr. Olivia Severini for reviewing the English manuscript.

This research was funded by ISPESL fund B129/DIPIA/2003.

References

1. Wertheimer N, Lepeur E. Electrical wiring configurations and childhood cancer. *Am J Epidemiol* 1979; 109: 273-84.
2. Draper G, Vincent T, Kroll ME, *et al.* Childhood cancer in relation to distance from high voltage power lines in England and Wales: a case-control study. *BMJ* 2005; 330.
3. Albohm A, Cardis E, Green A, *et al.* Review of the epidemiologic literature on EMF and health. *Environ Health Perspect* 2001; 109: 911-33.
4. Marino A, Berger TJ, Mitchell JT, *et al.* Electric field effects in selected biologic systems. *Ann NY Acad Sci* 1974; 238: 433-6.
5. Kaczmarek LK, Adey WR. Weak electric gradients change ionic and transmitter fluxes in cortex. *Brain Res* 1974; 66: 537-40.
6. Blackman CF, Benane SG, Kinney LS, *et al.* Effects of ELF fields on calcium-ion efflux from brain tissue *in vitro*. *Rad Res* 1982; 92: 510-20.
7. Delgado JR, Leal J, Moneagudo JL, *et al.* Embryological changes induced by weak ELF EMF. *J Anat* 1982; 134: 533-51.
8. Ubeda A, Leal J, Trillo M, *et al.* Pulse shape of MF influences chick embryogenesis. *J Anat* 1983; 137: 513-36.
9. Blackman CF, Benane SG, Rabinowitz JR, *et al.* A role for the magnetic field in the radiation-induced efflux of calcium ions from brain tissue *in vitro*. *Bioelectromagnetics* 1985; 6: 327-37.
10. Liboff AR. Geomagnetic cyclotron resonance in living cells. *J Biol Phys* 1985; 13: 99-102.
11. Liboff AR, Smith SD, McLeod BR. Experimental evidence for ion cyclotron resonance mediation of membrane transport. In Blank M, Findl E. Mechanistic approaches to interactions of electric and electromagnetic fields with living systems. New York and London: Plenum Press 1987; 109-32.
12. Smith SD, McLeod BR, Liboff AR, *et al.* Calcium cyclotron resonance and diatom mobility. *Bioelectromagnetics* 1987; 8: 215-27.

13. Zhadin MN, Novikov VV, Barnes FS, *et al.* Combined action of static and alternating magnetic fields on ionic current in aqueous glutamic acid solution. *Bioelectromagnetics* 1998; 19: 41-5.
14. Adair RK. Constraints on biological effects of weak extremely-low-frequency electromagnetic fields. *Phys Rev* 1991; A 43: 1039-48.
15. Reiter R. Melatonin in the context of the reported bioeffects of environmental electromagnetic fields. *Bioelectrochem Bioenerg* 1998; 47: 135-42.
16. Cridland NA, Haylock RE, Saundes RD. 50 Hz magnetic field exposure alters onset of s-phase in normal human fibroblasts. *Bioelectromagnetics* 1999; 20: 446-52.
17. Harris PA, Lamb J, Heaton B, *et al.* Possible attenuation of the G2 DNA damage cell cycle checkpoint in HeLa cells by extremely low frequency (ELF) electromagnetic fields. *Cancer Cell International* 2002; 2: 3.
18. Takashima Y, Ikehata M, Miyakoshi J, *et al.* Inhibition of UV-induced G1 arrest by exposure to 50 Hz magnetic fields in repair-proficient and -deficient yeast strains. *Int J Rad Biol* 2003; 79: 919-24.
19. Blank M. Protein and DNA reactions stimulated by electromagnetic fields. *Electromagn Biol Med* 2008; 27: 3-23.
20. Valberg PA, Kavet R, Rafferty CN. Can low-level 60-Hz electric and magnetic fields cause biological effects? *Rad Res* 1997; 148: 2-21.
21. Dolan K. *Laboratory animal law*. Oxford: Blackwell science, 2000.
22. Ryan BM, Symanski RR, Pomeranz LE, *et al.* Multigeneration reproductive toxicity assessment of 60 Hz magnetic fields using a continuous breeding protocol in rats. *Teratology* 1999; 59: 156-62.
23. Al-Akhras MA, Elbetieha A, Hasan MK, *et al.* Effects of extremely low frequency magnetic field on fertility of adult male and female rats. *Bioelectromagnetics* 2001; 22: 340-4.
24. Elbetieha A, Al-Akhras MA, Darmani H. Long term exposure of male and female mice to 50 Hz magnetic field: effects on fertility. *Bioelectromagnetics* 2002; 23: 168-72.
25. Mevissen M, Buntenkotter S, Löscher W. Effects of static and time varying (50 Hz) magnetic fields on reproduction and fetal development in rats. *Teratology* 1994; 50: 229-37.
26. Ryan BM, Polen M, Gauger JR, *et al.* Evaluation of the developmental toxicity of 60 Hz magnetic fields and harmonic frequencies in Sprague-Dawley rats. *Radiat Res* 2000; 153: 637-41.
27. Zusman I, Yaffe P, Pinus H, *et al.* Effects of pulsing electromagnetic fields on the prenatal and postnatal development in mice and rats: in vivo and in vitro studies. *Teratology* 1990; 42: 157-70.
28. Leal J, Shamsaifar K, Trillo MA, *et al.* Embryonic development and weak changes of the geomagnetic field. *J Bioelectr* 1989; 7: 141-153.
29. Juutilainen J, Saali K. Development of chick embryos in 1 to 1 kHz MF. *Radiat Env Biophys* 1986; 25: 135-140.
30. Martin AH. Development of chicken embryos following exposure to 60 Hz MF with differing waveforms. *Bioelectromagnetics* 1992; 13: 223-30.
31. Koch W, Koch B, Martin A, *et al.* Examination of the development of chicken embryos following exposure to magnetic fields. *Comp Biochem Physiol* 1993; 105: 615-24.
32. Terol FF, Panchon A. Exposure of domestic quail embryos to extremely low frequency magnetic fields. *Int J Radiat Biol* 1995; 68: 321-30.
33. Maffeo S, Miller M, Carstensen E. Lack of effect of weak low-frequency EMF on chick embryogenesis. *J Anatomy* 1984; 139: 613-8.
34. Sandstrom M, Mild KH, Lovtrup S. Effects of weak-pulsed MF on chick embryogenesis. In: Knaue B, Widebäck PG. *Work with display units*. Amsterdam, Elsevier Sci Publ, 1986, 135-40.
35. Siskin BF, Fowler I, Mayaud C, *et al.* Pulsed EMF and normal chick development. *J Bioelectricity* 1986; 5: 25-34.
36. Berman E, Chacon L, House D, *et al.* Development of chicken embryos in a pulsed magnetic field. *Bioelectromagnetics* 1990; 11: 169-87.
37. Farrel JM, Litovitz TL, Penafiel M, *et al.* The effect of pulsed and sinusoidal MF on the morphology of developing chick embryos. *Bioelectromagnetics* 1997; 18: 431-8.
38. Pafkova H, Jerabek J. Interaction of MF 50 Hz, 10 mT with high dose of X-rays: evaluation of embryotoxicity in chick embryos. *Rev Environ Health* 1994; 10: 235-41.
39. Pafkova H, Jerabek J, Tejnorova I, *et al.* Developmental effects of magnetic field (50 Hz) in combination with ionizing radiation and chemical teratogens. *Toxicol Lett* 1996; 88: 313-6.
40. Youbicier-Simo B, Boudard F, Cabaner C, *et al.* Biological effects of continuous exposure of embryos and young chickens to EMF emitted by VDU. *Bioelectromagnetics* 1997; 18: 514-23.

41. Skauli KS, Reitan JB, Walther BT. Hatching in zebrafish (*Danio rerio*) embryos exposed to a 50 Hz magnetic field. *Bioelectromagnetics* 2000; 21: 407-10.
42. Nguyen P, Bourmias-Vardiabasis N, Haggren W, *et al.* Exposure of *Drosophila melanogaster* embryonic cell cultures to 60 Hz sinusoidal magnetic fields: assessment of potential teratogenic effects. *Teratology* 1995; 51: 273-7.
43. Graham JH, Fletcher D, Tigue J, *et al.* Growth and developmental stability of *Drosophila melanogaster* in low frequency magnetic fields. *Bioelectromagnetics* 2000; 21: 465-72.
44. Cameron IL, Hunter KE, Winters WD. Retardation of embryogenesis by extremely low frequency 60 Hz electromagnetic fields. *Physiol Chem Phys Med NMR* 1985; 17: 135-8.
45. Zimmerman S, Zimmerman AM, Winters WD, *et al.* Influence of 60 Hz magnetic fields on Sea Urchin development. *Bioelectromagnetics* 1990; 11: 37-45.
46. Dover PJ, McCaig CD. Enhanced development of striated myofibrils in *xenopus* myoblasts cultured in an applied electric field. *Q J Exp Physiol* 1989; 74: 545-8.
47. Miura M, Okada J. Non-thermal vasodilatation by radio-frequency burst-type electromagnetic field radiation in the frog. *J Physiol* 1991; 435: 257-73.
48. Severini M, Dattilo AM, De Gaetano A. Sublethal effect of a weak intermittent magnetic field on the development of *Xenopus laevis* (Daudin) tadpoles. *Int J Biometeorol* 2003; 48: 91-7.
49. Grimaldi S, Lisi A, Reiti S, *et al.* Influence of 50-Hz electromagnetic field on anurian (*Xenopus laevis*) metamorphosis. *Scientific World Journal* 2004; 4-2: 41-7.
50. Chemeris NK, Gapeyev AB, Sirota NP, *et al.* DNA damage in frog erythrocytes after in vitro exposure to a high peak-power pulsed electromagnetic field. *Mutat Res* 2004; 558(1-2): 27-34.
51. Nieuwkoop P, Faber J. Normal table of *Xenopus laevis*. Amsterdam, North Holland, 1956.
52. Severini M, Bosco L, Alilla R, *et al.* Metamorphosis delay in *Xenopus laevis* (Daudin) tadpoles exposed to a 50 Hz weak magnetic field. *Int J Radiat Biol* 2010; 86: 37-46.
53. Roberts R. *Experimental Embryology*. Minneapolis, Burgess Publ Co, 1949.
54. Deuchar EM. *Xenopus: the South African clawed frog*. London, John Wiley and Sons, 1975.
55. Marino AA. *Modern bioelectricity*. CRC Press, 1988.
56. Hing-Sing Y, Reiter RJ. Melatonin: biosynthesis, physiological effects, and clinical applications. CRC Press, 1992, 311-48.
57. Liburdy RP, Sloma TR, Sokolic R, *et al.* ELF magnetic fields, breast cancer, and melatonin: 60 Hz fields block melatonin's oncostatic action on ER+ breast cancer cell proliferation. *J Pineal Res* 1993; 14: 89-97.
58. Harland JD, Liburdy RP. Environmental magnetic fields inhibit the antiproliferative action of tamoxifen and melatonin in a human breast cancer cell line. *Bioelectromagnetics* 1997; 18: 555-62.
59. Blackman CF, Benane SG, House DE. The influence of 1.2 microT, 60 Hz magnetic fields on melatonin- and tamoxifen-induced inhibition of MCF-7 cell growth. *Bioelectromagnetics* 2001; 22: 122-8.
60. Ishido M, Nitta H, Kabuto M. Magnetic fields (MF) of 50 Hz at 1.2 microT as well as 100 microT cause uncoupling of inhibitory pathways of adenylyl cyclase mediated by melatonin 1a receptor in MF-sensitive MCF-7 cells. *Carcinogenesis* 2001; 22: 1043-48.
61. Goodman EM, Greenebaum B, Marron MT. Effects of extremely low frequency electromagnetic fields on *Physarum polycephalum*. *Rad Res* 1976; 66: 531.
62. Hintenlang DE. Synergistic effects of ionising radiation and 60 Hz magnetic fields. *Bioelectromagnetics* 1993; 14: 545-51.
63. Sienkiewicz ZJ, Cridland NA, Kowalczuk CI, *et al.* Biological effects of electromagnetic fields and radiation. In Stone WR, ed. *Review of radio science 1990-1992*. New York: Oxford University Press, 1993, 737-70.
64. Cridland NA. Effects of power frequency EMF exposures at the cellular level. *Rad Prot Dosymetry* 1997; 72: 279-90.
65. Rapley BI, Rowland RE, Page WH, *et al.* Influence of extremely low frequency magnetic fields on chromosomes and the mitotic cycle in *Vicia faba* L, the broad bean. *Bioelectromagnetics* 1998; 19: 152-61.
66. Markkanen A, Juutilainen J, Lang S, *et al.* Effects of 50 Hz magnetic field on cell cycle kinetics and the colony forming ability of budding yeast exposed to ultraviolet radiation. *Bioelectromagnetics* 2001; 22: 345-50.

67. Huang L, Dong L, Chen Y, *et al.* Effects of sinusoidal 50 Hz magnetic field on viability, cell cycle and apoptosis of HL-60 cells. *European Phys J Appl Phys* 2006; 35: 217-21.
68. Levin M, Ernst SG. Applied AC and DC magnetic fields cause alterations in the mitotic cycle of early sea urchin embryos. *Bioelectromagnetics* 1995; 16: 231-40.
69. Lange S, Viergutz T, Simkó M. Modifications in cell cycle kinetics and in expression of G₁ phase-regulating proteins in human amniotic cells after exposure to electromagnetic fields and ionizing radiation. *Cell Prolif* 2004; 37: 337-49.
70. Tian F, Nakahara T, Yoshida M, *et al.* Exposure to power frequency magnetic fields suppresses x-ray-induced apoptosis transiently in Ku80-deficient xrs5 cells. *Biochem Biophys Res Commun* 2002; 292: 355-61.
71. Liboff AR. Cyclotron resonance in membrane transport. In Chiabrera A, Nicolini C, Schwan HP. *Interaction between electromagnetic fields and cells*. New York: Plenum Press, 1985, A97: 281.
72. Santini MT, Cametti C, Paradisi S, *et al.* A 50 Hz sinusoidal magnetic field induces changes in the membrane electrical properties of K562 leukaemic cells. *Bioelectrochem Bioenerg* 1995; 36: 39-45.
73. Ikehara T, Yamaguchi H, Miyamoto H. Effects of electromagnetic fields on membrane ion transport of cultured cells. *J Med Invest* 1998; 45: 47-56.
74. Ikehara T, Yamaguchi H, Hosokawa K, *et al.* Effects of ELF magnetic field on membrane protein structure of living HeLa cells studied by Fourier transform infrared spectroscopy. *Bioelectromagnetics* 2003; 24: 457-64.

Is cognitive function affected by mobile phone radiation exposure?

Adamantia F. Fragopoulou, Lukas H. Margaritis

Electromagnetic Biology Laboratory, Department of Cell Biology and Biophysics, Faculty of Biology, Athens University, Greece

Abstract

Behavioral tasks, including the Morris water maze (MWM), radial arm maze and object recognition task, have been extensively used to test cognitive impairment following exposure of rodents to mobile phone (MP) radiation on various frequencies and specific absorption rate (SAR) values. Exposed animals in most of the cases revealed defects in their working memory possibly due to cholinergic pathway distraction. The only experiment on mice at very low SAR did not show statistically significant deficits by 8-arm maze, but our own data in mice exposed to GSM 900 MHz radiation, revealed memory lesions on MWM task; exposed mice had difficulties in memory consolidation and/or retrieval of the stored information. Lastly, a number of studies have been applied to volunteers showing variable results depending on the experimental setup, revealing memory improvement or deficits following MP exposure.

The recorded data from the literature are generally favouring the conclusion that EMF is affecting memory function although a more rigorous and reproducible exposure system has to be adopted in relation to the recently criticized importance of SAR.

***Key words:* electromagnetic fields, Morris water maze, spatial memory, cognition**

Address: Lukas H. Margaritis: B.Sc., Ph.D., Professor of Cell Biology and Radiobiology, Dept. of Cell Biology and Biophysics, Faculty of Biology, Athens University, Panepistimiopolis, Ilisia, 15701, Athens, Greece - Tel.: 0030-210 7274542, Fax: 0030-210 7274742 - E-mail: lmargar@biol.uoa.gr

This work has been supported by the Special Account for Research Grants of the National and Kapodistrian University of Athens.

A.F. Fragopoulou is a scholarship recipient of the Hellenic State Scholarship Foundation – “N.D. Xrysovergis” Bequest (PhD fellowship).

Note added in proofs:

A number of studies have appeared after the submission of the manuscript, dealing with EMFs and cognitive memory function. It is worth mentioning that a positive effect was found on transgenic mice for Alzheimer’s disease following chronic exposure to MP radiation as reported by Arendash GW, Sanchez-Ramos J, Mori T, et al. *Journal of Alzheimer’s Disease* 2010; 19: 191–210.

Introduction

The extended use of mobile phone technology throughout all social levels and all ages, starting from as low as 4 years old, has forced a large number of scientists to get involved in the investigation of the effects. The major issue is that unlike other forms of everyday radiation exposure, the use of the mobile phone and the wireless DECT phone takes place near the user's head and therefore direct or indirect effect on the brain function is highly possible. Thus, the elucidation of the cellular, molecular and behavioural effects has to be explored in depth, especially since the majority of life-time users will be the current teenagers.

The aim of this kind of research is to determine a specific absorption rate (SAR) value threshold below which no obvious effects are detected in any organism, any cell, in order to propose biologically based levels for exposing humans on a daily basis either through cell phones, or base stations or DECT wireless phones or even wi-fi routers and baby monitors.

To approach these questions, extensive research is being performed in various laboratories. Due to the still unknown mode of primary action at the molecular level, many approaches studying the effects of microwaves (MW) have been applied¹.

At the population level, studies deal with the effects by statistically correlating exposure conditions to health symptoms, as severe as brain tumors^{2,3}, or mild well being discomforts, such as headaches or fatigue⁴. There is also a report on children exposed prenatally to mobile phone radiation showing defects on behavior⁵. In humans, the studies involve mainly volunteers and have investigated possible effects on sleeping conditions and memory function⁶.

Studies on animal models involve every possible aspect of experimental approach (behavioral, molecular, biochemical, biophysical, ultrastructural, physiological). Such models used are mainly rodents and to a less degree insects. Our group has shown DNA fragmentation and induced cell death during oogenesis, along with a decrease in the offspring number in insects and a defect on osteogenesis following prenatal exposure in mice⁷⁻⁹.

Due to the fact that mobile phone use affects mainly the brain tissues, special attention has been given to the study of hippocampus, cerebellum and frontal brain function and structure on rodents (mostly rats). In general there are numerous reports on the effects of electromagnetic fields (EMF) on cognitive functions. Animal learning and memory function have been tracked using mazes, such as the Morris water maze (MWM), the radial arm maze (RAM), as well as the object recognition task (ORT) and the object location task (OLT). It is well documented that these mazes are related to the spatial environment and recognition learning and memory. Extra maze spatial cues are widely applied to facilitate learning and testing any deficits following exposure to MW. Especially RAM is being used to explain hippocampal formation and function¹⁰.

The MWM task is widely used since spatial navigation is a complex cognitive function that depends on several neural and cognitive systems for successful completion^{6,11}. Unlike the T-maze in which the animals have to make a binary decision (i.e. going left or right), in the MWM successful performance requires continuous monitoring of the animal's position in relation to extra-maze cues: a process that involves "cognitive mapping". Many reports have controversially showed impairment^{12,13}, or improvement^{14,15}.

At the cell culture level, a number of studies have been performed in order to clarify under controllable and reproducible conditions, the actual primary damage induced by

EMFs. Thus, in cultured hippocampus neurons a decrease of excitatory synaptic activity and a reduced number of excitatory synapses was detected after exposure to GSM 1800 radiation (15 min/day for 7 days) at a SAR value of 2.4 W/kg¹⁶.

In addition, a recent report has found that EMFs affect the endocytotic activity of murine melanoma cells¹⁷.

Besides MW radiation effects, a limited number of studies has used extremely low frequency (ELF) EMF (50 or 60 Hz depending on the power line) revealing memory deficits on rats¹⁸⁻²⁰, which, interestingly, become less prominent upon exposure of the animals to MW²¹. A similar study but on mice showed reversible effects on cognitive functions as revealed by 8-arm RAM²².

Given the controversial evidence existing on the occurrence or not of any effects following MW exposure, we present herein a comparative analysis of reports on cognitive effects including some of our own recently published experimental data.

Results and discussion

Several pioneer studies concerning the effects of MW on cognitive functions, that examined the short term memory of rats, are published using a 2450-MHz circular waveguide exposure system and a SAR value of 0.6 W/kg²³. These investigators demonstrated significant deficits when exposed rats were performing at the RAM and the MWM and suggested that the reported defects in the working memory of rats are possibly due to cholinergic pathway distraction. On a later report it was shown that rats exposed to the same conditions, pulsed 2450-MHz MW (500 pulses/s, average power density 2 mW/cm², average whole body SAR 1.2 W/kg), for 1 hour just before each training session in a water maze, showed a deficit in their spatial “reference” memory²⁴.

On the other hand, Cobb and collaborators²⁵, replicating the experiments by Lai²³, under the same conditions of exposure, i.e. 2450-MHz, circular polarized waveguide system (CWG), SAR value 0.6 W/kg, but with minor methodological differences, did not find any effects on memory and learning in rats. Additionally, another report that appeared at the same year by exposing rats at similar conditions, did not observe any effects with RAM (Table 1)²⁶. However, it had been reported earlier that MW affect specific cognitive aspects of behavior such as, attention, memory, learning, discrimination, time perception, which may occur even at very low SAR levels²⁷.

Also, using RAM and ORT, no evidence was found at even higher SAR values of 1-3.5 W/kg, by applying head only and not whole body exposure of rats for 45 minutes and at another frequency of 900-MHz²⁸. Cosquer and collaborators on 2005 using a 12-arm maze apparatus, bordered by 30 cm high opaque walls, observed that exposed rats behaved normally. Therefore they concluded that MW exposure under those conditions (2450-MHz, circularly polarized field – Table 1) does not alter spatial working memory, when access to spatial cues was reduced²⁹.

In a recent report, the MWM performance of male Wistar rats was affected following exposure to 50 missed calls/day for 4 weeks by a GSM (900/1800 MHz) mobile phone in vibratory mode³⁰. The phone-exposed animals had significantly (~3 times) higher mean latency to reach the target quadrant in the MWM and spent significantly (~2 times) less time in the target quadrant. Trying to understand the cellular basis of the observed behavioural deficits, Leif Salford and collaborators have reported that a 2-hr exposure of rats at GSM 915-MHz resulted in neuronal damage, 28 and 50 days later³¹. In addition,

Table 1 - Comparative studies of EMF on cognitive performance
(ND=not determined, MWM=Morris Water Maze, RAM=Radial Arm Maze)

Study	Experimental Animal	Exposure source	Frequency	SAR or density	Duration of exposure	Task	Findings
Lai <i>et al.</i> , 1994	Rats	Circular polarized generator	2450 MHz	0.6 W/kg	45' before each trial	12-arm RAM	Deficit in working memory
Wang B, Lai H, 2000	Rats	Circular polarized generator	2450 MHz	1.2 W/kg	1 h before each training	MWM	Deficit in spatial reference memory
Cobb <i>et al.</i> , 2004	Rats	Circular polarized generator	2450 MHz	0.6 W/kg	45' before each trial	12-arm RAM	No effect
Dubreuil <i>et al.</i> , 2003	Rats	RF generator Head only	GSM 900 MHz	1 W/kg 3.5 W/kg	45' before each trial	12-arm RAM ORT	No effect
Cassel <i>et al.</i> , 2004	Rats	Circular polarized generator	2450 MHz	0.6 W/kg	45' before each trial	RAM	No effect
Cosquer <i>et al.</i> , 2005	Rats	Circular polarized generator	2450 MHz	0.6 W/kg	45' before each trial	RAM reduced access to cues	No effect
Nittby <i>et al.</i> , 2008	Rats	TEM cells	GSM 900 MHz	0.6 mW/kg 60 mW/kg	2 hr/week for a year	ORT episodic-like memory test 3 weeks after exposure	Effect
Narayanan <i>et al.</i> , 2009	Rats	Mobile phone	GSM 900/1800 MHz	ND	~ 50'/day (50 missed calls/day for 4 weeks)	MWM	Spatial memory impairment
Lai, 1996 Lai <i>et al.</i> , 1998	Rats	Sinusoidal magnetic fields	60Hz	1 mT	1 hr	12-arm RAM	Effect
Jadidi <i>et al.</i> , 2007	Rats	Sinusoidal magnetic fields	50 Hz	8 mT	20'	MWM	Spatial memory impairment
Sienkiewicz <i>et al.</i> , 2000	Mice	GTEM cells far field	GSM 900 MHz	0.05 W/kg	45'/day for 10 days	8-arm RAM	No effect
Fragopoulou <i>et al.</i> , 2010	Mice	Mobile phone	GSM 900 MHz	0.41-0.98 W/kg	1 hr before each trial and between the trials	MWM	Spatial memory impairment, learning lesions

(continued)

Table 1 - continued

(ND=not determined, MWM=Morris Water Maze, RAM=Radial Arm Maze)

Study	Experimental Animal	Exposure source	Frequency	SAR or density	Duration of exposure	Task	Findings
Sienkiewicz <i>et al.</i> , 1998	Mice	Sinusoidal magnetic fields	50 Hz	7.5 μ T to 7.5 mT	45' before each trial	8-arm RAM	Reversible effects
Preece <i>et al.</i> , 1999	Humans	Local brain exposure analog phone	915 MHz	1 W power	ND	Working memory	Improved performance
Koivisto <i>et al.</i> , 2000	Humans	Local brain exposure by mobile phone	GSM 902 MHz	0.25 W mean power	On and off	Working memory	Improved performance
Edelstyn and Oldershaw, 2002	Humans 20-22 years old	Local brain exposure by mobile phone	GSM 900 MHz	1.19 W/kg	30'	Cognitive neuropsychological tests subtraction and verbal fluency	Improvement
Maier <i>et al.</i> , 2004	Humans	Local brain exposure by mobile phone	GSM 915 MHz	1.0 mW/m ²	50'	Auditory discrimination	Impairment
Besset <i>et al.</i> , 2005	Humans	Local brain exposure by mobile phone	GSM 900	ND	2 hr/day, 5 days/week for 45 days	Cognitive tasks	No effect
Russo <i>et al.</i> , 2006	Humans	Local brain exposure by mobile phone	GSM 888 MHz Modulated CW-unmodulated	1.4 W/kg	40' prior to test	Cognitive tasks	No effect
Krause <i>et al.</i> , 2006	Children	Local brain exposure by mobile phone	GSM 902 MHz	1.4 W/kg	On and off	Auditory memory task	Effects on brain oscillatory responses
Regel <i>et al.</i> , 2007	Humans	Local brain exposure by mobile phone	GSM 900 MHz	1.0 W/kg	30' prior to test	Cognitive tasks	Increased accuracy in a working memory test
Haarala <i>et al.</i> , 2007	Humans	Signal generator and dummy phone	GSM 902 MHz	1.1 W/kg	On and off	Cognitive tasks	No effects
Luria <i>et al.</i> , 2009	Humans	Local brain exposure by mobile phone	GSM Nokia 5110	0.54-1.09 W/kg	On and off	Spatial working memory	Delay on reaction time

(continua)

Table 1 - continued

(ND=not determined, MWM=Morris Water Maze, RAM=Radial Arm Maze)

Study	Experimental Animal	Exposure source	Frequency	SAR or density	Duration of exposure	Task	Findings
Wiholm <i>et al.</i> , 2009	Humans	Headset with a fixed antenna placed on the left side of the head	884 MHz	1.4 W/kg	150' prior to test at 10 p.m.	Spatial memory and learning	Symptomatic group improved their performance

Reports have been ordered according to date published, species exposed and type of radiation

the same group has reported that the blood brain barrier (BBB) has been disrupted in irradiated rats³².

Concerning the long term effects, Salford's group has shown in rats that whole body SAR values, as low as 0.6 and 60 mW/kg, significantly alter the performance during an episodic-like memory test after 55 weeks of 2-hr exposure once a week³³.

Studies on the effects of MW radiation on mice' cognitive functions are very limited. In one of them the animals were exposed within GTEM (Gigahertz Transverse Electromagnetic) cells at GSM 900-MHz frequency but at very low SAR of just 0.05 W/kg. No statistically significant deficits were resolved by 8-arm maze³⁴. Expanding the exploration on the effects of radiation on mice, our group has performed a series of experiments to test spatial memory and learning in mice *Mus musculus* Balb/c using primarily the MWM task. The exposure setup consisted of a commercially available mobile phone, as firstly introduced by our group in insects^{7, 8} and applied recently as well in mice^{9, 35}. In these experiments free moving mice were irradiated within their home plastic cages, as also reported by other studies in rats^{30, 36}. The animals were exposed to a 2-hr daily dose of pulsed GSM 900-MHz voice modulated at a SAR level of 0.41 to 0.98 W/kg, for four consecutive days during the MWM task protocol. Extended analysis of the data revealed that the animals exposed to the near field of a commercially available mobile phone could not transfer the learned information across the training days. Moreover, the data of the memory probe trial showed that the exposed animals had difficulties in memory consolidation and/or retrieval of the stored information of the position of the hidden platform, since they showed no preference for the target quadrant. Before each set of experiments the mean power density of the radiation emitted by the mobile phone handset in the RF range at 900-MHz was measured with the field meter's probe placed inside the cage with the animals. The measured exposure values were in general within the established exposure limits by ICNIRP on 1998³⁷. We used commercially available digital mobile phone handsets, in order to analyse effects of real mobile telephony exposure conditions. Thus, instead of using simulations of digital mobile telephony signals with constant parameters (frequency, intensity, etc.), or even "test mobile phones" programmed to emit mobile telephony signals with controllable power or frequency, we used real GSM signals which are never constant since there are continuous changes in their intensity³⁵.

The SAR was approximately calculated according to the formula^{37, 38}:

$$\text{SAR} = \sigma E^2 / \rho$$

where E is the root mean square value of the electrical field, σ is the mean electrical conductivity of the tissues and ρ is the mass density. The SAR is a parameter widely used by many authors to compare the absorbed energy in different biological tissues. Thus, the parameters used for mice and rats were calculated according to Peyman *et al.*³⁹.

Another very promising and significant set of approaches involves experimental studies on volunteers and have focused on human cognitive function following exposure to mobile phone radiation (Table 1). One category of reports has shown memory improvement, i.e. facilitation in attention following exposure to mobile phone¹⁴. In another case, 915-MHz mobile phone exposure improved performance in a working memory task¹³, and in the same direction another study found improvement in cognitive tasks, i.e. verbal memory capacity, sustained attention and visuospatial working memory⁴⁰.

Also, DeSeze' group has studied on 2005 the outcomes from the daily use of mobile phones GSM 900 on cognitive function⁴¹. Fifty-five subjects (27 males and 28 females) were divided into two groups: a group with mobile phone switched on and a group with mobile phone switched off. The two groups were matched according to age, gender, and IQ. This double blind study lasted for 45 days and the neuropsychological test battery composed of 22 tasks, screened four neuropsychological categories: information processing, attention capacity, memory function, and executive function. This neuropsychological battery was performed four times, on day 2, day 15, day 29, and day 43. The results indicated that daily mobile phone use had no effect on cognitive function after a 13-hr rest period.

In a very interesting study Krause and collaborators assessed the effects of EMF emitted by mobile phones on the 1-20 Hz range by event-related brain oscillatory electroencephalogram (EEG) responses in children performing an auditory memory task (encoding and recognition)⁴². What they found was that EMF emitted by mobile phones has effects on brain oscillatory responses during cognitive processing at least in teenagers. Also in an attempt to test MW effects on human attention Russo and collaborators studied on 2006 a large sample of volunteers (168) using a series of cognitive tasks apparently sensitive to RF exposure (a simple reaction task, a vigilance task, and a subtraction task)⁴³. Participants performed those tasks twice, in two different sessions. In one session they were exposed to RF, with half of subjects exposed to GSM signals and the other half exposed to continuous waves (CW) signals, while in the other session they were exposed to sham signals. No significant effects of RF exposure on performance for either GSM or CW were found. On the other hand, it has been shown that in humans, exposure at 1 W/kg, to pulse-modulated radio frequency electromagnetic field 900 MHz, reduced reaction speed and increased accuracy in a working-memory task⁴⁴. The same study showed that exposure prior to sleep alters brain activity. For a summary of the available literature see Table 1.

The possible effects of CW and pulse modulated (PM) EMF on human cognition in 36 healthy male subjects were studied by Haarala and collaborators on 2007. They performed cognitive tasks while the volunteers were exposed to CW, PM, and sham EMF. They found no differences between the different EMF conditions⁴⁵.

In a just recent report, Bengt Arnetz' group investigated the effects of a 2 hr and 30 min RF exposure (884-MHz) on spatial memory and learning, using a double-blind repeated measures design⁶. The exposure was designed to mimic a real-life mobile phone conversation, at a SAR value of 1.4 W/kg. The primary outcome measure was a "virtual" spatial navigation task modelled after the commonly used and validated MWM. The distance travelled on each trial and the amount of improvement across trials

(i.e., learning) were used as dependent variables. The participants were daily mobile phone users, with and without symptoms attributed to regular mobile phone use. The symptomatic group improved their performance during RF exposure while there was no such effect in the non-symptomatic group (Table 1).

Conclusions

In the presented studies the effects of MW radiation deriving either from RF generator providing continuous or modulated mobile phone-like signal, or from conventional mobile phone either computer controlled or under normal communication, were investigated at various carrier frequencies, 900, 1800 and 2450 MHz on the spatial learning and memory of rodents and humans. Several investigators have demonstrated the commonality between the performance of humans on real time spatial navigation tasks as compared to rats, mice and most other mammals studied so far⁴⁶. The role of hippocampus, in particular, in navigation is concordant with neuronal response in rats and we assume in mice as well.

In our experiments using the MWM, Balb/c mice were required to find a submerged platform in the circular pool after 4 days of training by creating a “reference map” (reference memory)⁴⁷. Exposed mice to the near field of a conventional mobile phone showed difficulty in finding the position of the hidden platform during training and could not transfer the learned information across the days. The recorded data from the probe trial indicated that exposed mice had difficulty in memory consolidation and/or retrieval of the stored information³⁵.

A number of studies have used a range of SAR values, from 0.02 mW/kg up to 4 W/kg in order to induce and detect memory deficits in rodents and especially in rats. In the vast majority of the studies the Transversal Electromagnetic Mode (TEM) cells were used, exposing the animals at a given power density from an RF generator. Similar learning and memory deficits revealed with the MWM following exposure to pulsed circularly polarized 2450-MHz MW at 2 mW/cm² power density, have been also reported in rats²⁵. Some studies failed to reveal any effects whereas others have demonstrated that according to the radiation set up used (frequency, power density and duration of exposure) the animals' memory function is somehow affected by EMF (Table 1). In a very recent study Narayanan and collaborators using similar to ours exposure setup protocol irradiated male Wistar rats, 10-12 weeks old, which are developmentally comparable to human teenagers³⁰. The rats were exposed to 50 missed calls/day for 4 weeks from a GSM (900/1800-MHz) mobile phone in vibratory mode (no ring tone). After the experimental period, the animals were tested for spatial memory performance using the MWM test. Both phone exposed and sham exposed animals showed a significant decrease in escape time with training. In the probe trial phone exposed animals had significantly (~3 times) higher mean latency to reach the target quadrant and spent significantly (~2 times) less time in the target quadrant than age- and sex-matched controls. It is crucial to note that this work has used similar to ours experimental protocol having the mobile phone within the cage, but with longer exposure. It seems therefore that mice and rats respond similarly to the radiation stress by exhibiting deficits in their spatial memory operation. Some investigators (including our group) have chosen to perform experiments in animals allowed to move freely in their home cages during exposure to radiation^{9, 30, 35, 36}. Doing so, any possible confounding effects of restraint stress are minimized, since it is well known

that stress affects learning and memory⁴⁸. Exposure conditions were carefully selected in order to simulate as close as possible ordinary mobile phone use (duration and signal strength). EMF with changing parameters are found to be more bioactive than fields with constant parameters^{44, 49, 50}. That is probably because it is more difficult for living organisms to get adapted to them. Experiments with constant GSM or DCS signals can be performed, but they do not simulate actual conditions. International guidelines limit the local SAR to a maximum of 2 W/kg³⁷, or 1.6 W/kg³⁸. Since the maximum SAR value as calculated in our experiments was at most 0.98 W/kg and since this SAR value does not affect the mice's body temperature³⁷, the exposure conditions used in our experiments can be considered nonthermal.

Furthermore, some investigators (including us) selected the age of the experimental animals (50-day-old) to correspond approximately to that of late adolescence in humans, a population in which mobile phone use is particularly prevalent. Similar to our exposure conditions have been used by other investigators⁵¹; they have irradiated rats with conventional mobile phone operating at a maximum power of 0.607 W. They found by mRNA analysis an effect on injury associated proteins leading to cellular damage to the rat brain.

Since it is well known that performance in the MWM is dependent on the hippocampus, it is plausible to assume that MW radiation exposure affected this brain area. Such a notion may be supported by the observation that apoptotic cells have been detected in the hippocampus of rats after a 2 hr for 50 days GSM radiation^{31, 32}. Furthermore, the function of the hippocampus could be affected by the GSM irradiation possibly due to disruption of the blood-brain barrier, which has been reported to occur as a result of GSM irradiation^{52, 53}. However, other investigators using 915-MHz at power levels resulting in whole-body specific absorption rates of 0.0018-20 W/kg failed to reveal such a relationship⁵⁴.

Considering that memory functions are similar in mice and humans with respect to the involvement of the hippocampus⁵⁵, we may assume that upon using the mobile phone in contact with the head, a person may experience cognitive deficits. Interestingly, it has been reported that exposure to GSM 890-MHz radiation results in deficits of human cognitive function⁵⁶. The same research group reported recently using a spatial working memory task that the average reaction time (RT) of the right-hand responses under left-side exposure condition was significantly longer than those of the right-side and sham-exposure groups⁵⁷. These results confirmed the existence of an effect of exposure on RT, as well as the fact that exposure duration (together with the responding hand and the side of exposure) may play an important role in producing detectable radiofrequency radiation (RFR) effects on performance. It is notable that right and left hemispheres did not show similar patterns of activation. Differences in these parameters might be the reason for the failure of certain studies to detect or replicate RFR effects. The question whether the memory impairment is reversible is open for exploration by further experiments which are in progress. Finally the actual molecular impact of the EMF is being studied at the proteomics level in our lab, in an attempt to explain the molecular events underlying the brain cells' malfunction after irradiation.

It has been suggested that behavioral alterations induced by EMF are thermally mediated⁵⁸. That is because in most studies these effects derive from SAR values beyond the reference standard of 2 W/kg. The effects reported at very low SAR values may be explained by free radical formation as suggested⁵⁹. It could also be due to protein conformation changes⁶⁰. It might be possible that these changes cause alterations in cognitive function-related proteins, such as androgen receptors and apolipoprotein A⁶¹.

Finally, as questioned in a recent study by Philips and collaborators⁵⁹: “Are studies unable to replicate the work of others more credible than the original studies? In other words, can negative studies cancel positive studies or may studies showing effects be less valid because no explanation is provided?” The answer is that given the different frequency and modulation and in general the exposure set up conditions used in different studies, the issue remains open as to which of the parameters used in the “exposure cocktail”, is crucial to alter brain cells’ function. Is it the RF itself or the modulation? Or may be the ELF component of the battery switching mode of the cell phone. This issue is more complex than it seems when trying to compare animal studies with human clinical or experimental findings, possibly due to the differences in exposure conditions. Till the final elucidation of the effects, this research task is open for investigation requiring probably more sophisticated approaches and experimentation procedures.

References

1. Panagopoulos DJ, Margaritis LH. Mobile telephone radiation effects on living organisms. In: Harper AC, Buress RV, eds. Mobile telephones, networks, applications and performance. Nova Science Publishers, 2008, 107-49.
2. Hardell L, Carlberg M. Mobile phones, cordless phones and the risk for brain tumours. *Int J Oncol* 2009; 35(1): 5-17.
3. Khurana VG, Teo C, Kundi M, *et al.* Cell phones and brain tumors: a review including the long-term epidemiologic data. *Surg Neurol* 2009; 72(3): 205-14; discussion 214-5.
4. Hillert L, Akerstedt T, Lowden A, *et al.* The effects of 884 MHz GSM wireless communication signals on headache and other symptoms: an experimental provocation study. *Bioelectromagnetics* 2008; 29(3): 185-96.
5. Divan HA, Kheifets L, Obel C, *et al.* Prenatal and postnatal exposure to cell phone use and behavioral problems in children. *Epidemiology* 2008; 19(4): 523-9.
6. Wiholm C, Lowden A, Kuster N, *et al.* Mobile phone exposure and spatial memory. *Bioelectromagnetics* 2009; 30(1): 59-65.
7. Panagopoulos DJ, Karabarbounis A, Margaritis LH. Effect of GSM 900-MHz mobile phone radiation on the reproductive capacity of *Drosophila melanogaster*. *Electromagn Biol Med* 2004; 23(1): 29-43.
8. Panagopoulos DJ, Chavdoula ED, Nezis IP, *et al.* Cell Death induced by GSM-900MHz and DCS-1800MHz mobile telephony radiation. *Mut Res* 2007; 626(1-2): 69-78.
9. Fragopoulou AF, Koussoulakos SL, Margaritis LH. Cranial and postcranial skeletal variations induced in mouse embryos by mobile phone radiation. *Pathophysiology* 2010; 17(3):169-77
10. Dougherty KD, Turchin PI, Walsh TJ. Septocingulate and septohippocampal cholinergic pathways: involvement in working/episodic memory. *Brain Res* 1998; 810(1-2): 59-71.
11. Morris R. Development of a water-maze procedure for studying spatial learning in the rat. *J Neurosci Methods* 1984; 11: 47-60.
12. Maier R, Greter SE, Maier N. Effects of pulsed electromagnetic fields on cognitive processes - a pilot study on pulsed field interference with cognitive regeneration. *Acta Neurol Scand* 2004; 110(1): 46-52.
13. Keetley V, Wood AW, Spong J, *et al.* Neuropsychological sequelae of digital mobile phone exposure in humans. *Neuropsychologia* 2006; 44(10):1843-8.
14. Preece AW, Iwi G, Davies-Smith A, *et al.* Effect of a 915-MHz simulated mobile phone signal on cognitive function in man. *Int J Radiat Biol* 1999; 75(4): 447-56.
15. Koivisto M, Krause CM, Revonsuo A, *et al.* The effects of electromagnetic field emitted by GSM phones on working memory. *Neuroreport* 2000; 11(8): 1641-3.
16. Xu S, Ning W, Xu Z, *et al.* Chronic exposure to GSM 1800-MHz microwaves reduces excitatory synaptic activity in cultured hippocampal neurons. *Neurosci Lett* 2006; 398: 253-57.
17. Moisescu MG, Leveque P, Verjus MA, *et al.* 900 MHz modulated electromagnetic fields accelerate the clathrin-mediated endocytosis pathway. *Bioelectromagnetics* 2009; 30(3): 222-30.

18. Lai H. Spatial learning deficit in the rat after exposure to a 60 Hz magnetic field. *Bioelectromagnetics* 1996; 17: 494-6.
19. Lai H, Carino MA, Ushijima I. Acute exposure to a 60 Hz magnetic field affects rats' water-maze performance. *Bioelectromagnetics* 1998; 19(2): 117-22.
20. Jadidi M, Firoozabadi SM, Rashidy-Pour A, *et al.* Acute exposure to a 50 Hz magnetic field impairs consolidation of spatial memory in rats. *Neurobiol Learn Mem* 2007; 88(4): 387-92.
21. Lai H. Interaction of microwaves and a temporally incoherent magnetic field on spatial learning in the rat. *Physiol Behav* 2004; 82: 785-9.
22. Sienkiewicz ZJ, Haylock RG, Bartrum R, *et al.* 50 Hz magnetic field effects on the performance of a spatial learning task by mice. *Bioelectromagnetics* 1998; 19(8): 486-93.
23. Lai H, Horita A, Guy AW. Microwave irradiation affects radial-arm maze performance in the rat. *Bioelectromagnetics* 1994; 15: 95-104.
24. Wang B, Lai H. Acute exposure to pulsed 2450-MHz microwaves affects water-maze performance of rats. *Bioelectromagnetics* 2000; 21: 52-6.
25. Cobb BL, Jauchem JR, Adair ER. Radial arm maze performance of rats following repeated low level microwave radiation exposure. *Bioelectromagnetics* 2004; 25(1): 49-57.
26. Cassel JC, Cosquer B, Galani R, *et al.* Whole-body exposure to 2.45 GHz electromagnetic fields does not alter radial-maze performance in rats. *Behav Brain Res* 2004; 155: 37-43.
27. D'Andrea JA. Behavioral evaluation of microwave irradiation. *Bioelectromagnetics* 1999; Suppl 4: 64-74. Review.
28. Dubreuil D, Jay T, Edeline JM. Head-only exposure to GSM 900-MHz electromagnetic fields does not alter rat's memory in spatial and non-spatial tasks. *Behav Brain Res* 2003; 145(1-2): 51-61.
29. Cosquer B, Kuster N, Cassel JC. Whole-body exposure to 2.45 GHz electromagnetic fields does not alter 12-arm radial-maze with reduced access to spatial cues in rats. *Behav Brain Res* 2005; 161: 331-4.
30. Narayanan SN, Kumar RS, Potu BK, *et al.* Spatial memory performance of Wistar rats exposed to mobile phone. *Clinics* 2009; 64(3): 231-4.
31. Salford LG, Nittby H, Brun A, *et al.* Non-thermal effects of EMF upon the mammalian brain – the lund experience. *The Environmentalist* 2007; 27: 493-500.
32. Salford LG, Brun AE, Eberhardt JL, *et al.* Nerve cell damage in mammalian brain after exposure to microwaves from GSM mobile phones. *Environ Health Perspec* 2003; 111(7): 881-3.
33. Nittby H, Grafström G, Tian DP, *et al.* Cognitive impairment in rats after long-term exposure to GSM-900 mobile phone radiation. *Bioelectromagnetics* 2008; 29(3): 219-32.
34. Sienkiewicz ZJ, Blackwell RP, Haylock RG, *et al.* Low-level exposure to pulsed 900 MHz microwave radiation does not cause deficits in the performance of a spatial learning task in mice. *Bioelectromagnetics* 2000; 21(3): 151-8.
35. Fragopoulou AF, Miltiadou P, Stamatakis A, *et al.* Whole body exposure with GSM 900 MHz affects spatial memory in mice. *Pathophysiology* 2010; 17(3):179-87.
36. Ferreira AR, Knakievicz T, Pasquali MA, *et al.* Ultra high frequency-electromagnetic field irradiation during pregnancy leads to an increase in erythrocytes micronuclei incidence in rat offspring. *Life Sci* 2006; 80: 43-50.
37. ICNIRP. Guidelines for limiting exposure to time-varying electric, magnetic and electromagnetic fields (up to 300GHz). *Health Phys* 1998; 74: 494-522.
38. IEEE/ANSI. IEEE C95.1-1991: IEEE standard for safety levels with respect to human exposure to radio frequency electromagnetic fields, 3 kHz to 300 GHz. New York: The IEEE Inc, 1992; 1-76.
39. Peyman A, Rezaazadeh AA, Gabriel C. Changes in the dielectric properties of rat tissue as a function of age at microwave frequencies. *Phys Med Biol* 2001; 46: 1617-29.
40. Edelstyn N, Oldershaw A. The acute effects of exposure to the electromagnetic field emitted by mobile phones on human attention. *Neuroreport* 2002; 13(1): 119-21.
41. Besset A, Espa F, Dauvilliers Y, *et al.* No effect on cognitive function from daily mobile phone use. *Bioelectromagnetics* 2005; 26(2): 102-8.
42. Krause CM, Björnberg CH, Pesonen M, *et al.* Mobile phone effects on children's event-related oscillatory EEG during an auditory memory task. *Int J Radiat Biol* 2006; 82(6): 443-50.
43. Russo R, Fox E, Cinel C, *et al.* Does acute exposure to mobile phones affect human attention? *Bioelectromagnetics* 2006; 27(3): 215-20.

44. Regel SJ, Tinguely G, Schuderer J, *et al.* Pulsed radio frequency radiation affects cognitive performance and the waking electroencephalogram. *Neuroreport* 2007; 18(8): 803-7.
45. Haarala C, Takio F, Rintee T, *et al.* Pulsed and continuous wave mobile phone exposure over left versus right hemisphere: effects on human cognitive function. *Bioelectromagnetics* 2007; 28(4): 289-95.
46. Maguire EA, Frith CD, Burgess N, *et al.* Knowing where things are parahippocampal involvement in encoding object locations in virtual large-scale space. *Cogn Neurosci* 1998; 10(1): 61-76.
47. Noonan M, Penque M, Axelrod S. Septal lesions impair rats' Morris test performance but facilitate left-right response differentiation. *Physiol Behav* 1996; 60(3): 895-900.
48. Joëls M, Pu Z, Wiegert O, *et al.* Learning under stress: how does it work? *Trends Cogn Sci* 2006; 10(4): 152-8.
49. Goodman EM, Greenebaum B, Marron MT. Effects of electro- magnetic fields on molecules and cells. *International Rev Cytol* 1995; 158: 279-338.
50. Diem E, Schwarz C, Adlkofer F, *et al.* Non-thermal DNA breakage by mobile-phone radiation (1800 MHz) in human fibroblasts and in transformed GFSH-R17 rat granulosa cells in vitro. *Mutat Res* 2005; 583(2): 178-83.
51. Yan JG, Agresti M, Zhang LL, *et al.* Upregulation of specific mRNA levels in rat brain after cell phone exposure. *Electromagn Biol Med* 2008; 27(2): 147-54.
52. Salford LG, Brun A, Stuesson K, *et al.* Permeability of the blood-brain barrier induced by 915 MHz electromagnetic radiation, continuous wave and modulated at 8, 16, 50, and 200 Hz. *Microsc Res Tech* 1994; 27(6): 535-42.
53. Nitby H, Grafström G, Eberhardt JL, *et al.* Radiofrequency and extremely low-frequency electromagnetic field effects on the blood-brain barrier. *Electromagn Biol Med* 2008; 27(2): 103-26.
54. McQuade JM, Merritt JH, Miller SA, *et al.* Radiofrequency-radiation exposure does not induce detectable leakage of albumin across the blood-brain barrier. *Radiation Res* 2009; 171(5): 615-21.
55. Hammond RS, Tull LE, Stackman RW. On the delay-dependent involvement of the hippocampus in object recognition memory. *Neurobiol Learn Mem* 2004; 82(1): 26-34.
56. Eliyahu I, Luria R, Hareuveny R, *et al.* Effects of radiofrequency radiation emitted by cellular telephones on the cognitive functions of humans. *Bioelectromagnetics* 2006; 27(2): 119-26.
57. Luria R, Eliyahu I, Hareuveny R, *et al.* Cognitive effects of radiation emitted by cellular phones: the influence of exposure side and time. *Bioelectromagnetics* 2009; 30(3): 198-204.
58. D'Andrea JA, Adair ER, de Lorge JO. Behavioral and cognitive effects of microwave exposure. *Bioelectromagnetics* 2003; Suppl 6: S39-62. Review.
59. Phillips JL, Singh NP, Lai H. Electromagnetic fields and DNA damage. *Pathophysiology* 2009; 16(2-3): 79-88.
60. Caraglia M, Marra M, Mancinelli F, *et al.* Electromagnetic fields at mobile phone frequency induce apoptosis and inactivation of the multi-chaperone complex in human epidermoid cancer cells. *J Cell Physiol* 2005; 204: 539-48.
61. Raber J. AR, apoE, and cognitive function. *Horm Behav* 2008; 53: 706-15.

Provocation study using heart rate variability shows microwave radiation from 2.4 GHz cordless phone affects autonomic nervous system

Magda Havas*, Jeffrey Marrongelle**, Bernard Pollner***,
Elizabeth Kelley****, Camilla R.G. Rees*****, Lisa Tully*****

* Environmental and Resource Studies, Trent University, Peterborough, Canada

** 1629 Long Run Road, PO Box 606, Schuylkill Haven, PA, USA

*** Haspingerstrasse 7/2, 6020 Innsbruck, Austria

**** International Commission for Electromagnetic Safety, Venice, Italy

***** 350 Bay Street, #100-214, San Francisco, California, 94133, USA

***** 27 Arrow Leaf Court, Boulder, Colorado 80304, USA

Abstract

Aim: The effect of pulsed (100 Hz) microwave (MW) radiation on heart rate variability (HRV) was tested in a double blind study. **Materials and Methods:** Twenty-five subjects in Colorado between the ages of 37 to 79 completed an electrohypersensitivity (EHS) questionnaire. After recording their orthostatic HRV, we did continuous real-time monitoring of HRV in a provocation study, where supine subjects were exposed for 3-minute intervals to radiation generated by a cordless phone at 2.4 GHz or to sham exposure. **Results:** Questionnaire: Based on self-assessments, participants classified themselves as extremely electrically sensitive (24%), moderately (16%), slightly (16%), not sensitive (8%) or with no opinion (36%) about their sensitivity. The top 10 symptoms experienced by those claiming to be sensitive include memory problems, difficulty concentrating, eye problems, sleep disorder, feeling unwell, headache, dizziness, tinnitus, chronic fatigue, and heart palpitations. The five most common objects allegedly causing sensitivity were fluorescent lights, antennas, cell phones, Wi-Fi, and cordless phones. **Provocation Experiment:** Forty percent of the subjects experienced some changes in their HRV attributable to digitally pulsed (100 Hz) MW radiation. For some the response was extreme (tachycardia), for others moderate to mild (changes in sympathetic nervous system and/or parasympathetic nervous system). and for some there was no observable reaction either because of high adaptive capacity or because of systemic neurovegetative exhaustion. **Conclusions:** Orthostatic HRV combined with provocation testing may provide a diagnostic test for some EHS sufferers when they are exposed to electromagnetic emitting devices. This is the first study that documents immediate and dramatic changes in both Heart Rate (HR) and HR variability (HRV) associated with MW exposure at levels

Address: Magda Havas BSc, PhD, Environmental and Resource Studies, Trent University, Peterborough, ON, K9J 7B8, Canada - Tel. 705 748-1011 x7882 - Fax 705-748-1569
E-mail: mhavas@trentu.ca

well below (0.5%) federal guidelines in Canada and the United States (1000 microW/cm²).

Key Words: heart rate variability, microwave radiation, DECT phone, autonomic nervous system, provocation study, sympathetic, parasympathetic, cordless phone, 2.4 GHz, electrohypersensitivity

Introduction

A growing population claims to be sensitive to devices emitting electromagnetic energy. Hallberg and Oberfeld¹ report a prevalence of electrohypersensitivity (EHS) that has increased from less than 2% prior to 1997 to approximately 10% by 2004 and is expected to affect 50% of the population by 2017. Whether this is due to a real increase in EHS or to greater media attention, is not known. However, to label EHS as a psychological disorder or to attribute the symptoms to aging and/or stress does not resolve the issue that a growing population, especially those under the age of 60, are suffering from some combination of fatigue, sleep disturbance, chronic pain, skin, eye, hearing, cardiovascular and balance problems, mood disorders as well as cognitive dysfunction and that these symptoms appear to worsen when people are exposed to electromagnetic emitting devices²⁻⁷.

The World Health Organization (WHO) organized an international seminar and working group meeting in Prague on EMF Hypersensitivity in 2004, and at that meeting they defined EHS as follows⁸:

“ . . . a phenomenon where individuals experience adverse health effects while using or being in the vicinity of devices emanating electric, magnetic, or electromagnetic fields (EMFs) . . . Whatever its cause, EHS is a real and sometimes a debilitating problem for the affected persons . . . Their exposures are generally several orders of magnitude under the limits in internationally accepted standards.”

The WHO goes on to state that:

“EHS is characterized by a variety of non-specific symptoms, which afflicted individuals attribute to exposure to EMF. The symptoms most commonly experienced include dermatological symptoms (redness, tingling, and burning sensations) as well as neurasthenic and vegetative symptoms (fatigue, tiredness, concentration difficulties, dizziness, nausea, heart palpitation and digestive disturbances). The collection of symptoms is not part of any recognized syndrome.”

Both provocation studies (where individuals are exposed to some form of electromagnetic energy and their symptoms are documented) and amelioration studies (where exposure is reduced) can shed light on the offending energy source and the type and rate of reaction.

Several amelioration studies have documented improvements in the behavior of students and the health and wellbeing of teachers⁹, among asthmatics¹⁰, and in both diabetics and those with multiple sclerosis^{11,12} when their exposure to dirty electricity is reduced. Dirty electricity refers to microsurgs flowing along electrical wires in the kHz

range that can damage sensitive electronic equipment and, it appears, affect the health of those exposed.

In contrast to amelioration studies, provocation studies, examining the response of people with self-diagnosed EHS, have generated mixed results.

Rea *et al.*¹³ were one of the first to show that sensitive individuals responded repeatedly to several frequencies between 0.1 Hz and 5 MHz but not to blank challenges. Reactions were mostly neurological and included tingling, sleepiness, headache, dizziness, and - in severe cases - unconsciousness, although other symptoms were also observed including pain of various sorts, muscle tightness particularly in the chest, spasm, palpitation, flushing, tachycardia, etc. In addition to the clinical symptoms, instrument recordings of pupil dilation, respiration, and heart activity were also included in the study using a double-blind approach. Results showed a 20% decrease in pulmonary function and a 40% increase in heart rate. These objective instrumental recordings, in combination with the clinical symptoms, demonstrate that EMF sensitive individuals respond physiologically to certain EMF frequencies although responses were robust for only 16 of the 100 potentially sensitive individuals tested.

In a more recent review, Rubin *et al.*¹⁴ concluded that there was no robust evidence to support the existence of a biophysical hypersensitivity to EMF. This was based on 31 double-blind experiments that tested 725 EHS subjects. Twenty-four studies found no difference between exposure and sham conditions and of the seven studies that did find some evidence that exposure affected EHS participants, the research group failed to replicate the results (two studies) or the results appeared to be statistical artifacts (three studies).

Those who live near antennas and those who suffer from EHS often complain of cardiovascular problems such as rapid heart rate, arrhythmia, chest pain, and/or changes in blood pressure^{3,7,15,16}.

Indeed, the doctors who signed the Freiburger Appeal¹⁷ stated the following:

“We have observed, in recent years, a dramatic rise in severe and chronic disease among our patients especially . . . extreme fluctuations in blood pressure, ever harder to influence with medications; heart rhythm disorders; heart attacks and strokes among an increasingly younger population . . .”

Based on these findings we decided to study the affect of microwave (MW) radiation generated by a digital cordless phone on the cardiovascular system by monitoring heart rate variability (HRV). Unlike cell phones that radiate microwaves only when they are either transmitting or receiving information, the cordless phone we used radiates constantly as long as the base of the phone is plugged into an electrical outlet. The phone we used was an AT&T digitalally pulsed (100 Hz) cordless telephone that operates at 2.4 GHz or frequencies commonly used for microwave ovens and Wi-Fi. It resembles its European version know as a Digital Enhanced Cordless Telecommunications (DECT) phone that operates at 1.9 GHz¹⁸.

HRV is increasingly used for screening cardiovascular and neurological disorders¹⁹⁻²⁴. We wanted to determine whether HRV could be used as a tool to diagnose EHS and whether it could be used to predict probability and/or intensity of the reaction to a MW provocation. The HRV analysis, using NervExpress software^{25,26}, provides information about the functioning of the sympathetic and parasympathetic nervous system with real time monitoring and provides additional information including a pre-exposure fitness score based on the orthostatic test.

Materials and methods

Background electromagnetic environment

Testing was done in two locations, one in Golden and the other in Boulder, Colorado, on three separate weekdays during a 6-day period (Table 1). Background levels of low frequency magnetic fields, intermediate frequency radiation on electrical wires, and radio frequency radiation were monitored at each location and the values are provided in Table 1. All testing of the electromagnetic environment was done in the area where volunteers were tested for their heart rate variability during the provocation study.

The extremely low frequency **magnetic field** was measured with an omni-directional Trifield meter. This meter is calibrated at 60 Hz with a frequency-weighted response from 30 to 500 Hz and a flat response from 500 to 1000 Hz. Accuracy is $\pm 20\%$.

Power quality was measured with a Microsurge Meter that measures high frequency transients and harmonics between 4 and 150 kHz (intermediate frequency range). This meter provides a digital reading from 1 to 1999 of dv/dt expressed as GS units with a $\pm 5\%$ accuracy²⁷. Since we were trying to ensure low background exposure, we installed GS filters to improve power quality. The results recorded are with GS filters installed.

Within at least 100 m of the testing area, all wireless devices (cell phones, cordless phones, wireless routers) were turned off. **Radio frequency radiation** from outside the testing area was measured with an Electrosmog Meter, which has an accuracy of ± 2.4 dB within the frequency range of 50 MHz to 3.5 GHz. Measurements were conducted using the omni-directional mode and were repeated during the testing. This meter was also used to determine the exposure of test subjects during provocation with a digital cordless phone. This **cordless phone** emits radio frequency radiation when the base station is plugged into an electrical outlet. This happens even when the phone is not in use. We used the base station of an AT&T 2.4 GHz phone (digitally pulsed at 100 Hz) to expose subjects to MW radiation¹⁸. The emission of MWs at different distances from the front of the base station is provided in fig. 1.

Testing of subjects

Subjects were **recruited** by word-of-mouth based on their availability during a short period of testing. Of the 27 people who volunteered to be tested, two were excluded, one based on age (less than 16 years old) and another based on a serious heart condition.

Subjects were asked to complete a wellness and EHS **questionnaire**. They were then asked questions about their age, height, weight, blood type, time of last meal, and occupation (in the event of occupational exposure to electromagnetic fields/radiation).

Table 1 - Measurements of the electromagnetic environment at each testing location

Location	Date	Magnetic Field 30 - 1000 Hz mG	Power Quality 4 - 150 kHz GS units	Radio Frequency Radiation 50 MHz - 3.5 GHz microW/cm ²
Colorado				
Golden	10/16/08	3 - 15	140	0.8
Boulder	10/20/08	0.4	37	<0.01
Boulder	10/21/08	0.4	80	<0.01

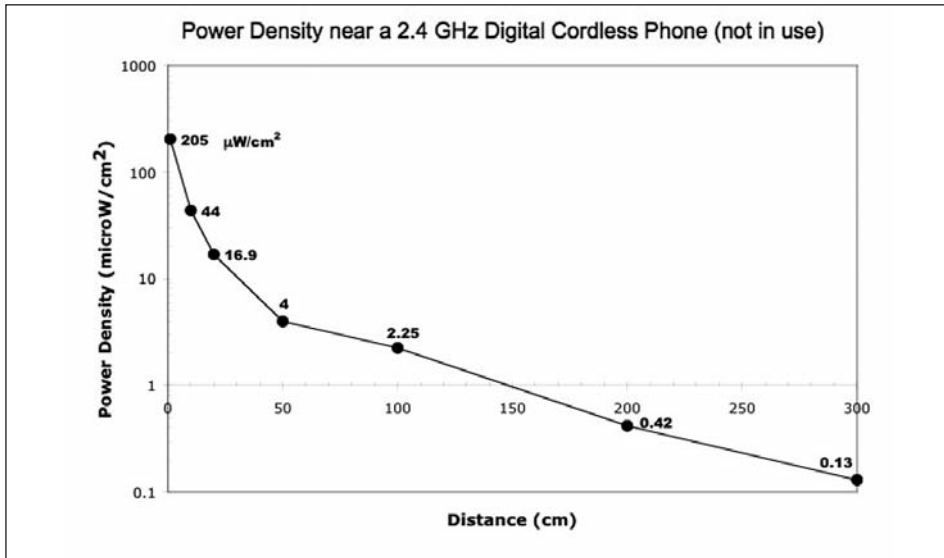

Fig. 1. Radiation near a 2.4 GHz AT&T digital cordless phone when the base station of the phone is plugged into an electrical outlet and the phone is not in use

We measured resting heart rate and blood pressure using a Life Source UA-767 Plus digital blood pressure monitor; saliva pH with pH ion test strips designed for urine and saliva (pH range 4.5-9.0), and blood sugar with ACCU-CHEK Compact Plus.

In an attempt to address the question: “Is there a simple test that relates EHS with the electrical environment of the human body?”, we measured galvanic skin response (GSR), body voltage, and the high and low frequency electric and magnetic field of each subject.

Wrist-to-wrist galvanic skin response was measured as an indicator of stress using a Nexxtech voltmeter (Cat. No. 2200810) set at 20 volts DC and attached to the inner wrist with a Medi Trace 535 ECG Conductive Adhesive Electrodes Foam used for ECG monitoring. Capacitively coupled “body voltage” was measured with a MSI Multimeter connected to a BV-1 body voltage adaptor. The subject’s thumb was placed on one connector and the other connector was plugged into the electrical ground, which served as the reference electrode. High frequency (HF) and low frequency (LF) electric and magnetic fields were measured with a Multidetektor II Profi Meter held at approximately 30 cm from the subject’s body, while the subject was seated.

HRV testing

Two types of HRV testing were conducted. The first was an *orthostatic* test and the second was *continuous monitoring* of heart rate variability with and without provocation (exposure to MW frequencies from a digital cordless phone). NervExpress software was used for HRV testing²⁵. NervExpress has both CE and EU approval and is a Class Two Medical Device in Canada and in the European Union. An electrode belt with transmitter was placed on the person’s chest near the heart, against the skin. A wired HRV cable with receiver was clipped to the clothing near the transmitter and connected to the COM

port of the computer for acoustical-wired transmission (not wireless). This provided continuous monitoring of the interval between heartbeats (R-R interval).

For the *orthostatic* testing subject laid down on his/her back and remained in this position for 192 R-R intervals or heartbeats (approximately 3 minutes), at which time a beep from the computer indicated that the person stand up and remain standing until the end of the testing period, which was 448 intervals (approximately 7 minutes depending on heart rate).

For the *provocation* testing, subject remained in a lying down position for the duration of the testing. A digital cordless phone base station, placed approximately 30 to 50 cm from subject's head, was then connected randomly to either a live (real exposure) or dead (sham exposure) extension cord. It was not possible for the subject to know if the cordless phone was on or off at any one time. Continuous real-time monitoring recorded the interval between each heartbeat. Data were analyzed by timed stages consisting of 192 R-R intervals (heartbeats).

The sham exposures are referred to as either pre-MW exposure or post-MW exposure to differentiate the order of testing. Since type of exposure was done randomly in some instances either the pre-MW or the post-MW is missing. Subjects who reacted immediately to the cordless phone were retested with more real/sham exposures. When subject was exposed multiple times, only the first exposure was used for comparison. Provocation testing took between 9 to 30 minutes per subject.

After the initial testing, treatments (deep breathing, laser acupuncture, Clean Sweep) that might alleviate symptoms were tried on a few subjects but these results will be reported elsewhere.

Interpretation of HRV results

The results for the orthostatic testing and provocation testing were sent to one of the authors (JM) for interpretation. An example of the type of information send is provided in fig. 2 (orthostatic) and fig. 3 (provocation). No information was provided about the subject's self-proclaimed EHS and the information about exposure was blinded. JM did not examine the provocation results until he reviewed the orthostatic results. No attempt was made to relate the two during this initial stage of interpretation.

Predicting response and health based on orthostatic test

For the orthostatic testing JM provided a ranking for cardiovascular tone (CVT), which is based on the blood pressure and heart rate (sum of systolic and diastolic blood pressure times heart rate) and provides information on whether the cardiovascular system is hypotonic (<12,500) or hypertonic (>16,500). We used a 5-point ranking scale as follows: Rank 1: < 12,500, hypotonic; Rank 2: 12,500 to 14,000; Rank 3: 14,000 to 15,500; Rank 4: 15,500 to 16,500; Rank 5: > 16,500, hypertonic.

Non-Adaptive Capacity (NAC)^a was ranked on a 5-point scale with 1 indicating highly adaptive and 5 indicating highly non-adaptive. This was based on a balanced sympathetic (SNS) and parasympathetic (PSNS) nervous system (average orthostatic response within ± 1 standard deviation from center on graph) and on the overall fitness

^a Later Adaptive Capacity (AC) was used, which is the inverse of NAC.

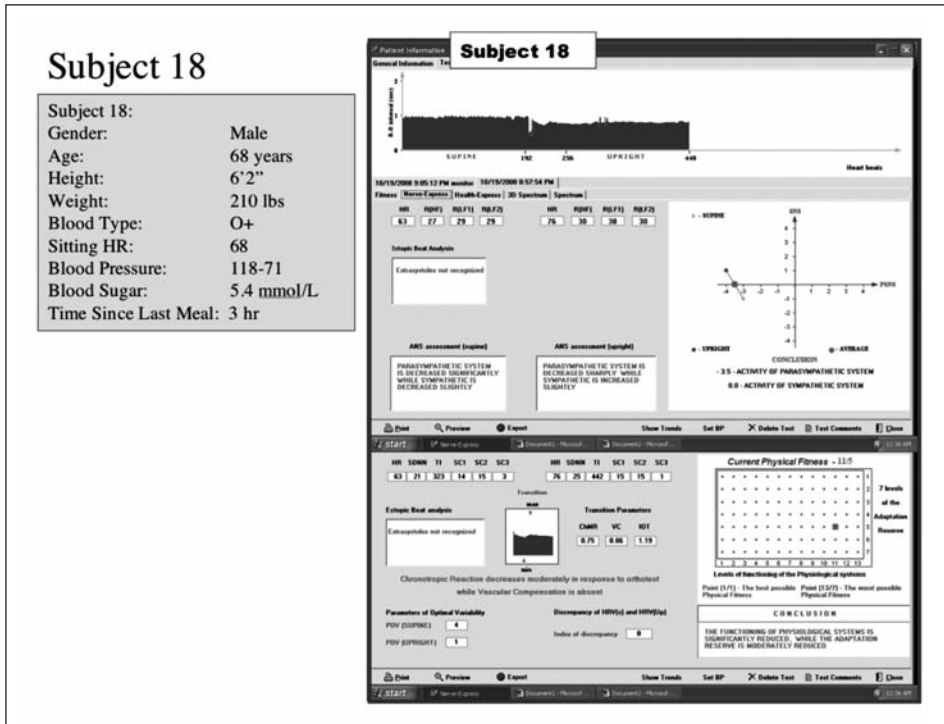

Fig. 2. Orthostatic HRV information provided for blinded analysis of Subject 18

score. The closer to normal value of the autonomic nervous system (ANS) in a given subject, the less likely they are to react, since their adaptive capacity is high. “Normal” refers to the balanced SNS/PSNS and the appropriate direction of movement under stress, in this case when person stood up. Direction of movement is shown in the NervExpress graph (fig. 2). Appropriate direction of movement would be either up 1 standard deviation (small increase in SNS and no change in PSNS); up and to the left 1 standard deviation each (small increase in SNS and small decrease in PSNS); or to left (no change in SNS and slight decrease in PSNS). For those who move further to the left (greater down regulation of PSNS) or further up and to the left (greater up regulation of SNS combined with a greater down regulation of PSNS), the less likely they are to adapt and the more likely they are to react. Likewise, if the fitness score is high or adequate, the individual would be capable of resisting the stressor. An adequate physical fitness score is between 1:1 and 10:6. The first number refers to the functioning of the physiological system and the second is the adaptation reserve. The lower the numbers the greater the level of fitness in each category. Note, if a subject with good or adequate fitness was to be a reactor to MW stress, his/her reaction would be both rapid and strong.

Probability of Reaction (POR) was ranked on a 5-point scale with “1” indicating low probability of a reaction and “5” indicating high probability of a reaction to stress of any kind. Criteria were similar to the NAC. However, greater consideration was given to the Chronotropic Myocardial Reaction Index (ChMR) value and the dysautonomic

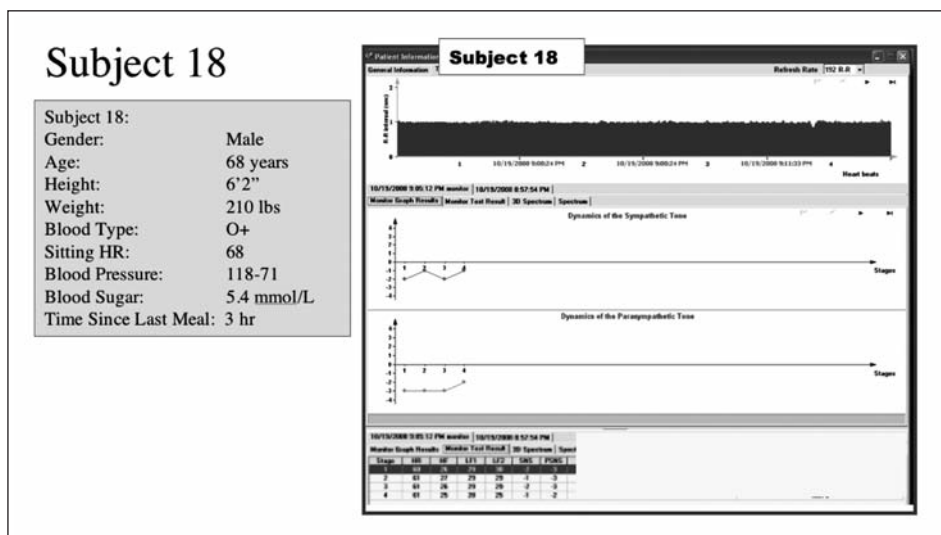

Fig. 3. Continuous monitoring of HRV with real and sham exposure to MW radiation from a digital cordless phone. Information provided for blinded analysis of Subject 18

status (average of orthostatic test is more than two standard deviations from center or up to the right) of the subject, whereby individuals with compromised ANS and a poor ChMR ranking (outside the range of 0.53 to 0.69) would be most likely to react and *vice versa*.

A potential non-responding reactor is someone with low energy, average orthostatic response in lower left quadrante, and a physical fitness score between 10:6 and 13:7. Subject 18 in fig. 2 is a borderline non-responding reactor. Note, this does not necessarily imply that this person is hypersensitive, only that he probably does not have enough energy to mount a reaction even if he was EHS.

JM also provided his comments on the health status of the subject based on the rhythmogram, autonomic nervous system assessment (changes in the SNS and PSNS), Fitness Score, Vascular Compensation Reaction (VC), ChMR, Compensation Response (CR), Ortho Test Ratio (OTR), Parameters of Optimal Variability (POV), Index of Discrepancy (ID); and Tension Index (TI). The interpretation of the HRV parameters is dependant to a certain degree on the integration of all the data provided as a whole with value being given to the total ANS picture presented. Those skilled in the art and science of HRV analysis should reach similar interpretive assessment of the data presented here²⁶.

Blinded analysis of provocation results

The blinded data for the continuous monitoring of heart rate variability with real and sham exposure were sent to JM for analysis (fig. 3). JM attempted to identify the stage during which exposure took place, stage during which the subject reacted, and then ranked symptom probability (5-point scale) and intensity (non-reactive, mild, moderate, intense). The assessment is provided in Appendix A.

Wellness and EHS Questionnaire

Prior to any testing, each subject was asked to complete a wellness and EHS questionnaire. This was designed on surveymonkey (www.surveymonkey.com) and was administered in paper format. This questionnaire was analyzed separately from the HRV data.

Results

Background electromagnetic environment

The two environments, where we conducted the testing, differed in their background levels of EMF and electromagnetic radiation (EMR). The Golden site had high magnetic fields (3-15 mG), high levels of dirty electricity (140 GS units) despite the GS filters being installed, and elevated levels of radio frequency (RF) radiation (0.8 microW/cm²) coming from 27 TV transmitters on Lookout Mountain within 4 km of our testing environment. Despite RF reflecting film on windows the RF levels inside the home were elevated. The Boulder environment was relatively pristine and differed only with respect to power quality on the two days of testing (Table 1).

The cordless phone, used for provocation, produced radiation that was maximal at the subject's head (3 to 5 microW/cm²) and minimal at the subject's feet (0.2 to 0.8 microW/cm²) depending on height of subject and the environment. The cordless phone did not alter magnetic field or power quality.

Participants

A total of 25 subjects were included in this pilot study, ranging in age from 37 to 79 with most (40%) of the subjects in their 50s (Table 2). Eighty percent were females. Approximately half of the participants had normal body mass index and the other half were either overweight (28%) or obese (16%)²⁸. Mean resting heart rate for this group was 70 (beats per minute) and ranged from 53 to 81. Blood pressure fell within a normal range for 40% of participants and fell within stage 1 of high blood pressure for 16% of the subjects²⁹. None of the subjects had pacemakers, a prerequisite for the study. Forty percent had mercury amalgam fillings and 28% had metal (artificial joints, braces, etc.) in their body. This is relevant as metal implants and mercury fillings may relate to EHS³⁰.

Questionnaire

Self-perceived Electrosensitivity

One third of participants did not know if they were or were not electrically sensitive, 40% believed they were moderately to extremely sensitive, 16% stated that they had a little sensitivity, and 8% claimed they were not at all sensitive. Their sensitivity was slightly debilitating for 24% and moderately debilitating for 20% of participants (fig. 4).

Reaction time for symptoms to appear after exposure ranged from immediately (12%) to within 2 hours (4%) and was within 10 minutes for the majority of those who believe they react (28%) (fig. 5). Recovery time ranged from immediately to within 1 day with

Table 2 - Information about participants

		#	%
Gender	Male	5	20%
	Female	20	80%
Age	Mean and Range	60 years	37-79 years
Age Class	20s	1	4%
	30s	1	4%
	40s	2	8%
	50s	10	40%
	60s	5	20%
	70s	7	28%
BMI ^a	obese	4	16%
	overweight	7	28%
	normal	13	52%
	underweight	1	4%
Resting Heart Rate	Mean and Range	70 bpm	53-81 bpm
Blood Pressure ^b	Normal	10	40%
	Pre-hypertension	11	44%
	High Blood Pressure	4	16%
Metal in Body	Pace maker	0	0%
	Mercury fillings	10	40%
	Other metal	7	28%

^a BMI = Body Mass Index based on height and weight²⁸

^b Blood Pressure (BP) according to National Heart Lung and Blood Institute (nd)²⁹

only 4% claiming to recover immediately. Several participants noted that the rate of reaction and recovery is a function of the severity of their exposure and their state of health. The more intense the exposure the more rapid their response and the slower their rate of recovery. These results may have a bearing on the provocation study as we are testing an immediate reaction/recovery response (~3 minutes) to a moderate intensity exposure (3 to 5 $\mu\text{W}/\text{cm}^2$) and the percent that claims to respond quickly is low among this group.

Symptoms

The most common symptoms of exposure to electrosmog, as identified by this group of participants, included poor short-term memory, difficulty concentrating, eye problems, sleep disorder, feeling unwell, headache, dizziness, tinnitus, chronic fatigue and heart palpitations (fig. 6, upper graph). Of the symptoms commonly associated with EHS, heart palpitations (10th), rapid heartbeat (18th), arrhythmia (21st), and slower heartbeat (23rd) are the only ones we would be able to identify with HRV testing. For most participants who claim to react, reactions are mild to moderate.

All of the symptoms, except high blood pressure, arrhythmia, and slower heartbeat, were experienced several times per day (daily) or several times per week (weekly) by at least one or more participants. The patterns for symptom severity and frequency are similar (fig. 6, upper vs lower graph). Some of the symptoms (feeling unwell, pain, chronic fatigue, gas/bloat, skin problems) were experienced several times each month (monthly) may relate to menses in pre-menopausal or peri-menopausal women (16 women).

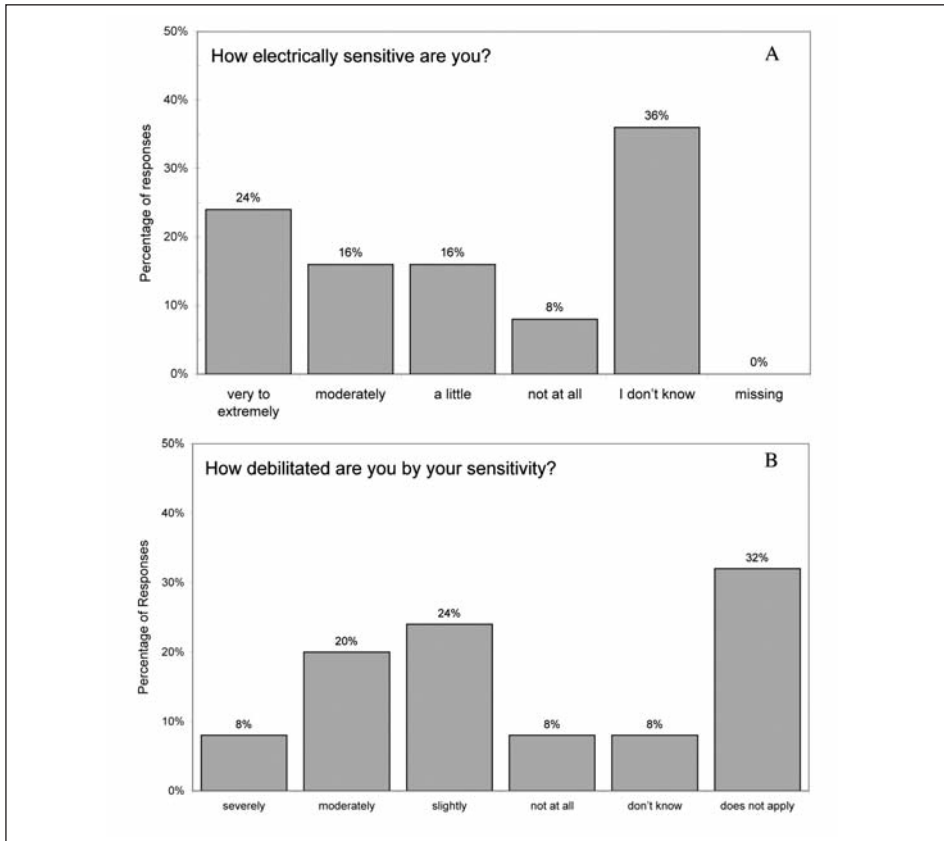

Fig. 4. Self-proclaimed electrosensitivity of participants (n=25)

A large percentage of participants had food allergies (64%), mold/pollen/dust allergies (48%), pet allergies (20%), and were chemically sensitive (36%) (fig. 7).

Some also had pre-existing health/medical conditions (fig. 8). The top five were anxiety (28%); hypo-thyroidism (24%); autoimmune disorder (20%), depression (16%) and high blood pressure (16%). Note these may be self-diagnosed rather than medically diagnosed conditions.

Objects contributing or associated with adverse health symptoms

Among the objects identified as contributing to adverse health symptoms, tube fluorescent lights were at the top of the list with more than 40% of participants reacting *often* or *always* (fig. 9). The next 4 items on the list (antennas, cell phones, Wi-Fi, cordless phones) all emit microwave radiation. According to this figure 16% of subjects respond to cordless phones *often* or *always* and their responses may include headaches, dizziness, depression, which we are unable to monitor with HRV.

Fifty-two percent stated they are debilitated by their sensitivity, 24% slightly, 20% moderately, and 8% severely. Some have difficult shopping, which may relate to

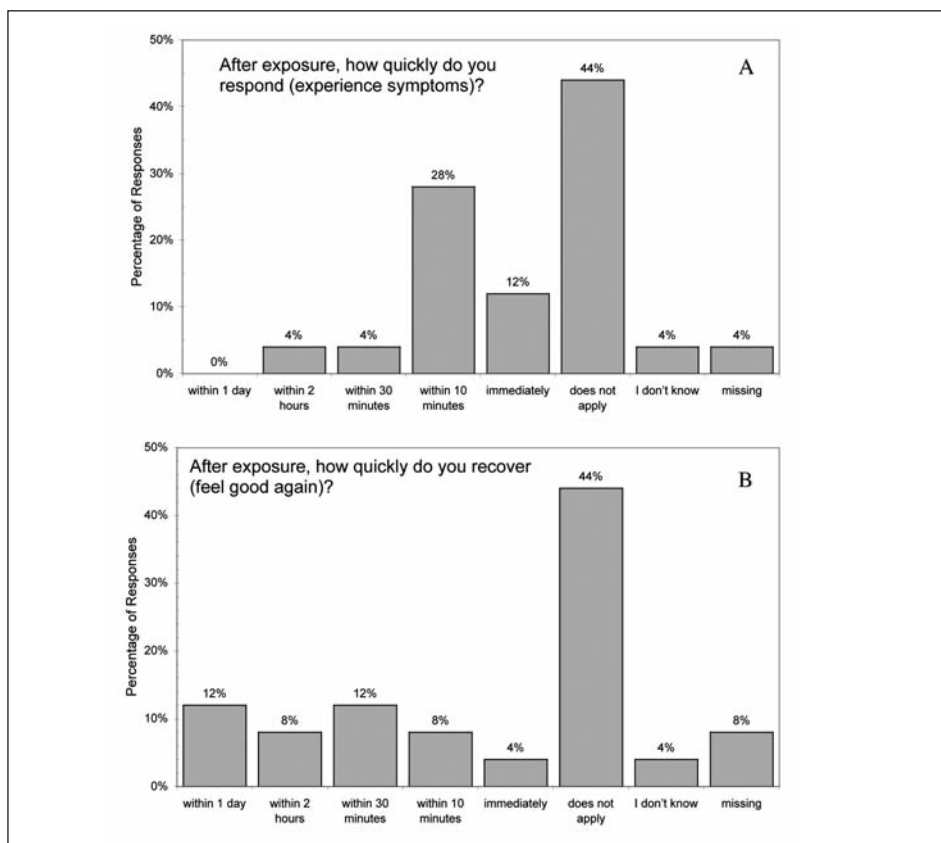

Fig. 5. Self-proclaimed response time of participants to electro-stress and recovery (n=25)

lighting in stores. Others have difficulty flying or traveling by car, perhaps due to microwave exposure on highways and in airplanes. A few subjects are unable to use mobile phones and computers and are unable to watch television. Some are unable to wear jewelry because it irritates the skin and/or watches because they often malfunction (fig. 7).

EHS and person's EMF

The body voltage, as measured by the potential difference between the subject and the electrical ground, differed at the two sites. Subjects at Golden had much higher values than those at Boulder. This was also the case for the high and low frequency electric field and for the HF and LF magnetic field (Table 3). Galvanic skin response was highly variable among subjects prior to testing and did not relate to either sensitivity or the environment. There was no association between any of the EMF measurements (body voltage, GSR, electric field or magnetic field) that we conducted prior to testing and EHS of the subjects tested. In a follow-up study it would be useful to monitor each person's EMF before, during, and after exposure.

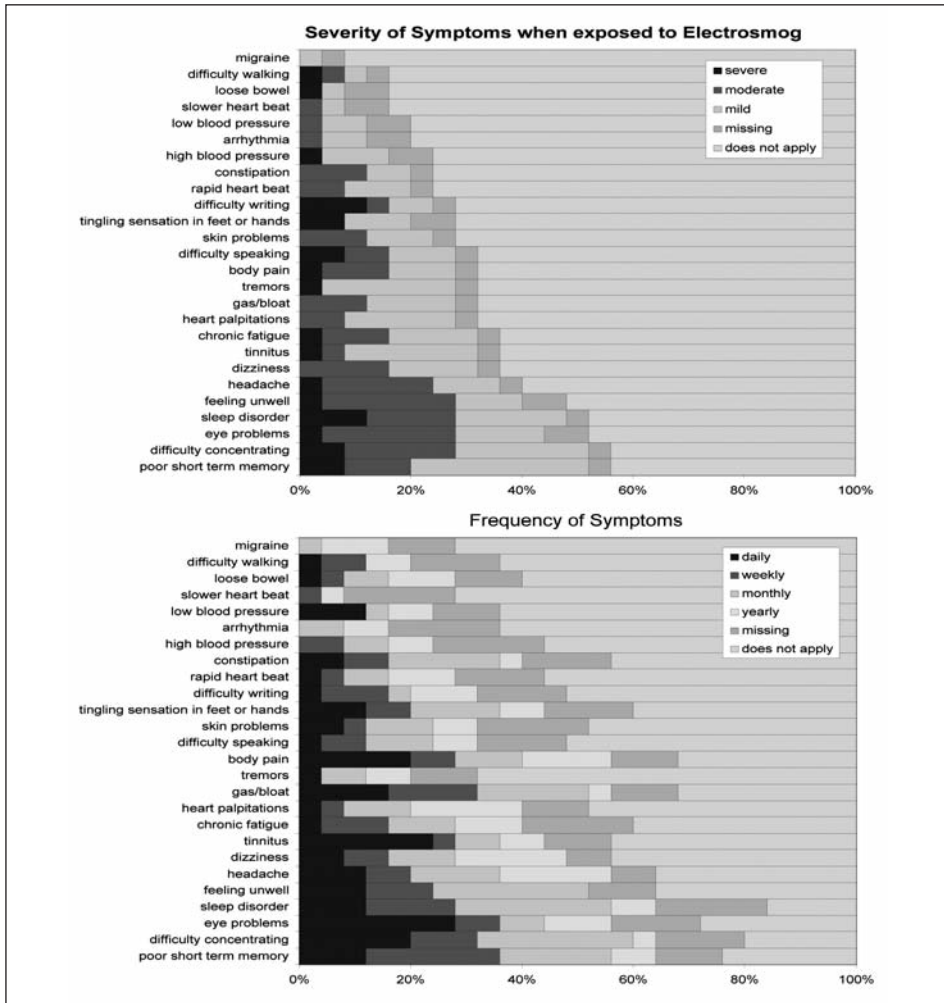

Fig. 6. Severity and frequency of symptoms associated with electrosmog exposure (n=25)

Blind assessment of responses: orthostatic HRV provocation HRV

The Orthostatic HRV provided us with the state of the ANS and the relative fitness score of the individual prior to exposure, which is important for predicting the intensity outcome of exposure.

A summary of the orthostatic HRV (blinded analysis) along with the self-assessment and the provocation HRV (blinded and unblinded) are provide in Appendix A for each subject. For those individuals who had either a moderate or intense response, the blinded predictions show good agreement for stage of exposure and for intensity of exposure.

Based on the orthostatic test, those with high adaptive capacity had a lower probability of reacting to stress, but if they did react, their reaction would be moderate to

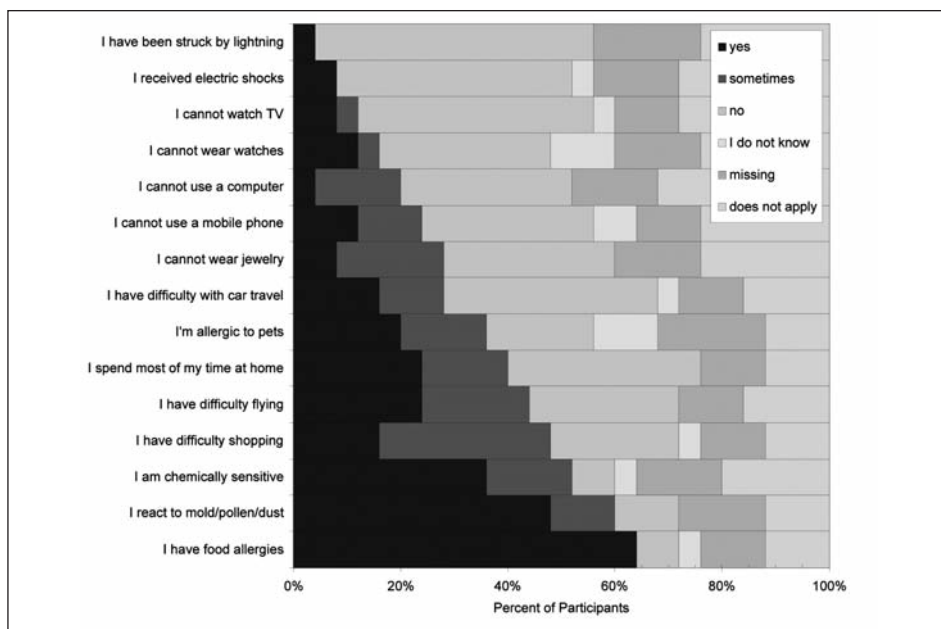

Fig. 7. Response to specific questions that may contribute to or be associated with electrical sensitivity (n=25)

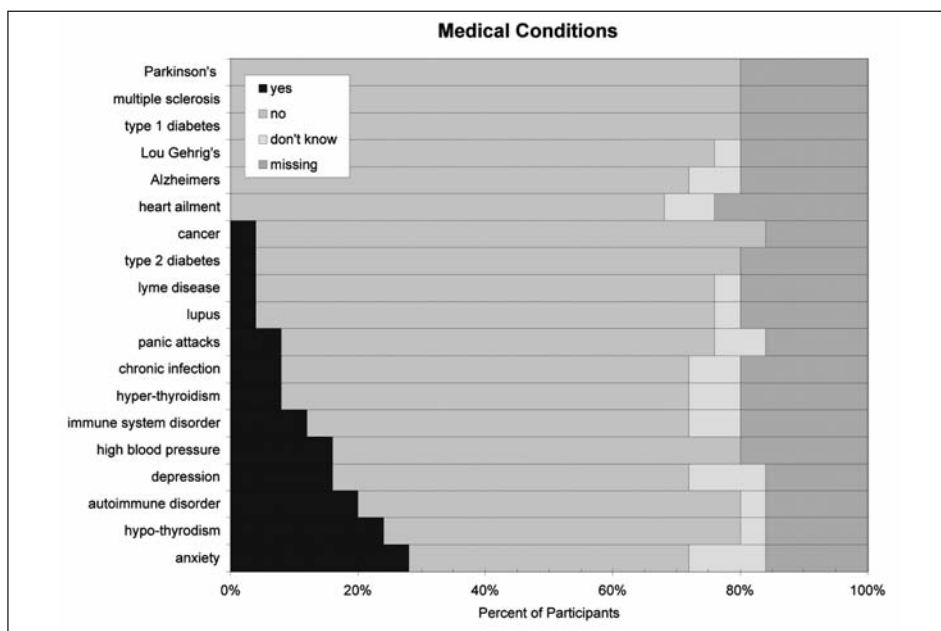

Fig. 8. Existing medical conditions of participants (n=25)

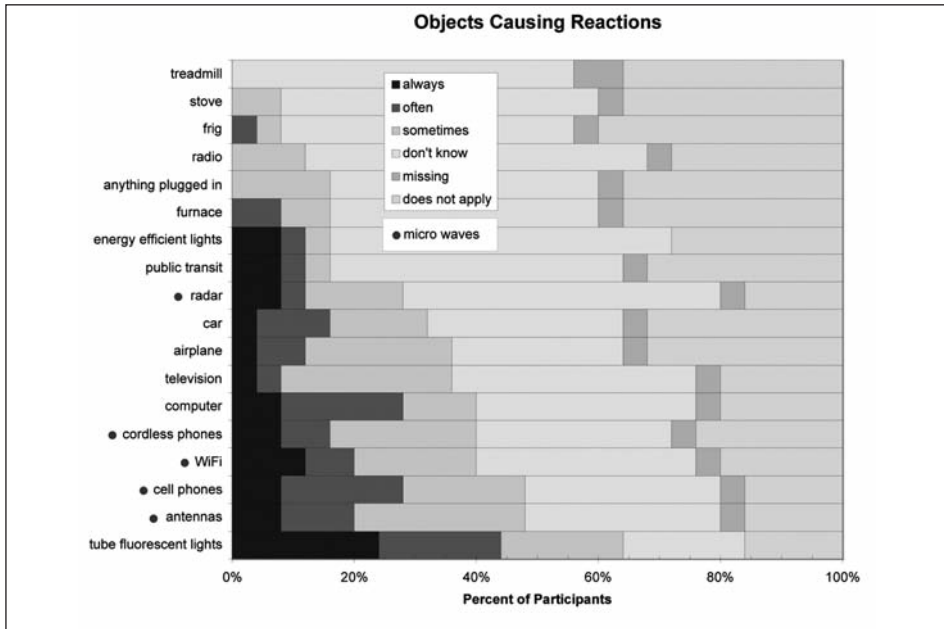

Fig. 9. Objects contributing to adverse health symptoms. Those marked with a dot generate microwave frequencies (n=25)

Table 3 - Personal electromagnetic environment (mean ± standard deviation) of subjects tested including galvanic skin response (GSR), body voltage, electric (E-field) and magnetic fields (M-field) at both high and low frequency (HF and LF) [* P ≤0.05].

Location	Date	GSR mV	Body Voltage mV	E-field HF mV	E-field LF mV	M-field HF mG	M-field LF mG
Golden	10/16/08	3.5 ± 1.8	3.4 ± 0.5*	88 ± 85*	333 ± 71*	4.6 ± 5.7*	17 ± 14*
Boulder	10/20/08	3.2 ± 2.5	0.5 ± 0.5	13 ± 33	63 ± 94	0.2 ± 0.6	2.7 ± 0.7*
Boulder	10/21/08	4.1 ± 1.3	0.2 ± 0.1	2 ± 0.8	57 ± 50	0.1 ± 0.4	1.7 ± 0.6*

intense. Conversely, those with low adaptive capacity had a higher probability of reacting but they didn't always have the energy to react and hence their reactions would be mild.

Provocation HRV

Most of the subjects (15/25, 60%) did not respond appreciable to the MW radiation generated by the cordless phone when it was plugged into a live outlet. The rhythmogram was unchanged and the heart rate, parasympathetic and sympathetic tone remained constant (figs. 3, 10, 12).

However, 10 subjects (40%) did respond to the MW challenge. Fig. 13 shows the response for six of those 10. Response and the recovery were immediate. MW provoca-

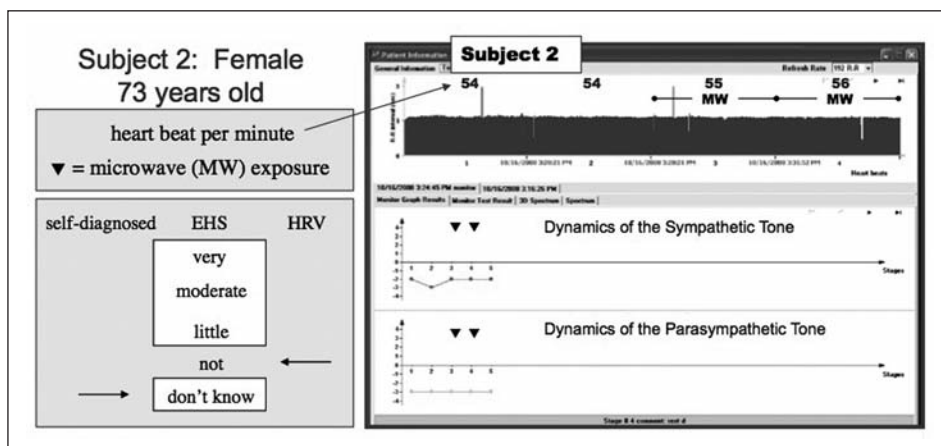

Fig. 10. Continuous monitoring of HRV during provocation part of this study for one subject who was non-reactive

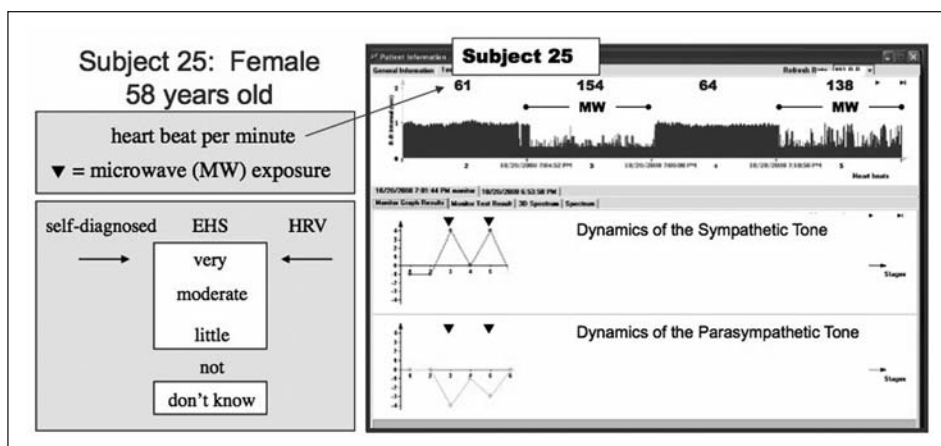

Fig. 11. Continuous monitoring of HRV during provocation part of this study for one subject who reacted to the MW radiation from a digital cordless 2.4 GHz phone

tion differed noticeably compared with sham exposure. Heart rate increased significantly for four of the subjects, resulting in tachycardia for three. The heart rate for subject 25 jumped from 61 bpm to 154 bpm (with real provocation) and returned to 64 bpm (with sham provocation) (fig. 11). The increase in heart rate was accompanied by up regulation of the SNS and down regulation of the PSNS during cordless phone exposure for four subjects in Table 4 (fig. 13). Response of the one subject (Subject 27) was paradoxical in that the heart rate increased from 72 to 82 bpm during which time the parasympathetic tone increased and the sympathetic tone remained constant.

Fig. 14 shows the range of responses of some non- or slightly reactive subjects to provocation.

Table 4 - Real-time monitoring of heart rate, sympathetic and parasympathetic tone before, during, and after exposure to a 2.4 GHz digital cordless phone radiating 3-5 microW/cm²

EHS	Subject Code	EHS Ranked	Heart Rate (bpm)				Sympathetic Response				Parasympathetic Response			
			bgrnd	pre	MW	post	bgrnd	pre	MW	post	bgrnd	pre	MW	post
Intense	25	1	61	61	154	64	-1	-1	4	0	0	0	-4	-1
	17	2	66	68	122	66	0	0	4	0	0	-2	-3	0
	26	3	59	61	106	61	-1	-1	3	0	1	2	-3	1
	27	4	72	nd	82	69	0	nd	0	0	-3	nd	2	-2
Moderate	5	5	66	66	66	65	1	1	3	0	-1	-1	-3	-1
	9	6	77	75	75	73	1	1	0	1	-2	0	-3	-1
	3	7	48	50	53	nd	2	-2	0	nd	2	0	0	nd
	16	8	61	nd	62	63	0	nd	-2	0	-2	nd	-2	-2
	8	9	81	nd	81	80	1	nd	1	1	0	nd	-2	-1
	10	10	69	68	70	70	0	0	0	0	-2	-2	-3	-1
Mild	2	11	54	54	55	56	-2	-3	-2	-2	-3	-3	-3	-3
	23	12	59	nd	58	60	-1	nd	0	-2	-2	nd	-2	-3
	12	13	71	nd	69	74	0	nd	1	0	-1	nd	-1	-1
	18	14	60	61	61	61	-2	-1	-2	-1	-3	-3	-3	-2
	19	15	63	62	62	61	-1	0	-1	-1	-3	-3	-3	-2
	6	16	65	66	66	65	0	0	0	0	-3	-3	-4	-3
	4	17	61	62	61	61	-2	-1	-1	-2	-3	-2	-3	-2
	24	18	71	72	71	69	0	0	0	0	-3	-2	-1	-2
None	1	19	71	70	71	71	0	0	0	1	-3	-1	-1	-1
	11	20	57	nd	57	58	0	nd	0	0	3	nd	3	2
	21	21	78	78	78	nd	1	1	1	nd	-2	-3	-3	nd
	7	22	70	71	70	69	0	0	0	0	-3	-3	-3	-3
	14	23	69	68	67	66	0	0	0	0	-1	-2	-2	-1
	20	24	67	nd	66	66	0	nd	0	0	-1	nd	-1	-1
	13	25	80	78	76	nd	1	1	1	nd	-3	-2	-2	nd
	Response		Mean Heart Rate (bpm)				Mean Sympathetic Response				Mean Parasympathetic Response			
	Intense		65	63	116	65	-0.5	-0.7	2.8	0.0	-0.5	0.0	-2.0	-0.5
	Moderate		67	65	68	70	0.8	0.0	0.3	0.4	-0.8	-0.8	-2.2	-1.2
	Mild		63	63	63	63	-1.0	-0.8	-0.6	-1.0	-2.6	-2.7	-2.5	-2.3
	None		70	73	69	66	0.3	0.4	0.3	0.2	-1.4	-2.2	-1.3	-0.8
	All		66	66	74	66	-0.1	-0.3	0.4	-0.2	-1.5	-1.7	-2.0	-1.4

Note:

EHS categories described in text: bgrnd = background; pre=sham exposure before real exposure; MW=microwave exposure; post=sham exposure after real exposure; nd=no data

The pre- and post-MW cordless phone response (SNS & PSNS) differed significantly for this group (fig. 15) with up regulation of the SNS and down regulation of the PSNS with MW exposure and the reverse for post-MW exposure suggesting a recovery phase.

The severe and moderate responders had a much higher LF/HF ratio than those who either did not respond or had a mild reaction to the MW exposure from the cordless phone (fig. 16B). This indicates, yet again, a stimulation of the SNS (LF) and a down-

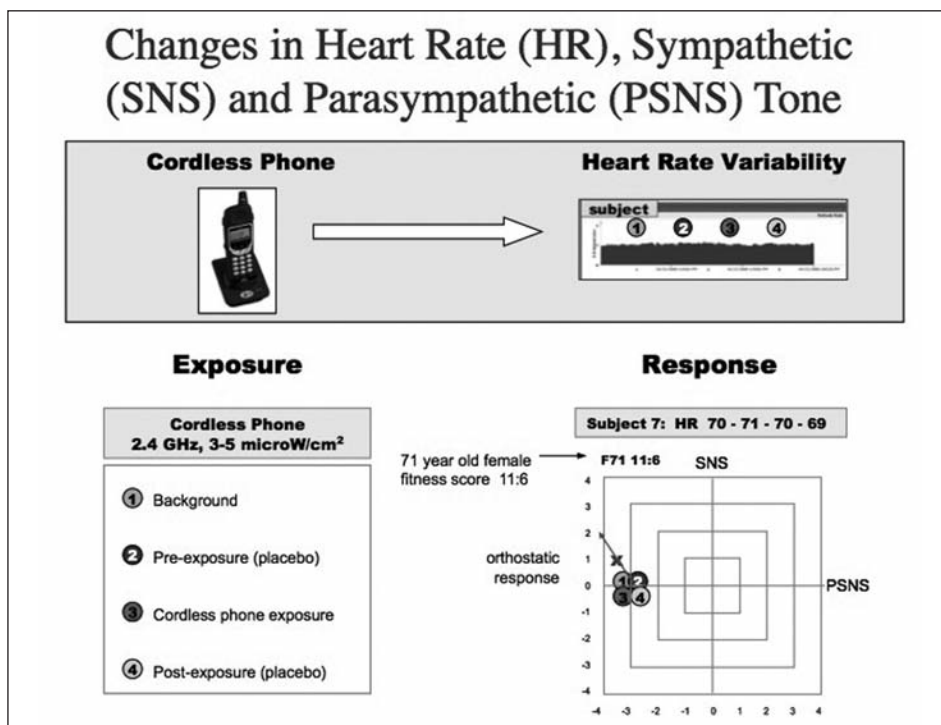

Fig. 12. Subject 7: no changes in heart rate, sympathetic, and parasympathetic tone before, during, and after blind provocation with a 2.4 GHz cordless phone generating exposure of 3 to 5 microW/cm²

regulation of the PSNS (HF). The up regulation was greater for LF2 than for LF1 (fig. 16A).

Based on self-assessment and the results from the provocation study, 2 subjects (8%) underestimated their sensitivity and 5 subjects (20%) overestimated their sensitivity to the cordless phone provocation. However, only two of the 5 claim to experience mild heart palpitations and only one of those responds “sometimes” to cordless phones.

Discussion

The most intriguing result in this study is that a small group of subjects responded immediately and dramatically to MW exposure generated by a digital cordless DECT phone with blinded exposure. Heart rate (HR) increased significantly for 4 subjects (16%) (10 to 93 beats per minute) and the sympathetic/parasympathetic balance changed for an additional 6 subjects (24%) while they remained in a supine position. This is the first study documenting such a dramatic change brought about immediately and lasting as long as the subject was exposed and is in sharp contrast to the provocation studies reviewed by Levallois³, Rubin *et al.*¹⁴, and Bergqvist *et al.*³¹. Authors of these reviews generally conclude that they were unable to establish a relationship between low or high frequency fields and electromagnetic hypersensitivity (EHS) or with symptoms typically occurring

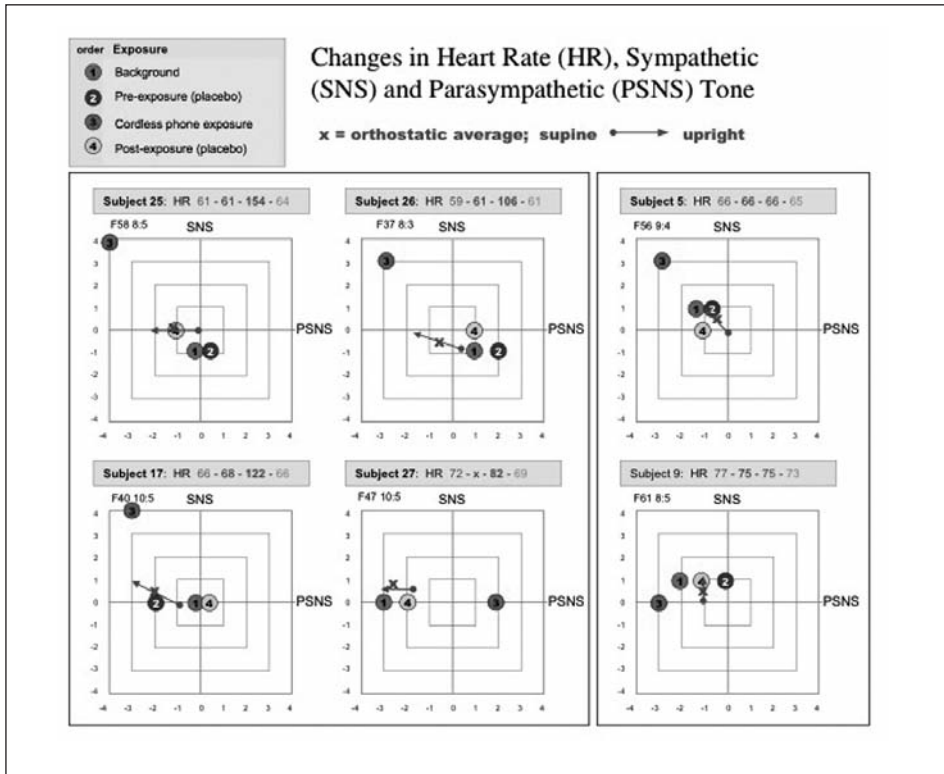

Fig. 13. Reactive Subjects: changes in heart rate, sympathetic, and parasympathetic tone before, during, and after blind provocation with a 2.4 GHz cordless phone that generates exposure of 3 to 5 microW/cm²

among such afflicted individuals. Furthermore, several studies report no effect of mobile phones (various exposure conditions) on human HRV-parameters³²⁻³⁹.

Our results clearly show a causal relationship between pulsed 100 Hz MW exposure and changes in the ANS that is physiological rather than psychological and that may explain at least some of the symptoms experienced by those sensitive to electromagnetic frequencies. Dysfunction of the ANS can lead to heart irregularities (arrhythmia, palpitations, flutter), altered blood pressure, dizziness, nausea, fatigue, sleep disturbances, profuse sweating and fainting spells, which are some of the symptoms of EHS.

When the SNS (fight or flight response) is stimulated and the PSNS (rest and digest) is suppressed the body is in a state of arousal and uses more energy. If this is a constant state of affairs, the subject may become tired and may have difficulty sleeping (unable to relax because of a down regulated PSNS and/or up regulated SNS). Interestingly, Sandstrom⁴⁰ found a disturbed pattern of circadian rhythms of HRV and the absence of the expected HF (parasympathetic) power-spectrum component during sleep in persons who perceived themselves as being electrically hypersensitive.

If the dysfunction of the ANS is intermittent it may be experienced as anxiety and/or panic attacks, and if the vagus nerve is affected it may lead to dizziness and/or nausea.

Our results show that the SNS is up regulated (increase in LF) and the PSNS is down regulated (decrease in HF) for some of the subjects during provocation. The greatest

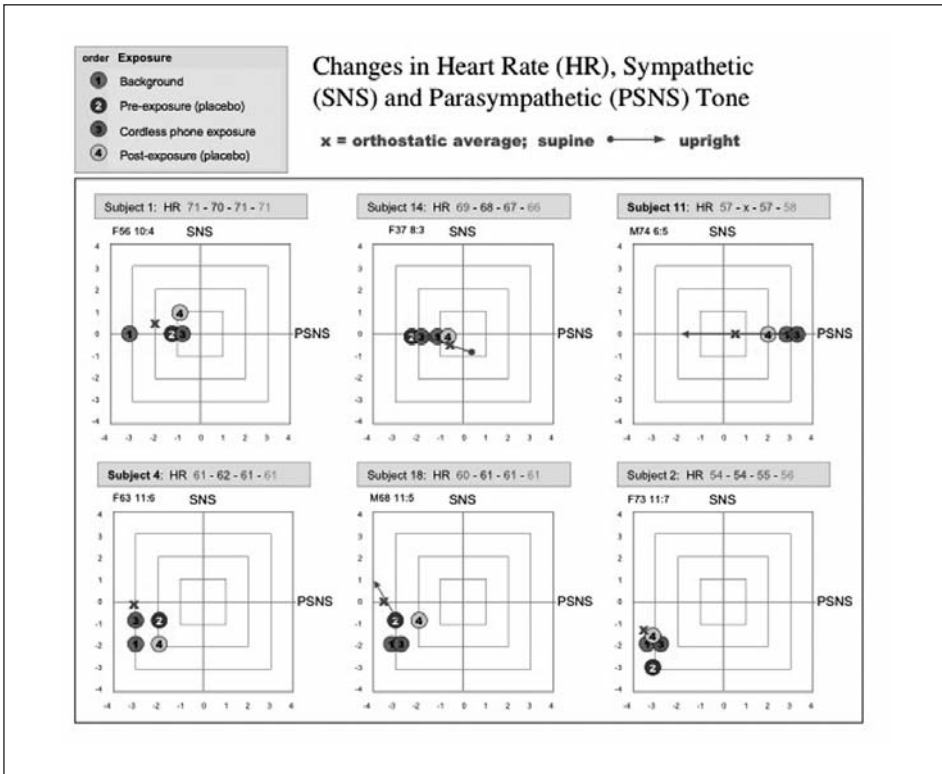

Fig. 14. Non or slightly reactive subjects: patterns of response for before, during, and after blind provocation with a 2.4 GHz cordless phone that generates exposure of 3 to 5 microW/cm²

increase is in LF2, which is the adrenal stress response, although LF1 also increases. We not know the degree to which this is due to the 100 Hz pulse, the MW carrier, or their combination.

Several studies lend support to our results.

Lyskov *et al.*⁴¹ monitored baseline neurophysiological characteristics of 20 patients with EHS and compared them to a group of controls. They found that the observed group of patients had a trend to hypersympathotone, hyper-responsiveness to sensor stimulation and heightened arousal. The EHS group at rest had on average lower HR and HRV and higher LF/HF ratio than controls. We found that subjects with intense and moderate reactions to the MW provocation also had higher LF/HF ratios than those who did not respond.

Kolesnyk *et al.*⁴² describes an “adverse influence of mobile phone on HRV” and Rezk *et al.*⁴³ reports an increase of fetal and neonatal HR and a decrease in cardiac output after exposure of pregnant women to mobile phones.

Andrzejak *et al.*⁴⁴ reports an increased parasympathetic tone and a decreased sympathetic tone after a 20-minute telephone-call. While these results are contrary to our findings, the effect of speaking cannot be ruled out in Andrzejak’s study. In our study the subject remained in a supine position, silent and still during the testing.

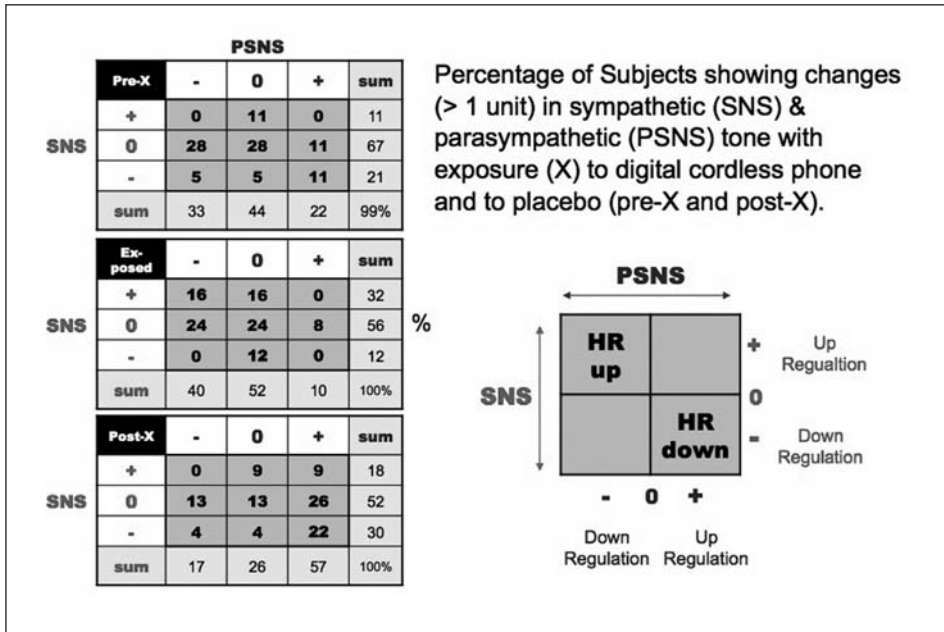

Fig. 15. Response of 25 subjects to blind provocation by a 2.4 GHz digital cordless phone that generates exposure of 3 to 5 microW/cm²

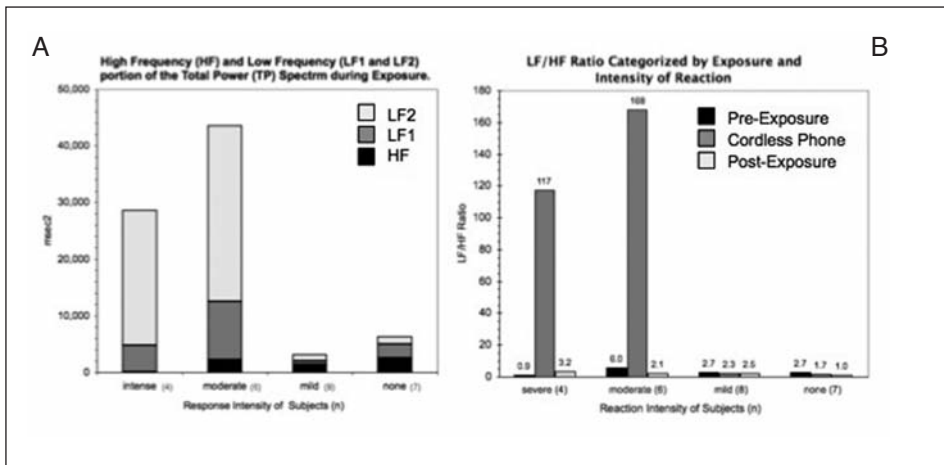

Fig. 16. A. Mean high frequency (parasympathetic) and low frequency (sympathetic) spectral distribution as a function of response intensity of 25 subjects exposed to a 2.4 GHz cordless phone. B. Low frequency (LF1 + LF2) to high frequency (HF) ratio for different exposures

Workers of radio broadcasting stations have an increased risk of disturbances in blood pressure and heart rhythm. They have a lower daily heart rate, a decreased HR variability, higher incidences of increased blood pressure and disturbances in parameters of

diurnal rhythms of blood pressure and HR-all of no clinical significance, but showing a certain dysregulation of autonomic cardiac control⁴⁵⁻⁴⁸.

Bortkiewicz *et al.*⁴⁹ reported that exposure to AM radio frequency EMF within hygienic standards affects the functions of the ANS of workers. Workers had higher frequency of abnormalities in resting and 24-h ECG than controls and an increased number of heart rhythm disturbances (ventricular premature beats). As in our study, RF exposure was associated with a reduced HF power spectrum suggesting that the EMF field reduce the influence of the PSNS on circulatory function.

Several studies report changes in blood pressure with electromagnetic exposure^{50, 51}. Others show an increase of oxidative stress and a decrease of antioxidative defense-systems in heart-tissue irradiated with 2.45 GHz and 900 MHz respectively^{52, 53}. Still others show a stress-response reaction following exposure to radio frequency radiation either in the form of heat shock proteins (hsp) or changes in enzymatic activity. Irradiation of rats with a low-intensity-field (0.2-20 MHz) resulted in an increase of myocardial hsp⁷⁰⁵⁴. Similarly 1.71 GHz MW exposure increased hsp70 in p53-deficient embryonic stem cells⁵⁵. Abramov and Merkulova⁵⁶ report pulsed EMFs increase the enzymatic activity of acetylcholinesterase in the animal heart, which suppresses the parasympathetic and allows the sympathetic to dominate.

Most of the studies on humans, that did not show any effects of MW radiation in some of the studies mentioned above, were conducted with young, healthy subjects, giving rise to the question whether the experiments would have yielded different results with subjects with a "higher level of pathologic pre-load" and thus fewer possibilities to acutely compensate the possible stressor of radiation.

The studies on work-exposure to MW radiation were able to show different levels of effects on the cardiovascular system, and this could be interpreted as the necessity to remain regularly, repeatedly, and for a longer time under the influence of a certain EMF exposure, hence pointing out the great importance of the electromagnetic exposures in the work and home environment. Perhaps only chronic exposure to MW-EMF can influence various rhythms (e.g. cardiovascular biorhythms) sufficiently to cause detectable effects. Perhaps it is these individuals who become EHS and then respond to stressors if they have sufficient energy to mount a reaction.

In our study, half of those tested claimed to be moderately to extremely sensitive to electromagnetic energy and they ranged in age from 37 to 79 years old. The symptoms they identified are similar to those reported elsewhere and include poor short-term memory, difficulty concentrating, eye problems, sleep disorder, feeling unwell, headache, dizziness, tinnitus, chronic fatigue, and heart palpitations^{2, 7, 57}.

The common devices attributed to stress generation included fluorescent lights, antennas, cell phones, Wi-Fi, and cordless phones. The last 4 items all emit MW radiation.

Many of those claiming to have EHS also had food allergies, mold/pollen/dust allergies and were chemically sensitive. With so many other sensitivities it is difficult to determine whether the sensitivity to electromagnetic energy is a primary disorder attributable to high and/or prolonged EM exposures or a secondary disorder brought about by an impaired immune system attributable to other stressors.

Interestingly, the younger participants (37 to 58) displayed the most intense responses presumably because they were healthy enough to mount a response to a stressor. Those who did not respond to the MW exposure were either not sensitive, or they had a low adaptive capacity coupled with a poor fitness score and did not have enough energy to

mount a reaction. Orthostatic HRV combined with provocation monitoring may help distinguish these three types of responses (sensitive, not sensitive, non-responsive reactors).

The term EHS was deemed to imply that a causal relationship has been established between the reported symptoms and EMF exposure and for that reason the WHO⁸ has labeled EHS as *Idiopathic Environmental Intolerance* (IEI) to indicate that it is an acquired disorder with multiple recurrent symptoms, associated with diverse environmental factors tolerated by the majority of people, and not explained by any known medical, psychiatric or psychological disorder. We think this labeling needs to be changed especially in light of this study.

Conclusions

The orthostatic HRV provides information about the adaptive capacity of an individual based on fitness score and on the state of the SNS and PSNS. A person with high adaptive capacity is unlikely to respond to a stressor (because they are highly adaptive) but if they do respond the response is likely to be intense. Orthostatic HRV was able to predict the intensity of the response much better than the probability of a response to a stressor, which in this case was a 2.4 GHz digital cordless phone that generated a power density of 3 to 5 microW/cm².

Forty percent of those tested responded to the HRV provocation. Some experienced tachycardia, which corresponded to an up regulation of their SNS and a down regulation of their PSNS (increase in LF/HF ratio). This was deemed a severe response when the HR in supine subjects increased by 10 to 93 beats per minute during blinded exposure. HR returned to normal during sham exposure for all subjects tested. In total, 16% had a severe response, 24% had a moderate response (changes in SNS and/or PSNS but no change in HR); 32% had a slight response; and 28% were non-responders. Some of the non-responders were either highly adaptive (not sensitive) or non-responding reactors (not enough energy to mount a reaction). A few reactors had a potentiated reaction, such that their reaction increased with repeated exposure, while others showed re-regulation with repeated exposure.

These data show that HRV can be used to demonstrate a physiological response to a pulsed 100 Hz MW stressor. For some the response is extreme (tachycardia), for others moderate to mild (changes in SNS and/or PSNS), and for some there is no observable reaction because of high adaptive capacity or because of systemic neurovegetative exhaustion. Our results show that MW radiation affects the ANS and may put some individuals with pre-existing heart conditions at risk when exposed to electromagnetic radiation to which they are sensitive.

This study provides scientific evidence that some individuals may experience arrhythmia, heart palpitations, heart flutter, or rapid heartbeat and/or vasovagal symptoms such as dizziness, nausea, profuse sweating and syncope when exposed to electromagnetic devices. It is the first study to demonstrate such a dramatic response to pulsed MW radiation at 0.5% of existing federal guidelines (1000 microW/cm²) in both Canada and the US.

Acknowledgements

We thank those who offered their homes for testing and those who volunteered to be tested. Special thanks goes to Evelyn Savarin for helping with this research.

References

1. Hallberg O, Oberfeld G. Letter to the Editor: Will we all become electrosensitive? *Electromagn Biol Med* 2006; 25: 189-91.
2. Firstenberg A. Radio wave packet. President, cellular phone taskforce. 2001; http://www.goodhealthinfo.net/radiation/radio_wave_packet.pdf
3. Eltiti S, Wallace D, Zougkou K, *et al.* Development and evaluation of the electromagnetic hypersensitivity questionnaire. *Bioelectromagnetics* 2007; 28: 137-51.
4. Hillert L, Berglind N, Arnetz BB, *et al.* Prevalence of self-reported hypersensitivity to electric or magnetic fields in a population-based questionnaire survey. *Scand J Work Environ Health* 2002; 28(1): 33-41.
5. Levallois P. Hypersensitivity of human subjects to environmental electric and magnetic field exposure: a review of the literature. *Environ Health Perspect* 2002; 110 (suppl 4): 613-8.
6. Johansson O. Electrohypersensitivity: State-of-the-art of a functional impairment. *Electromagn Biol Med* 2006; 25: 245-58.
7. Schooneveld H, Kuiper J. Electrohypersensitivity (EHS) in the Netherlands. A questionnaire survey. 2nd graphical edition. Stichting EHS (Dutch EHS Foundation), 2008, 23.
8. Mild KH, Repacholi M, van Deventer E (eds). *Electromagnetic Hypersensitivity*. Proceedings International Workshop on EMF Hypersensitivity Prague, Czech Republic October 25-27, 2004, 196.
9. Havas M, Olstad A. Power quality affects teacher wellbeing and student behavior in three Minnesota Schools. *Sci Total Environ* 2008; 402(2-3): 157-62.
10. Havas M. Dirty electricity: an invisible pollutant in schools. Feature Article for Forum Magazine, Ontario Secondary School Teachers' Federation (OSSTF), 2006; Fall.
11. Havas M. Electromagnetic hypersensitivity: biological effects of dirty electricity with emphasis on diabetes and multiple sclerosis. *Electromagn Biol Med* 2006; 25: 259-68.
12. Havas M. Dirty electricity elevates blood sugar among electrically sensitive diabetics and may explain brittle diabetes. *Electromagn Biol Med* 2008; 27(2): 135-46.
13. Rea WJ, Pan Y, Fenyves EJ, *et al.* Electromagnetic field sensitivity. *J Bioelectr* 1991; 10: 241-56.
14. Rubin GJ, Das Munshi J, Wessely S. Electromagnetic hypersensitivity: a systematic review of provocation studies. *Psychosom Med* 2005; 67: 224-32.
15. Santini R, Santini P, Danze JM. Study of the health of people living in the vicinity of mobile phone base stations: 1st influence of distance and sex. *Pathol Biol* 2002; 50: S369-73.
16. Granlund R, Lind J. Black on White: voices and witnesses about electro-hypersensitivity, the Swedish Experience. 2nd Internet Edition Oct 3, 2004. Translation: J. Ganellen; Diagrams: J. Rennerfelt © Mimers Brunn Kunskapsförlaget, Sweden. mimersbrunn@spray.se
17. IGUMED. Freiburger Appeal. nterdisziplinäre Gesellschaft für Umweltmedizin e. Bergseestr. Bad Sackingen, October 9 2002, 57, 79713. igumed@gmx.de
18. Haumann T, Sierck P. Nonstop pulsed 2.4 GHz radiation inside US homes. 2nd International Workshop on Biological Effects of Electromagnetic Fields, 7-11 Oct. 2002.
19. Singer DH, Martin GJ, Magid N, *et al.* Low heart rate variability and sudden cardiac death. *J Electrocardiol* 1988; 21: S46-55.
20. Cerutti S. Power spectrum analysis of heart rate variability signal in the diagnosis of diabetic neuropathy, IEEE Engineering in Medicine and Biology Society 11th Annual International Conference, 1989, 12-13.
21. Hayano J. Decreased magnitude of heart rate spectral components in coronary artery disease. *Circulation* 1990; 81: 1217-24.
22. Muhnlickel B. The value of heart rate frequency variability in the prognostic evaluation of patients with severe cerebral injuries. *Anaesthesiol Reanim* 1990; 15: 342-50.

23. Van Ravenwaaij-Arts CM, Kollee LA, Hopman JC, *et al.* Heart rate variability. *Ann Int Med* 1993; 118: 436-47.
24. Camm AJ, Malik M. Guidelines, heart rate variability, standards of measurement, physiological interpretation, and clinical use. Task Force of the European Society of Cardiology and the North American Society of Pacing and Electrophysiology. *Eur Heart J* 1996; 17: 354-81.
25. Riffine A. *Nervexpress*. System Guide and User's Manual. Heart Rhythm Instruments Inc., 2002, 72. Metuchen NJ. www.nervexpress.com.
26. Riffine A. Quantitative assessment of the autonomic nervous system based on heart rate variability analysis theoretical review of the nerve-express system with sample cases. *Theoretical Review and Clinical Use* 2005; 43 pp. www.intelwave.net
27. Graham MH. A microsurge meter for electrical pollution research. Memorandum No. UCB/ERL M03/3, 19 February 2003, Electronics Research Laboratory, College of Engineering, University of California, Berkeley.
28. NHLBI. High Blood Pressure. National Heart Lung and Blood Institute, Diseases and Conditions Index. November 2008. http://www.nhlbi.nih.gov/health/dci/Diseases/Hbp/HBP_WhatIs.html.
29. NHLBI. National Heart Lung and Blood Institute, Obesity Education Initiative, Calculate our Body Mass Index. No date; <http://www.nhlbisupport.com/bmi/>
30. Mortazavi SM, Daiee E, Yazdi A, *et al.* Mercury release from dental amalgam restorations after magnetic resonance imaging and following mobile phone use. *Pak J Biol Sci* 2008; 11(8): 1142-6.
31. Bergqvist U, Vogel E (eds). Possible health implications of subjective symptoms and electromagnetic fields. A report prepared by a European group of experts for the European Commission, DG V, Swedish: National Institute for Working Life, 1997; 135 pp.
32. Mann K, Röschke J, Connemann B, *et al.* No effects of pulsed high-frequency electromagnetic fields on heart rate variability during human sleep. *Neuropsychobiology* 1998; 38: 251-6.
33. Röschke J, Mann K, Connemann B. Cardiac autonomic activity during sleep under the influence of radiofrequency electromagnetic fields. *Somnologie* 2005; 9: 180-4.
34. Wilén J, Johansson A, Kalezić N, *et al.* Psychophysiological tests and provocation of subjects with mobile phone related symptoms. *Bioelectromagnetics* 2006; 27: 204-14.
35. Atlasz T, Kellényi L, Kovács P, *et al.* The application of surface plethysmography for heart rate variability analysis after GSM radiofrequency exposure. *J Biochem Biophys Methods* 2006; 69: 233-6.
36. Parazzini M, Ravazzani P, Tognola G, *et al.* Electromagnetic fields produced by GSM cellular phones and heart rate variability. *Bioelectromagnetics* 2007; 28: 122-9.
37. Barker AT, Jackson PR, Parry H, *et al.* The effect of GSM and TETRA mobile handset signals on blood pressure, catechol levels and heart rate variability. *Bioelectromagnetics* 2007; 28: 433-8.
38. Johansson A, Forsgren S, Stenberg B, *et al.* No effect of mobile phone-like RF exposure on patients with atopic dermatitis. *Bioelectromagnetics* 2008; 29: 353-62.
39. Ahamed VI, Karthick NG, Joseph PK. Effect of mobile phone radiation on heart rate variability. *Comput Biol Med* 2008; 38: 709-12.
40. Sandstrom M, Lyskov E, Hornsten R, *et al.* Holter ECG monitoring in patients with perceived electrical hypersensitivity. *Int J Psychophysiol* 2003; 49: 227-35.
41. Lyskov E, Sandström M, Hansson Mild K. Neurophysiological study of patients with perceived 'electrical hypersensitivity'. *Int J Psychophysiol* 2001; 42: 233-41.
42. Kolesnyk I, Zhulinsky M, Abramov VO, *et al.* Effect of mobile phone electromagnetic emission on characteristics of cerebral blood circulation and neurohumoral regulations in humans. *Fiziol Zh* 2008; 54: 90-3.
43. Rezk AY, Abdulqawi K, Mustafa RM, *et al.* Fetal and neonatal responses following maternal exposure to mobile phones. *Saudi Med J* 2008; 29: 218-23
44. Andrzejak R, Poreba R, Poreba M, *et al.* The influence of the call with a mobile phone on heart rate variability parameters in healthy volunteers. *Ind Health* 2008; 46: 409-17.
45. Bortkiewicz A, Zmylony M, Gadzicka E, *et al.* Evaluation of selected parameters of circulatory system function in various occupational groups exposed to high frequency electromagnetic fields. II. Electrocardiographic changes. *Med Pr* 1996; 47: 241-52.
46. Bortkiewicz A, Zmylony M, Gadzicka E, *et al.* Ambulatory ECG monitoring in workers exposed to electromagnetic fields. *J Med Eng Technol* 1997; 21: 41-6.
47. Gadzicka E, Bortkiewicz A, Zmylony M, *et al.* Evaluation of selected functional circulation param-

- eters of workers from various occupational groups exposed to electromagnetic fields of high frequency. III. 24-h monitoring of arterial blood pressure (ABP). *Med Pr* 1997; 48: 15-24.
48. Szmigielski S, Bortkiewicz A, Gadzicka E, *et al.* Alteration of diurnal rhythms of blood pressure and heart rate to workers exposed to radiofrequency electromagnetic fields. *Blood Press Monit* 1998; 3: 323-30.
 49. Bortkiewicz A, Gadzicka E, Zmylony M. Heart rate variability in workers exposed to medium-frequency electromagnetic fields. *J Auton Nerv Syst* 1996; 59: 91-7.
 50. Lu ST, Mathur SP, Akyel Y, *et al.* Ultrawide-band electromagnetic pulses induced hypotension in rats. *Physiol Behav* 1999; 65: 753-61.
 51. Li BF, Guo GZ, Ren DQ, *et al.* Electromagnetic pulses induce fluctuations in blood pressure in rats. *Int J Radiat Biol* 2007; 83: 421-9.
 52. Kim MJ, Rhee SJ. Green tea catechins protect rats from microwave-induced oxidative damage to heart tissue. *J Med Food* 2004; 7: 299-304.
 53. Ozguner F, Altinbas A, Ozaydin M, *et al.* Mobile phone-induced myocardial oxidative stress: protection by a novel antioxidant agent caffeic acid phenethyl ester. *Toxicol Ind Health* 2005; 21: 223-30.
 54. Ronchi R, Marano L, Braidotti P, *et al.* Effects of broad band electromagnetic fields on HSP70 expression and ischemia-reperfusion in rat hearts. *Life Sci* 2004; 75: 1925-36.
 55. Czyz, J, Guan K, Zeng Q, *et al.* High frequency electromagnetic fields (GSM signals) affect gene expression levels in tumor suppressor p53-deficient embryonic stem cells. *Bioelectromagnetics* 2004; 25: 296-307.
 56. Abramov LN, Merkulova LM. Histochemical study of the cholinesterase activity in the structures of the rat heart normally and during exposure to a pulsed electromagnetic field. *Arkh Anat Gistol Embriol* 1980; 79: 66-71.
 57. Bergqvist U, Wahlberg J. Skin symptoms and disease during work with visual display terminals. *Cont Derm* 1994; 30: 197-204.

APPENDIX A: Summary of data based on blind assessment.

1		2		3		4		5			6			7			Notes:
EHS	Subject Code	EHS Ranked	EHS Self Assessment	CV Tone	Orthostatic HRV			Actual Stages Exposed	Changes in			Blind Assessment Stages Exposed	Blind Assessment Stages showing reaction	POR Code	IOR		
					IOR Code	AC Code	POR Code		HR	SNS	PSNS						
intense	25	1	very	3	3.5	4.5	1.5	3, 5 (6, 7, 9)	93	5	-4	3, 5	3, 5	5	high to extreme	8	
	17	2	very	3	3.5	3.5	3.0	3, 5 (9)	54	4	-1	3, 5, 6	3, 5, 6	4.5	moderate	9	
	26	3	moderate	1	5.0	5.0	1.5	3, 5, 6 (7, 8)	45	4	-5	3, 5, 6, 7	3, 5, 6, 7	5	moderate to intense	10	
moderate	27	4	little	3	3.0	3.0	3.5	2, 4 (5, 6)	10	0	5	2, 4, 5	2, 4, 5	5	mild	11	
	5	5	moderate	2	4.0	3.5	3.5	3, 5	0	2	-2	3, 5	3, 5	5	moderate to high	12	
	9	6	don't know	2	3.5	4.5	2.0	3, 5, 6, 8	0	-1	-3	3, 5, 6	3, 5, 6	4	high	13	
mild	3	7	don't know	-1	5.0	4.0	1.0	3, 4	3	2	0	2, 3	3, 4	4	moderate	14	
	16	8	very	1	4.0	4.0	3.5	2, 4, 6	1	-2	0	2	2	1	mild	15	
	8	9	not	5	2.5	1.5	4.5	2, 3	0	0	-2	2, 4	2, 4	1	mild	16	
none	10	10	don't know	2	3.5	3.0	3.0	3 (7, 8, 9)	2	0	-1	3, 7, 8, 9	3 mild, 7, 8, 9 intense	5	intense	17	
	2	11	don't know	2	2.0	1.0	3.5	3, 4	-1	1	0	unknown	none	1.75	mild	18	
	23	12	little	-1	5.0	1.5	4.5	2, 4 (5, 6)	-1	1	0	2, 5	2, 5	2	mild to moderate	19	
mild	12	13	little	3	4.0	4.0	2.5	2, 3 (5)	-2	1	0	3	3, 4, 5	3	mild to moderate	20	
	18	14	don't know	2	2.5	2.5	4.5	3	0	-1	0	3	3	1.5	mild	21	
	19	15	don't know	4	2.0	2.5	3.0	3	0	-1	0	2, 4	2, 4	3	mild to moderate	22	
none	6	16	very	2	3.5	2.0	4.5	3, 4	0	0	-1	2	2	2	mild	23	
	4	17	little	1	2.0	1.0	4.0	3, 4	-1	0	-1	3, 4	4, 5	2.25	moderate	24	
	24	18	little	2	3.0	4.0	3.0	3, 5	-1	0	1	2, 4, 5	2, 4, 5	2.5	mild	25	
none	1	19	don't know	5	3.5	3.5	3.5	3, 4	1	0	0	3, 4	4, 5	1	mild	26	
	11	20	not	1	1.0	5.0	1.5	2, 4, 5	0	0	0	3	3	1	mild or non-symptomatic	27	
	21	21	little	3	2.5	2.0	3.5	3 (4, 5)	0	0	0	2, 5	2, 5	1.5	none to mild	28	
none	7	22	very	2	2.5	1.5	4.0	3, 4	-1	0	0	unknown	unknown	1.5	mild	29	
	14	23	don't know	5	2.5	3.5	3.0	3, 4	-1	0	0	2	2, 3, 4	1.75	mild	30	
	20	24	little	3	3.5	4.0	4.5	2	-1	0	0	possibly 5?	6	1	mild	31	
none	13	25	very	4	3.0	2.5	3.5	3, 4	-2	0	0	unknown	unknown	1	mild	32	

code	code	code	code	code	code	code	code
5	hypo	intense	high	high	high	high	intense
4		strong					strong
3	normal	moderate	moderate	moderate	moderate	moderate	moderate
2		mild					mild
≤1	hyper	don't know	low	low	low	low	don't know

Notes:

- 1 Electrohypersensitivity (EHS) response categories are based on HR = heart rate; SNS = sympathetic nervous system; PSNS = parasympathetic nervous system.
- 2 EHS was ranked based on changes in HR and changes in the SNS and PSNS during exposure to microwave (MW) radiation.
- 3 Self-assessment of sensitivity based on questionnaire response.
- 4 Cardiovascular (CV) Tone is based on the HR times the sum of the systolic and diastolic blood pressure; values at 1 or lower are hypotonic and values at 5 are hypertonic.
- 5 Intensity of reaction (IOR); adaptive capacity (AC), which is 6 - non adaptive capacity (NAC); and probability of reaction (POR) are based on the orthostatic heart rate variability (HRV) results and are described in the text.
- 6 Subjects were exposed to MW radiation at different stages. Stages in parentheses were not used in the study as they reflect multiple exposures with interference from other agents.
- 7 Blind assessment was based on the HRV during continuous monitoring with real and sham exposure to MW radiation from a 2.4 GHz digital cordless phone radiating and at a power density between 3 and 5 microW/cm².
- 8 Excellent subject.
- 9 Symptomatic at stage 3, parasympathetic rally begins to recovery but feels anxiety, stage 3 faint or dizziness predicted. Decent Chronotropic Myocardial Reaction Index (ChMR) and vascular compensation reaction (VC). Middle of bell curve.
- 10 The healthier a subject the more likely the reaction. This person has the energy to become symptomatic.
- 11 Mildly inflamed. Mildly fatigued but highly adaptive. ChMR and VC good. Has ability to react.
- 12 Adaptive person. Could use Mg and/or K based on high standing HR.
- 13 Has plenty of energy. Moderate response due to weakening. Stage 7 body re-regulating from exposure.
- 14 Shows a weakening reaction (down regulation of SNS). Positive reactor. Very healthy for age. Highly adaptive geriatric.
- 15 Lot of adaptive capacity. If she is exposed her reaction would be a fairly strong reaction.

- 16 Has diminished energy capacity (11:6). This person doesn't have enough energy to have a robust response.
- 17 Potentiated reactor, time sensitive, couldn't tolerate re-exposure. If she reacts it will be moderately strong because of ChMR. Needs minerals for VC factor slowed her down.
- 18 May be on heart medication. Cardiac rate and rhythm non-adaptive. CV tone hypertonic.
- 19 Any neurological insult will be met with a hard reaction since she has inverted response when she stands up.
- 20 If reactor, it will be strong because of ChMR strong. Highly adaptive capability and reserve. Slow VC could be mineral or vitamin D deficiency.
- 21 Don't have a strong PSNS resistance. Reactivity is based on inability to go parasympathetic, and then they will go more sympathetic if they have the energy to do so. No energy. Either a delayed reaction or a weak reaction.
- 22 Afibrillation, palpitations of heart probable. Strong girl. 11:6 fitness is OK for a person this age.
- 23 May have dental problems based on S/P response. Neurologically compromised.
- 24 Neurologically compromised. May be overmedicated on CV drug.
- 25 Strong gal. Decent reserve capacity but temporary fatigue. Doesn't feel bad but poor health for her age.
- 26 Normal reaction to stress, mild non-toxic reaction. Potential for reaction: moderately high because of the 10.4 but may tolerate an amount of exposure before they react because of the reserve capabilities.
- 27 Ridiculously healthy. Poster boy for his age. He can take a lot based on fitness of 6:5.
- 28 Lower end of bell curve. Doesn't have energy to react although may be symptomatic.
- 29 Either highly adaptive or non-reactive. Orthostatic response indicates that person doesn't have enough energy to have a robust response.
- 30 Normal CV tone for age, Decent Tension Index (TI). Good geriatric pattern. If she reacts it would be moderate to mild.
- 31 Strong girl. Has strong adrenal capacity. If she reacts it will be strong. May have chronic fatigue.
- 32 Moderate inflammation. Tired and has low adaptive reserve. If stressor comes along it will produce more stress. If reacting it would be medium.

Comparative assessment of models of electromagnetic absorption of the head for children and adults indicates the need for policy changes

Yueh-Ying Han*, Om P. Gandhi**, Alvaro DeSalles***,
Ronald B. Herberman****, Devra L. Davis*****

* Department of Epidemiology, Graduate School of Public Health, University of Pittsburgh, Pittsburgh, Pennsylvania, USA

** Department of Electrical and Computer Engineering, University of Utah, Salt Lake City, Utah, USA

*** Electrical Engineering Department, Federal University of Rio Grande do Sul (UFRGS), Porto Alegre, Brasil

**** Chief Medical Officer, Intrexon Corporation, Bethesda, MD, USA

***** Georgetown University, Science, Technology and International Affairs, School of Foreign Service, Washington DC, USA and Founder, Environmental Health Trust

Abstract

Globally more than four billion phones are in use, with more than half of all users believed to be children and young adults. Over the past two decades, models of the human head have been devised based on imaging studies and used to estimate the extent and rate of radiation energy absorption to the brain, the Specific Absorption Rate (SAR). IEEE and ICNIRP SAR recommendations rest solely on avoiding thermal effects on the adult male head under conditions of a six minute long call and do not take into account the long-term cell phone use, the length of calls, non-thermal biological effects, the smaller size and greater physiological vulnerability and increased absorption to the heads of children and females. Currently recommended approaches by the IEEE calculate peak spatial average SAR for safety compliance testing of cell phones based on a physical model of an adult male head with an added 10 mm plastic spacer to model the ear (pinna). By incorporating such a spacer, the IEEE model assumes that the RF energy absorption in the ear (or pinna) may be treated like extremities of the body such as the legs and the arms that are not proximate to the brain. The 10 mm spacer artificially results in 2 to 4 times lower exposures to the head. Recent epidemiologic studies of adults from those few nations where cell phone use has been extensive for a decade or longer indicate significantly increased risk of a variety of brain tumors. These findings, together with the limitations of currently used head models and the growing use of phones by the young and females, indicate a clear and compelling need for improved, biologically-based

models of the head in order to better estimate population-wide exposures of children and women to cell phones and provide the grounds for improved policies to reduce those exposures.

***Key Words:* health effects, mobile phones, Specific Absorption Rate (SAR), children and adults, radio frequency radiation, brain and cell phone.**

Introduction

Cell phone use has grown exponentially throughout the world in less than a decade. More than half of the world's population uses cell phones today as telephones as well as clocks, radio, video, and tools for exchanging information. Current technology of 2G and 3G phones operates in the microwave range, from 800 to 2450 megahertz (MHz). Standards for these phones rest on guidance developed by two non-governmental engineering-based groups, the Institute of Electrical and Electronics Engineers (IEEE) and International Commission on Non-Ionizing Radiation Protection (ICNIRP)^{1, 2}. For compliance with IEEE and ICNIRP exposure limits, the quantification of exposure to the head, the 1 or 10 gram (g) Specific Absorption Rates (SAR), is based on a physical model of an adult male head with a 10 mm spacer at the ear, or pinna, to estimate radiofrequency (RF) thermal energy absorption that can take place in the course of a call with no accounting for the duration of the call assuming that it will not result in change in temperature of the brain. In the U.S., Canada, and most industrial nations, there is no independent review of these standards, monitoring of the cell phone manufacturers for compliance with these standards, or monitoring of cell phone use in real life.

A growing number of *in vitro* and *in vivo* studies have confirmed that both 2G and 3G signals at non-thermal levels are genotoxic^{3, 4}. Potential mechanisms of such impact include changes in free-radical formation, alterations in electron conformation, and inhibition of proteins and other factors involved in DNA repair and synthesis. While molecular mechanisms for possible adverse effects have not been completely elucidated, energy absorption of higher frequency signals emitted by recently developed 3G, or even the new generation 4G cell phones, may result in greater biological effects. Based on these considerations, a growing number of national governmental agencies have issued precautionary advisories, urging that children avoid regular use cell phones next to their heads, restricting the marketing and development of cell phones for children, and recommending general methods for reducing direct exposure to the head of adults⁵.

To complement such general precautions, this paper briefly reviews the underlying engineering and biology of RF signals associated with different generations of phones, synthesizes evolving evidence on the health effects of RF, clarifies and considers the strengths and limits of currently used models of the head used for testing phones, and summarizes efforts to promote precaution regarding the use of phones.

The changing nature of RF cell signals

Over the past four decades, cell phone types and uses have radically changed. The first generation, known as 1G, was a bulky cell phone introduced in the 1980s based on analog modulation with output power typically around 2 to 3 Watts (W). Examples of these systems are the Advanced Mobile Phone System (AMPS) in North America, Asia

Pacific, Russia, Africa and Israel in the frequency band between 800 and 900 MHz, and the Nordic Mobile Telephone (NMT) 900 system since 1986 in Scandinavia, Netherlands, Switzerland and Asia. The RF from 1G phone was presumed to produce mainly thermal effects, with any potential risks resulting from heating of the tissues.

The advanced generations of cell phones, namely 2G and 3G, employ higher data rates and a broader range of multimedia services and were launched in 1991 and 2001. Unlike 1G cell phones, the maximum radiated power was now controlled by the base station (cell tower or mast). The base station reduced the power emitted by 2G and 3G cellphones to a level that produces a good signal to noise ratio (SNR). These phones rely on digital modulation with mean (rms) output power typically around 250 or 125 mW (maximum 1-2W). Typical examples of these systems are: the North American Digital Cellular (NADC) system (824-894 MHz) since 1991 in USA; the Personal Communication Services (PCS) system (1850-1990 MHz) since 1996 in USA; the Global System for Mobile Communications (GSM) system (880-960 MHz) since 1991 in Europe and Asia Pacific; and the Digital Cellular System (DCS) 1800 (1710-1880 MHz) employed since 1993 in Europe. The modulation signals used in these digital systems are complex with the lowest rate of 217 Hz (e.g., GSM is encoded at 217 pulses/sec). This lower rate was reported to result in greater interaction with the biological tissues, inducing non-thermal effects and increased risks to living cells, even at low absorbed average powers⁶. Current 3G and 4G phones involve modulation with even lower minimum pulse rates and much higher data rates. As a result, 3G phones can result in greater cumulative average exposures, a result of the higher data rates.

Most contemporary cell phones use monopole or helix type antennas, which produce similar radiation patterns. The radiation pattern determines how the energy is distributed in the space. This can be represented by two planes that are orthogonal to each other, one is the electric field, the other is the magnetic field. When a monopole or helix antenna rests in a vertical direction and is unimpeded by any RF absorbing obstacle like the human head or body, it produces a nearly symmetrical pattern of RF around this antenna. In actual use about one half of the RF energy radiated by a cell phone is absorbed by the human head. The closer the cell phone is to the head the greater is the absorbed energy in the head tissues.

Biologic effects of non-ionizing radiation

Ionizing radiation (IR) is well known to have potent biological effects that break chemical bonds creating ions. This breakage of bonds results in diseases ranging from cancer to developmental and reproductive impairment, to death.⁷ These biological impacts arises because 15% of the IR directly breaks ionic bonds at the backbone of DNA causing mutations that can lead to cancer; 85% of IR damage is caused by the creation of free radicals in the cell's cytoplasm near the DNA molecule, also resulting in DNA mutations, or through other mechanisms that are still being elucidated.

Non-ionizing radiation (NIR), found at all frequencies with energy levels too low to break chemical bonds from low-frequency electric power systems to microwave (MW) frequencies used by cell phones also produces biological effects when studied in cell cultures and in experimental animals. At low levels, equivalent to exposure from radiation from mobile phones, RF has been shown to result in damage to biological tissues, including both single and double DNA strand breaks, alterations in the permeability of

the blood-brain barrier (BBB), oxidative stress, and damage to neural cells of the brain^{8,9}.

Two mechanisms have been identified thus far to explain the variety of non-ionizing electromagnetic fields (EMFs) interactions with biological systems: thermal effects and non-thermal effects. Thermal effects arise directly from the increased movement of molecules results in tissue heating as a result of the absorption of EMFs in a dissipative medium. Absorption of energy at MW/RF frequencies is largely due to the motion of water dipoles and dissolved ions. At high frequencies (such as for the MW/RF band), tissues with high water content, such as occurs in the brains of young children, show electrical conductivity increasing with frequency. Thus, the net thermal response of the body will vary depending on SAR, ambient temperature, clothing, thermoregulatory system and physiological condition.

Non-thermal effects can result from direct interaction of the MW/RF fields on molecules or tissue components, changing electron conformation, altering stress proteins (previously known as heat shock proteins), immune-system function and having other impacts that remain to be clarified. Non-thermal effects are still not very well understood and their exact consequences on human health are still being investigated. Some reported non-thermal effects on tissue are biochemical and electrophysiological effects and can result in changes in the nervous, immune and cardiovascular systems, as well as in metabolism and hereditary factors^{4,10,11}.

In a pioneering research effort that created the widely used Comet Assay, Lai and Singh demonstrated that two hours of microwave radiation, comparable to that emitted by a cell phone, damaged DNA of the rat brain¹². A European study team of a dozen collaborators under the aegis of REFLEX [Risk Evaluation of Potential Environmental Hazards from Low Energy Electromagnetic Field (EMF) Exposure Using Sensitive *in vitro* Methods], found evidence that low (non-thermal) energy levels of RF exposure induced double strand breaks in DNA of cells exposed to between 0.3 and 2 W/kg¹³. Although the mechanism(s) underlying such non-thermal effects of NIR remains unclear, it seems quite plausible, as with the cancer-promoting effects of inflammatory lesions, that mutagenic damage to DNA could be induced by generated free radicals. In contrast, many other studies of non-thermal or thermal effects of RF issue have yielded no evidence of DNA damage. But, the great preponderance of these negative studies have not reflected independent research but resulted from studies directly funded by the cell phone industry¹⁴.

Current SAR calculations rest solely on avoiding thermal impacts. In principle, as the newer generation of digital phones radiate lower mean power in comparison to the analogue phones, the risk associated with the heating of tissues should be correspondingly reduced. However, most mobile communication systems are pulse-like in nature and modulated at low frequencies with high data rates. As a result, these newer systems can induce low-levels of currents in the brain tissues that have been linked with a variety of non- or thermal effects, e.g., BBB alterations, single and double strand DNA breaks, chromosomal aberrations, etc., at RF energy levels substantially below the thermal threshold.

Despite the growing industry-independent evidence that NIR has a range of biological impacts, intense controversy surrounds the interpretation of the limited available public health investigations regarding risk for cancer or other chronic diseases. Human studies on both cancer and non-cancer impacts of NIR are inconsistent for reasons that have been thoroughly discussed by a number of authors¹⁵.

Epidemiologic studies

The biology and epidemiology of the often lethal cancer of the brain is complex. It is unreasonable to expect to be able to detect an increased risk of brain tumors in less than a decade, because brain tumors are known to have latencies that can be between a decade to four decades long¹⁶. Recently several authors have produced meta-analyses that show that only when studies have followed people for a decade is there evidence of increased risk (Table 1).

For more than a decade, Hardell and his colleagues conducted a series of studies in Sweden, a country where proportionally more of the population has heavily used cell phones for a longer period of time than in many other industrialized nations. Regarding acoustic neuroma (AN), the Swedish group reported an 2.7 to 5.1 fold increased risk of AN for those regularly using an analog cell phone for five years or more compared to those who never or rarely used a cell phone^{17, 29}. Hardell's team also found long-term analogue cell phone use significantly increased the risks of meningioma and astrocytoma^{22, 29}. Recently, Hardell and Carlberg found that persons who had used cell phones for 10 years or more also had the highest risk for astrocytoma. This study also included persons who had begun to use cell phones before age 20. Cases with first mobile phone use younger than 20 years age had five times more brain cancer for 1 or more years of use (OR=5.2, 95% CI=2.2-12). For AN, the highest risk was found for greater than 10 years of ipsilateral mobile phone use (OR=3.0, 95% CI=1.4-6.2)³⁰.

The International Agency for Research on Cancer (IARC) began an international collaborative case-control study on cell phone use and the incidence of brain tumors in 13 countries in 1997 (the INTERPHONE study). Among six INTERPHONE reports from different countries, which included persons who had used phones episodically for less than a decade, none reported a relationship between cell phone use and AN^{18-20, 31-33}. They did not report any significant relationship between long term cell phone use and glioma, meningioma or other brain tumors^{21, 24, 25, 27, 28}. However, the recently published Interphone study found that the heaviest cell phone users, cumulative call time ≥ 1640 hours have increased risk of glioma (OR=1.40, 95% CI=1.03-1.89) and meningioma (OR=1.15, 95% CI=0.81-1.62)³⁴. Brain tumor risk was not found to be higher among those who use cell phone less frequently.

The lack of an observed association between published studies of cell phone use and risk for malignant or benign tumors in other published studies could reflect a number of methodological limits of study design. Most of these negative studies involved relatively short time periods of cell phone use, infrequent use of cell phones, or a small number of cases. In an effort to refine evaluation of the issue, studies have been carried out that separate out extent and type of cell phone use, including side of the head on which phones are typically used. The Hardell group found a consistent pattern of an association between ipsilateral AN and cell phone use providing that there was a 10-year latency period or longer (OR=2.4, 95% CI = 1.1-5.3)²³. Two additional studies from other investigators in the Nordic region^{19, 20} produced similar results. A study used interphone protocol that pooled data from 5 North European countries similarly found an increased glioma risk after a decade of use for ipsilateral cell phone exposure (OR=1.4, 95% CI=1.0-1.9)³⁵. A significant excess risk for reported ipsilateral phone use to the tumor was also found for glioma regardless of the duration of cell phone use²⁶.

A recent meta-analysis of studies produced by a team from California and Korea has corroborated this analysis, noting that the Hardell's work consistently reflects high

Table 1 - Summary of published articles on brain tumors and long term (≥ 10 years) cell phone use

Study	Population	Period	Study type	No. cases	No. controls	OR (95% CI)	Cell phone exposure
Acoustic Neuroma							
Hardell <i>et al.</i> , 2002 ¹⁷	Sweden	2000-2002	Case-control	46	26	1.8 (1.1-2.9)	regular analogue phone use
Christensen <i>et al.</i> , 2004 ¹⁸	Denmark	2000-2002	Case-control	2	15	0.2 (0.04-1.1)	regular use
Lönn <i>et al.</i> , 2004 ¹⁹	Sweden	1999-2002	Case-control	14	29	1.8 (0.8-4.3)	regular use
				12	15	3.9 (1.6-9.5)	ipsilateral exposure
Schoemaker <i>et al.</i> , 2005 ²⁰	4 Nordic countries and UK	1999-2004	Case-control	47	212	1.1 (0.7-1.5)	regular use
				23	72	1.8 (1.1-3.1)	ipsilateral exposure
Schüz <i>et al.</i> , 2006 ²¹	Denmark	1982-2002	Cohort	28	42.5	0.7 (0.4-1.0)*	regular use
Hardell <i>et al.</i> , 2006 ²²	Sweden	1997-2003	Pooled case-control	19	84	2.2 (1.4-3.8)	regular analogue phone use
				1	18	0.6 (0.1-5.0)	regular digital phone use
Hardell <i>et al.</i> , 2008 ²³	Sweden		Meta-analysis	83	355	1.3 (0.6-2.8)**	regular use
				53	167	2.4 (1.1-5.3)****	ipsilateral exposure
Glioma							
Christensen <i>et al.</i> , 2005 ²⁴	Denmark	2000-2002	Case-control	6***	9	1.6 (1.4-6.1)	regular use
Lonn <i>et al.</i> , 2005 ²⁵	Sweden	2000-2002	Case-control	22	33	0.9 (0.5-1.6)	regular use
				14	15	1.8 (0.8-3.9)	ipsilateral exposure
Hepworth <i>et al.</i> , 2006 ²⁶	UK	2000-2003	Case-control	48	67	1.1 (0.7-1.7)	regular use
Schüz <i>et al.</i> , 2006 ²⁷	Germany	2000-2003	Case-control	12	11	2.2 (0.9-5.1)	regular use
Lahkola <i>et al.</i> , 2008 ²⁸	5 European countries		Case-control	143	220	0.9 (0.7-1.3)	regular use
				77	117	1.4 (1.0-1.9)	ipsilateral exposure

(continued)

Table 1 - Summary of published articles on brain tumors and long term (≥ 10 years) cell phone use

Study	Population	Period	Study type	No. cases	No. controls	OR (95% CI)	Cell phone exposure
Meninglioma							
Lönn <i>et al.</i> , 2005 ²⁵	Sweden	2000-2002	Case-control	8	32	0.7 (0.3-1.6)	regular use
				4	15	1.4 (0.4-4.4)	ipsilateral exposure
Christensen <i>et al.</i> , 2005 ²⁴	Denmark	2000-2002	Case-control	6	8	1.0 (0.3-3.2)	regular use
Hardell <i>et al.</i> , 2006 ²²	Sweden	1997-2003	Pooled case-control	34	84	1.6 (1.0-2.5)	regular analogue phone use
				8	18	1.3 (0.5-3.2)	regular digital phone use
Schüz <i>et al.</i> , 2006 ²⁷	Germany	2000-2003	Case-control	5	9	1.1 (0.4-3.4)	regular use
Lahkola <i>et al.</i> , 2008 ²⁸	5 European countries		Case-control	42	130	0.9 (0.6-1.3)	regular use
				21	73	1.0 (0.6-1.7)	ipsilateral exposure
Astrocytoma							
Hardell <i>et al.</i> , 2006 ²⁹	Sweden	2000-2003	Case-control	40	40	3.7 (2.0-7.0)	regular analogue phone use
				16	18	2.2 (0.8-6.5)	regular digital phone use
All Malignant Brain Tumor							
Hardell <i>et al.</i> , 2006 ²⁹	Sweden	2000-2003	Case-control	48	40	3.5 (2.0-6.4)	regular analogue phone use
				19	18	3.6 (1.7-7.5)	regular digital phone use

* Standardized incidence ratio was calculated based on observed and expected numbers

** Based on 4 case-control study (Lönn et al 2004, Christensen et al. 2004, Schoemaker et al. 2004, and Hardell et al., 2006)

*** Results from a Meta-analysis, based on three case-control studies (Lönn et al., 2004, Schoemaker et al., 2005 and Hardell et al., 2006)

**** low-grade glioma

quality methods and design. The researchers examined 465 articles published in major journals and focused on 23 studies involving 37,916 participants. In eight of the studies – those that were conducted with the most scientific rigor – cell phone users were shown to have a 10% to 30% increased risk of all types of tumors studied compared with people who rarely or never used cell phones (OR=1.2, 95% CI=1.0-1.3). The risk was highest among those who had used cell phones for 10 years or more³⁶.

The results of the entire literature on epidemiology and cell phone use remain controversial, because most studies suffer from a number of methodological shortcomings including: insufficient statistical power to detect an excess risk of brain tumors; reliance on small populations; short-term exposure periods; problems in recollection of past practices and difficulty in characterizing changing exposures throughout a lifetime in large populations. As a number of researchers have suggested, retrieving billing records from cell phone network providers to obtain cumulative duration and frequency of cell phone use and corroborating personal interview would provide the capability to validate self-reported cell phone exposure in future studies³⁷. Assuring independent funding for future research will also be critical, given the widely reported biases associated with the design and interpretation of industry-funded studies to date.

Regarding short-term health impacts from RF exposure such as insomnia, impairment of short-term memory, headache, alteration of EEG and other behavioral problems, evidence has been fairly consistent that such effects are worsened in longer term cell phone users^{38,39}. Whether these relatively benign perturbations signal the likelihood that more serious health impacts will occur after longer-term RF exposure is a matter of critical importance for future studies.

Models of the head used to evaluate compliance with safety standards

Given the concerns that have been raised from the biological and epidemiological studies, it is important to establish standards for RF exposures from cell phones that incorporate the best scientific information regarding differences in the heads of people of various sizes, genders and ages. Children's skulls are thinner and their brains are less dense and more fluid, making them more vulnerable than adults to RF signals. Size alone affects absorption. In addition, other physiological properties such as permittivity, electrical conductivity and density also affect transmission and absorption of RF signals, as does myelination of the nerves of the brain, which is not complete until the early to mid-twenties⁴⁰.

The relative permittivity of a material under given conditions is measuring the extent to which it concentrates lines of flux. The relative permittivity of any material is expressed as the ratio of the amount of stored electrical energy when a potential is applied, relative to the permittivity of the vacuum. The relative permittivity or dielectric constant of the air is 1, while that of an adult brain is around 40 and that of a young child's brain is higher closer to 60 to 80⁴¹. This means that peak SAR in a child's head may be 50% to 100% higher than that for an adult⁴².

Conductivity and absorption of RF signals are a function of the dimensions and dielectric properties of the tissues that are directly exposed, as well as their neural density, with nerve cells being much more active than bone, hair, or skin. Conductivity is a parameter relating the electric field to the current density. For the same intensity of electric field, the increase in the conductivity will increase the current density and the

SAR. The absorption of RF energy will then increase, resulting in greater electromagnetic dissipation. Based on the measurements described by Peyman *et al*, the permittivity and the conductivity in the children's head tissues are estimated to be around 20% greater than in adults^{41, 43, 44}.

The combination of both effects, the increase in the concentration of the electric field due to the increase in the electrical permittivity together with the increase of dissipation of RF/MW energy due to the increase in the conductivity, can result in a substantial SAR increase in the children's head in comparison to the adults.^{42, 43}

The weight and size of the tissue being used for estimating the SAR will also affect assessments, with exposures averaged over 1 gram of the head being more stringent than those averaged over 10 grams of the whole body, as the latter involves bone and tissue of more varying electrical conductivities and mass densities than the former. The process of myelination of the brain protects nerves from damage by surrounding them with myelin sheaths, with myelination incomplete until the MID-205 could be yet another factor of concern for children and young adults using cellphones.

Recently, the use of cell phones by young and children has been modeled through a variety of simulations; some based on magnetic resonance imaging (MRI) others based on computerized tomography (CT) scans. Some studies have produced SAR simulations for the heads of adults^{45, 46}, while others took children into consideration⁴²⁻⁴⁴. A range of results was obtained (Table 2). In the Utah Model⁴⁷, the children's head was based on a scaled adult model and a SAR increase (compared with adult) of up to 153% was obtained.

In Schonborn's study, the head model was based on MRI using similar electromagnetic parameters as those for adults, and no significant differences between adult and children SAR results were observed⁵⁴. In another study, the head model was approximated by spheres considering some variation of the electromagnetic parameters, and an increase of around 20% in the calculated SAR was shown⁵⁵.

Using a scaled model for the children's head with adult electromagnetic parameters, no significant variation for the average SAR in the whole head was observed, and when considering the brain, an increase of around 35% in the SAR was calculated⁵¹. In De Salles's study, a 10 year old child head was developed based on CTI from a healthy boy⁴³. The physical and the electromagnetic parameters, such as the permittivity, the equivalent conductivity and the density were fitted to this age. SAR results around 60% higher than those simulated for the adults were observed for the children with fitted parameters.

Wiert and his colleagues developed child head models based on MRI. The combined results of these studies indicate that the maximum SAR in 1 g of peripheral brain tissues of the child models aged between 5 and 8 years is about two times higher than in adult models⁵². More recently in an internal IT'IS Foundation Report, Kuster *et al*.⁵³ report that spatial peak SAR of the CNS tissues of children is "significantly larger (~2x) because the RF source is closer and skin and bone layers are thinner".

In all models used, it is readily apparent that smaller heads will absorb proportionally more RF than larger heads, but size is not the only property of interest in estimating differential SAR absorption of younger and older brains. Neuro-development of the brain is an exquisitely complex process that occurs at a more rapid pace in young children than in adults. As a result, even if exposures were equal in persons of all ages, the brains of children are more vulnerable than those of adults. In 1996, Gandhi published a report modeling the greater absorption of RF into the brain of a child compared to that of an adult⁴⁷. Subsequent work refined this analysis, taking into account a range of

Table 2 - Some tissue-classified models of the head and the whole body for estimating radiofrequency absorption of humans

Author, Year	Model	Height, Weight, Sex	Derived From	Voxel Size	# of Tissues, Organs	Percentage SAR Underestimation	Cumulative Percentage SAR Underestimation for Child	Comments
Gandhi <i>et al.</i> , 1996 ⁴⁷	Utah Model	1.75 m ht, 71 kg wt; also scaled models of 5- and 10-year old children	MRI scans	1.974x1.974x2.9 mm for the model of the adult; smaller cell sizes for models of children	32	<153%	<383%	Child's heads scaled from adult's head
Dimbylow, 1998 ⁴⁵	NORMAN*	1.7 m ht, 70 kg wt to correspond to "reference man" ICRP23 ⁴⁵	MRI scan single subject	2x2x2 mm, 2.04x2.04x1.95 mm	37			
Peyman <i>et al.</i> , 2001 ⁴¹						40%	40%	Permittivity & conductivity in children is 60-80 compared to adult's 40
Gandhi and Kang, 2002 ⁴²	Utah Model	MRI-derived model of the adult and scaled models ⁴⁸ of 5- and 10-year old children	MRI scans	Different scaling factors for the head and the rest of the body		50% + >100% from 10 mm spacer + 80% for electrical parameters	~200% @ 1900 MHz; 144% @ 835 MHz	10% smaller head results in 50% underestimation of SAR
Kang and Gandhi, 2002 ⁴⁸		model of the adult	MRI scans				15%/mm of spacer	
Wang and Fujiwara, 2003 ⁴⁹	Japanese Adult Model	Scaled Models of 7- and 3-year old children adult	MRI scans of the adult					Multiple studies find children absorb more radiation than adults. See also references 42, 47, 50-52, and 54.

(continued)

Table 2 - Some tissue-classified models of the head and the whole body for estimating radiofrequency absorption of humans

Author, Year	Model	Height, Weight, Sex	Derived From	Voxel Size	# of Tissues, Organs	Percentage SAR Underestimation	Cumulative Percentage SAR Underestimation for Child	Comments
Gandhi and Kang, 2004 ³⁰	Specific-anthropomorphic phantom (SAM)	Plastic head-shaped phantom with a plastic spacer to represent the pinna	90 th percentile head size of military personnel		Filled with homogenous fluid	Underestimates SAR by a factor larger than 2	Not tested for the size of a child's head	Use of a 6-10mm thick plastic spacer makes it impossible to measure the highest SAR for the pinna
Martinez-Burdalo et al., 2004 ⁵¹	Child	Child	Scaled model from adult electrical parameters				35%	As head size decreases, the percentage of energy absorbed in the brain increases
Fernandez et al., 2005 ⁴⁴	10 years old Brazilian Model	10 year old child (1.2 m height, 35 kg, male)	102 CT scans	0.946 mm x 2.044 mm x 1.892 mm (3.10 mm ³)	10			Permittivity & conductivity of 10 year old
De Salles et al., 2006 ⁴³	10 years old Brazilian Model	10 year old child (1.2 m height, 35 kg, male)	102 CT scans	0.946 mm x 2.269 mm x 1.601 mm (3.43 mm ³)	10	60%		permittivity & conductivity of 10 year old
Wuart et al., 2008 ⁵²	Child's Head, 5 to 8 years old	Child's Head, 5 to 8 years old	MRI scans			100% (2x)		Antenna closer to skin and bone layers are thinner; penetration of radiation is twice as deep in child
Kuster et al., 2009 ⁵³	Child	Child				>100% CNS tissues		SAR of CNS of children ~twice that for adults

* NORMAN=NORMalized Man

** Scaled models of 5- and 10-year old children derived from the Utah Model using external dimensions typical of children from Geigy Scientific Tables (C. Lentner-Geigy Scientific Tables, Vol. 3, CIBA-Geigy, Basel, Switzerland, 1984).

anatomic differences between adults and children, including conductivity, density and dielectric constants. Gandhi and Kang reported that models with a head that was only about 10% smaller in size could have more than 50% greater SAR with two different antenna lengths, with proportionally deeper penetration of SAR⁴². This work also showed that incorporating a plastic ear model or pinna with a 10 mm spacer gave artificially lowered SAR-values, which are up to two or more times smaller than for realistic anatomic models, as a result of the larger distance to the absorptive tissues. The higher dielectric constant and conductivities likely for younger subjects will result in still higher SAR (up to 80% more) for children.

The peak 1-g body tissue SAR for the smaller head sizes calculated using the widely accepted Finite-Difference Time-Domain (FDTD) computational EMFs method can be up to 56% higher at 1900 MHz and up to 20% higher at 835 MHz compared to the larger models. For brain tissue, the proportionality was even higher where the peak 1-g SAR for the smaller model was up to 220% higher at 1900 MHz and up to 144% higher at 835 MHz of the SARs of the larger models. Similar to the results reported in the earlier 1996 paper for head models of adult and children, these latter results confirmed that there is a deeper penetration of absorbed energy for the smaller head models e.g. the children compared to that for the larger head models representative of adults.

In 2004, a IEEE Standards Coordinating Committee introduced a standard anthropomorphic mannequin (SAM) Model, with a 6-10 mm thick plastic spacer instead of “pinna” for determination of SAR of mobile phones for compliance testing against IEEE and ICNIRP Safety Guidelines (IEEE, 2003). That same year, Gandhi and Kang demonstrated that the “SAM model” with plastic spacer used for compliance testing (preferred by industry) gives SARs that grossly underestimate exposures⁵⁰. In two different published studies, the use of plastic spacers results in an underestimation of the SAR by up to 15% for every additional millimeter of thickness of such spacers^{48, 50}. Thus, the SAR obtained for SAM is up to two or more times smaller than for the anatomic models of the adult head. When other developmental variables are taken into account, this underestimation is even higher for exposure to the smaller heads of the children.

A modified SAM model with a lossy pinna similar to living tissue for which 1- and 10-g SARs are relatively close to those for anatomic models, could remedy this systematic underestimation of exposure of the children by using a fluid of higher conductivity than that currently used for compliance testing⁴². Without this correction, current IEEE limits⁵⁶ effectively allow RF that may be 8-16 times higher⁵⁰ than those permitted by previous IEEE guidelines^{56, 57}. This is also due to increasing the SAR limit in the pinna from 1.6 W/kg for any 1-g of tissue to 4.0 W/kg for a larger 10-g of tissue that was originally suggested to apply only to the extremity tissues for the arms and the legs^{57, 58}.

In fact, multiple studies have reported that the brains of young children absorb more radiation compared to those of adults^{43, 47-49, 51-53}. As the brains of children lack neural integration and are not fully myelinated until the twenties, the impact of such greater absorption may be considerable. In addition, this differential absorption of the brain may well render children more vulnerable to the development of both benign and malignant brain tumors, a point indicated in the review of this subject by the National Research Council⁵⁹. Studies by Wiart for French Telecom published last year⁵² and other work by Kuster⁶⁰ confirmed that a given signal is absorbed about twice as deeply into the bone marrow of the head and cortex of a child in contrast with that of an adult, even though systemic absorption may not differ substantially. A series of papers by De Salles also offers important modeling information regarding the increased vulnerability of a child's

Table 3 - Summary of the results confirming that children absorb more radiated electromagnetic energy of the cell phones resulting in higher specific absorption rate (SAR) as compared to adults

Author, Year	Highlights of results
Gandhi <i>et al.</i> , 1996 ⁴⁷	Deeper penetration of absorbed energy for models of 10- and 5-year old children; peak 1-g SAR for children up to 53% higher than adults.
Gandhi and Kang, 2002 ⁴²	Deeper penetration of absorbed energy for smaller heads typical of women and children; peak 1-g SAR for smaller heads up to 56% higher than for larger heads.
Wang and Fujiwara, 2003 ⁴⁹	Compared to peak local SAR in the adult head, we found “a considerable increase in the children’s heads” when we fixed the output power of radiation.
Martinez-Burdalo <i>et al.</i> , 2004 ⁵¹	As head size decreases, the percentage of energy absorbed in the brain increases; so higher SAR in children’s brains can be expected.
DeSalles <i>et al.</i> , 2006 ⁴³	The 1-g SAR for children is about 60% higher than for the adults.
Wiat <i>et al.</i> , 2008 ⁵²	1-g SAR of brain tissues of children is about two times higher than adults.
Kuster <i>et al.</i> , 2009 ⁵³	Spatial peak SAR of the CNS of children is “significantly larger (~2x) because the RF source is closer and skin and bone layers are thinner”; “bone marrow exposure strongly varies with age and is significantly larger for children(~10x)”

head⁴³. Based on CT images of a 10 year old boy, these models confirm the greater absorption of the child and add further support regarding the need to eliminate the plastic spacer at the ear or pinna in estimating exposures to children. A summary of the results confirming that children (and smaller heads typical of women) absorb more radiated energy of cell phones resulting in higher SAR is given in Table 3.

Implications of modeling limitations for current standards

Both the IEEE and ICNIRP guidelines are based only on short-term EMFs exposure and long-term EMFs exposures are not considered. Please refer to page 496²:

“Induction of cancer from long-term EMFs exposure was not considered to be established, and so these guidelines are based on short-term, immediate health effects such as stimulation of peripheral nerves and muscles, shocks and burns caused by touching conducting objects, and elevated tissue temperatures resulting from absorption of energy during exposure to EMFs. In the case of potential long-term effects of exposure, such as an increased risk of cancer, ICNIRP concluded that available data are insufficient to provide a basis for setting exposure restrictions, although epidemiological research has provided suggestive, but unconvincing, evidence of an association between possible carcinogenic effects and exposure at levels of 50/60 Hz magnetic flux densities substantially lower than those recommended in these guidelines”.

The increase in the SAR in the whole head, between the adult and the child, is expected due to the reduced dimensions in the child head, as well as the higher values of the permittivity and of the electrical conductivity of the child brain tissues. Also, children's skulls are thinner than those of adults, and therefore less resistant to radiation.

Another concern is that only thermal effects of RF are considered when estimating the SAR. However, since most mobile communication systems now are pulse-like in nature, modulated at low frequencies, such as in 2G and 3G (e.g., the GSM, UMTS, CDMA, TDMA systems), they are able to induce pulses of currents in the brain tissues and this can result in some low level non-thermal effects, e.g., BBB alterations, single and double strand DNA breaks, chromosomal aberrations, etc., at RF energy levels substantially below the thermal threshold. Several papers and reports have already shown adverse health effects at exposure levels well below the thermal limits^{4, 6, 12, 13, 61}. Further epidemiological studies have shown a many-fold increase in risk for malignant brain tumors, with a larger than 10 years latency period for long-term mobile phone and cordless phone users²³. As a substantial percentage of the population now uses mobile phones for a long time during each day and for several years, operating the antenna very close to their head, then this exposure can not be classified as short term and effectively may represent a serious risk for their health.

Future research needs

There is a need for exposure assessment of juveniles, children, pregnant women and fetuses from personal wireless devices (the wireless devices considered here are the cell phones, wireless PCs and text messaging devices), waist and pocket-mounted devices since mostly adult male models have been considered to date. These studies will focus on development and exposure quantification of anatomic models of several heights and weights of men, women and children of various ages as well as pregnant women and fetuses.

There is an urgent need for characterization of microwave radiated fields from the currently used multi-frequency, multi-element base station antennas; identification of exposed individuals and their locations e.g. school children, building maintenance personnel, etc. There is a paucity of data in regard to radiated electromagnetic fields and the daily variation in time for the newer 4-6 element or more collocated base station antennas and the exposures these antennas entail for the school children and the civilian population living close to such antennas.

An updated survey is needed of the civilian exposure to microwave electromagnetic fields strengths in the U.S. due to the rapidly expanding wireless infrastructure in the last 10-15 years. The last survey involving selected 15 metropolitan areas and mostly focused on VHF and UHF TV stations was reported back in 1980.⁶² This data is totally out of date at the present time.

An expert (non-industry dominated) evaluation of the current IEEE and ICNIRP RF/microwave safety standards in the light of more recent biological experiments is also critical. All of the current safety standards are based on extrapolation from acute short-term exposures and do not account for the modulated signals used in cell phones and other personal wireless devices.

Discussion

The summary of modeling research presented here indicates three major shortcomings of the current IEEE and ICNIRP approaches: 1) the assumption that only thermal effects can occur is not valid. There is growing evidence from *in vitro* and *in vivo* studies indicating that RF exposures at levels not known to induce thermal effects commonly encountered today have a range of biological effects, affecting production of free radicals, permeability of the BBB, expression of in heat shock proteins, and direct damage to DNA, as indicated by the comet assay and a variety of *in vitro* measures of genotoxicity; 2) properties of the head models currently used fail to take into account differences in dielectric constant and conductivity and improper modeling of the pediatric brain, as well as developmental differences such as myelination between the young and older brains; 3) the assumptions as to typical use patterns used in setting these standards, with a six minute average call time, do not reflect current patterns, according to reports from the cell phone industry, where monthly use can easily top 2000 minutes with many calls well in excess of 6 minutes.

Excepting the occasional advertisement, there is no publicly accessible, independently confirmable, information on the details of rapidly expanding markets and uses of cell phones, which makes the development of standards especially challenging. Cell phones are used by many people for much of their waking hours, having replaced traditional phones, alarm clocks, newspapers, radios, global positioning devices, video-cameras and televisions.

Regarding young children, we do not know the typical practice of the young at this point, because those behaviors are changing rapidly. However, we do know school districts are being urged to adopt cell phones for all middle school students as learning tools. This may well be an excellent idea for the purposes of learning, providing that phones are not used and held directly to the developing brain. Whether the use of cell phones as phones proves a potential hazard to the long-term health of the pediatric brain is an issue that merits serious attention. Radiation compliance standards for operation of cell phones are based exclusively on adult male models of the head. Emerging research indicates that long-term heavy users of cell phones face a doubled risk of several forms of brain tumors and risks may well be greater for those who begin regularly using phones before age 20. In light of these facts, the European Environment Agency and several other national advisory groups have adopted a precautionary approach to keep cell phone exposure to a minimum through use of ear-pieces and speaker phones, wired headsets, and to urge that children generally not use cell phones.

To enhance the ability to protect public health and foster better design of this widely used technology, we advise a three-pronged approach: major studies should be undertaken to construct and validate gender and age-appropriate head models further. More research is needed to identify and evaluate the mechanisms through which non- or thermal effects of RF arise and to determine more definitively the extent of health risks from long term use of cell phones, particularly by children. While that work is proceeding, precautionary policies should be advanced to limit potential harm to the developing brain. This should include consideration of directional antennas designed to send signals away from the head since the tissues absorb almost all of the energy radiated in the direction of the head anyway. Responsible public health authorities around the world should disseminate warnings for cell phone users such as those advocated recently in France, Finland and Israel. This involves advising children and their parents

along with the young to make only short and essential calls, to use text messaging when possible, to use always hands free kits and wired headsets, and maintain the antenna far away from their body during the calls. Given the prevalence of this revolutionary technology, some evidence of its chronic toxicity, and the lack of solid information regarding its potential hazards to humans, it is important that major independent, multi-disciplinary research programs be carried out to study and monitor the long-term impact of RF exposures.

Acknowledgement

Support for this work was provided in part by grants from the National Institute of Environmental Health Science, the Heinz Endowments, the Jennie Zoline Foundation, the Environmental Health Trust, and center grants from the National Cancer Institute to the University of Pittsburgh Cancer Institute. The authors declare that they have no competing interests. Constructive comments have been provided by Lloyd Morgan and Allan Frey.

References

1. IEEE. ANSI/IEEE C95.1-1992-safety levels with respect to human exposure to radio frequency electromagnetic fields, 3 kHz to 300 GHz. 1992.
2. ICNIRP. International Commission on Non-Ionizing Radiation Protection (ICNIRP) - Guidelines for limiting exposure to time-varying electric, magnetic, and electromagnetic fields (up to 300 GHz). *Health Phys* 1997; 74: 494-522.
3. The BioInitiative Working Group. BioInitiative Report: a rationale for a biologically-based public exposure standard for electromagnetic fields. www.bioinitiative.org.
4. Ruediger HW. Genotoxic effects of radiofrequency electromagnetic fields. *Pathophysiology* 2009; 16(2-3): 89-102.
5. IEGMP. Independent Expert Group on Mobile Phones, Report of the group (The Stewart Report): mobile phones and health. <http://www.iegmp.org.uk/report/index.htm>.
6. Salford LG, Brun AE, Stuesson K, *et al.* Permeability of the blood-brain barrier induced by 915 MHz electromagnetic radiation, continuous wave and modulated at 8, 16, 50, and 200 Hz. *Microsc Res Tech* 1994; 27(6): 535-42.
7. ATSDR. Agency for Toxic Substances and Disease Registry. Summary of health effects of ionizing radiation, toxicological profile for ionizing radiation. <http://www.atsdr.cdc.gov/toxprofiles/tp149.html>.
8. Nittby H, Brun AE, Eberhardt J, *et al.* Increased blood-brain barrier permeability in mammalian brain 7 days after exposure to the radiation from a GSM-900 mobile phone. *Pathophysiology* 2009; 16(2-3): 103-12.
9. Salford LG, Brun AE, Eberhardt JL, *et al.* Nerve cell damage in mammalian brain after exposure to microwaves from GSM mobile phones. *Environ Health Perspect* 2003; 111(7): 881-3; discussion A408.
10. Moseley H. Non-Ionizing Radiation - Biological Effects of Microwaves and RF. *Medical Physics Handbooks* 18, 1988: 38-61.
11. Bernhart JH. Non-Ionizing radiation safety: radiofrequency radiation, electric and magnetic fields physics on medicine and biology. *Phys Med Biol* 1992; 37: 807-44.
12. Lai H, Singh NP. Single- and double-strand DNA breaks in rat brain cells after acute exposure to radiofrequency electromagnetic radiation. *Int J Radiat Biol* 1996; 69(4): 513-21.
13. REFLEX. Final report. Risk evaluation of potential environmental hazards from low frequency electromagnetic field exposure using sensitive in vitro methods. http://www.itis.ethz.ch/downloads/REFLEX_Final%20Report_171104.pdf
14. Huss A, Egger M, Hug K, *et al.* Source of funding and results of studies of health effects of mobile phone use: systematic review of experimental studies. *Environ Health Perspect* 2007; 115(1): 1-4.

15. Kundi M. The controversy about a possible relationship between mobile phone use and cancer. *Environ Health Perspect* 2009; 117(3): 316-24.
16. Hardell L, Carlberg M, Soderqvist F, *et al.* Long-term use of cellular phones and brain tumours: increased risk associated with use for > or =10 years. *Occup Environ Med* 2007; 64(9): 626-32.
17. Hardell L, Hallquist A, Mild KH, *et al.* Cellular and cordless telephones and the risk for brain tumours. *Eur J Cancer Prev* 2002; 11(4): 377-86.
18. Christensen HC, Schuz J, Kosteljanetz M, *et al.* Cellular telephone use and risk of acoustic neuroma. *Am J Epidemiol* 2004; 159(3): 277-83.
19. Lonn S, Ahlbom A, Hall P, *et al.* Mobile phone use and the risk of acoustic neuroma. *Epidemiology* 2004; 15(6): 653-9.
20. Schoemaker MJ, Swerdlow AJ, Ahlbom A, *et al.* Mobile phone use and risk of acoustic neuroma: results of the Interphone case-control study in five North European countries. *Br J Cancer* 2005; 93(7): 842-8.
21. Schuz J, Jacobsen R, Olsen JH, *et al.* Cellular telephone use and cancer risk: update of a nationwide Danish cohort. *J Natl Cancer Inst* 2006; 98(23): 1707-13.
22. Hardell L, Carlberg M, Hansson Mild K. Pooled analysis of two case-control studies on use of cellular and cordless telephones and the risk for malignant brain tumours diagnosed in 1997-2003. *Int Arch Occup Environ Health* 2006b; 79(8): 630-9.
23. Hardell L, Carlberg M, Soderqvist F, *et al.* Meta-analysis of long-term mobile phone use and the association with brain tumours. *Int J Oncol* 2008; 32(5): 1097-103.
24. Christensen HC, Schuz J, Kosteljanetz M, *et al.* Cellular telephones and risk for brain tumors: a population-based, incident case-control study. *Neurology* 2005; 64(7): 1189-95.
25. Lonn S, Ahlbom A, Hall P, *et al.* Long-term mobile phone use and brain tumor risk. *Am J Epidemiol* 2005; 161(6): 526-35.
26. Hepworth SJ, Schoemaker MJ, Muir KR, *et al.* Mobile phone use and risk of glioma in adults: case-control study. *BMJ* 2006; 332(7546): 883-7.
27. Schuz J, Bohler E, Berg G, *et al.* Cellular phones, cordless phones, and the risks of glioma and meningioma (Interphone Study Group, Germany). *Am J Epidemiol* 2006; 163(6): 512-20.
28. Lahkola A, Salminen T, Raitanen J, *et al.* Meningioma and mobile phone use—a collaborative case-control study in five North European countries. *Int J Epidemiol* 2008; 37(6): 1304-13.
29. Hardell L, Carlberg M, Mild KH. Case-control study of the association between the use of cellular and cordless telephones and malignant brain tumors diagnosed during 2000-2003. *Environ Res* 2006a; 100(2): 232-41.
30. Hardell L, Carlberg M. Mobile phones, cordless phones and the risk for brain tumours. *Int J Oncol* 2009; 35(1): 5-17.
31. Takebayashi T, Akiba S, Kikuchi Y, *et al.* Mobile phone use and acoustic neuroma risk in Japan. *Occup Environ Med* 2006; 63(12): 802-7.
32. Schlehofer B, Schlaefer K, Blettner M, *et al.* Environmental risk factors for sporadic acoustic neuroma (Interphone Study Group, Germany). *Eur J Cancer* 2007; 43(11): 1741-7.
33. Klæboe L, Blaasaas KG, Tynes T. Use of mobile phones in Norway and risk of intracranial tumours. *Eur J Cancer Prev* 2007; 16(2): 158-64.
34. The INTERPHONE Study Group. Brain tumour risk in relation to mobile telephone use: results of the INTERPHONE international case-control study. *Int J Epidemiol* 2010; 39(3): 675-94.
35. Lahkola A, Auvinen A, Raitanen J, *et al.* Mobile phone use and risk of glioma in 5 North European countries. *Int J Cancer* 2007; 120(8): 1769-75.
36. Myung SK, Ju W, McDonnell DD, *et al.* Mobile phone use and risk of tumors: a meta-analysis. *J Clin Oncol* 2009; 27(33): 5565-72.
37. Han YY, Kano H, Davis DL, *et al.* Cell phone use and acoustic neuroma: the need for standardized questionnaires and access to industry data. *Surg Neurol* 2009; 72(3): 216-22.
38. Huber R, Treyer V, Borbely AA, *et al.* Electromagnetic fields, such as those from mobile phones, alter regional cerebral blood flow and sleep and waking EEG. *J Sleep Res* 2002; 11(4): 289-95.
39. Krause CM, Sillanmaki L, Koivisto M, *et al.* Effects of electromagnetic fields emitted by cellular phones on the electroencephalogram during a visual working memory task. *Int J Radiat Biol* 2000; 76(12): 1659-67.
40. Benes FM, Turtle M, Khan Y, *et al.* Myelination of a key relay zone in the hippocampal formation

- occurs in the human brain during childhood, adolescence, and adulthood. *Arch Gen Psychiatry* 1994; 51(6): 477-84.
41. Peyman A, Rezazadeh AA, Gabriel C. Changes in the dielectric properties of rat tissue as a function of age at microwave frequencies. *Phys Med Biol* 2001; 46(6): 1617-29.
 42. Gandhi OP, Kang G. Some present problems and a proposed experimental phantom for SAR compliance testing of cellular telephones at 835 and 1900 MHz. *Phys Med Biol* 2002; 47(9): 1501-18.
 43. De Salles AA, Bulla G, Rodriguez CE. Electromagnetic absorption in the head of adults and children due to mobile phone operation close to the head. *Electromagn Biol Med* 2006; 25(4): 349-60.
 44. Fernández CR, Bulla G, Pedra AC, *et al.* Comparison of electromagnetic absorption characteristics in the head of adult and children for 1800 MHz mobile phones. Paper presented at: International Microwave and Optoelectronics Conference (IMOC 2005); Brasilia, Brazil, 2005.
 45. Dimbylow PJ. Induced current densities from low-frequency magnetic fields in a 2 mm resolution, anatomically realistic model of the body. *Phys Med Biol* 1998; 43(2): 221-30.
 46. ICRP. International Commission on Radiological Protection. Report of the task group on reference man. ICRP Publication 23. Oxford: Pergamon Press, 1992.
 47. Gandhi OP, Lazzi G, Furse CM. Electromagnetic absorption in the human head and neck for mobile telephones at 835 and 1900 MHz. *IEEE Trans Microw Theory Tech* 1996; 44(10): 1884-97.
 48. Kang G, Gandhi OP. SARs for pocket-mounted mobile telephones at 835 and 1900 MHz. *Phys Med Biol* 2002; 47(23): 4301-13.
 49. Wang J, Fujiwara O. Comparison and evaluation of electromagnetic absorption characteristics in realistic human head models of adult and children for 900-MHz mobile telephones. *IEEE Trans Microw Theory Tech* 2003; 51(3): 966-71.
 50. Gandhi OP, Kang H. Inaccuracies of a plastic “Pinna” SAM for SAR testing of cellular telephones against IEEE and ICNIRP safety guidelines. *IEEE Trans Microw Theory Tech* 2004; 52(8): 2004-12.
 51. Martínez-Burdalo M, Martín A, Anguiano M, *et al.* Comparison of FDTD-calculated specific absorption rate in adults and children when using a mobile phone at 900 and 1800 MHz. *Phys Med Biol* 2004; 49(2): 345-54.
 52. Wiart J, Hadjem A, Wong MF, *et al.* Analysis of RF exposure in the head tissues of children and adults. *Phys Med Biol* 2008; 53(13): 3681-95.
 53. Kuster N, Gosselin MC, Kuhn S, *et al.* Past, current, and future research on the exposure of children. ITIS Foundation Internal Report 2009.
 54. Schonborn F, Burkhardt M, Kuster N. Differences in energy absorption between heads of adults and children in the near field of sources. *Health Phys* 1998; 74(2): 160-8.
 55. Anderson V. Comparisons of peak SAR levels in concentric sphere head models of children and adults for irradiation by a dipole at 900 MHz. *Phys Med Biol* 2003; 48(20): 3263-75.
 56. IEEE. IEEE Std 1528™-IEEE recommended practice for determining the peak spatial-average Specific Absorption Rate (SAR) in the human head from wireless communications devices: measurement techniques. 2003.
 57. IEEE. IEEE Std C95.3™-IEEE recommended practice for the measurement of potentially hazardous electromagnetic fields - RF and Microwave. 1991.
 58. IEEE. IEEE Std C95.1™-IEEE standard for safety levels with respect to human exposure to radio frequency electromagnetic fields, 3 kHz to 300 GHz. 1999.
 59. NRC. National Research Council- Identification of research needs relating to potential biological or adverse health effects of wireless communication, 2008.
 60. Kuster N, Schuderer J, Christ A, *et al.* Guidance for exposure design of human studies addressing health risk evaluations of mobile phones. *Bioelectromagnetics* 2004; 25(7): 524-9.
 61. Lai H. Biological effects of radiofrequency electromagnetic field. In: Bowlin GL, Wnek G, eds. *Encyclopedia of Biomaterials and Biomedical Engineering*. DOI: 10.1081/E-EBBE-120041846, 2005.
 62. Tell RA, Mantiply ED. Population exposure to VHF and UHF broadcast radiation in the United States. *Proceedings of the IEEE* 1980; 68: 6-12.

Investigation on blood-brain barrier permeability and collagen synthesis under radiofrequency radiation exposure and SAR simulations of adult and child head

Nesrin Seyhan, Goknur Guler, Ayse Canseven, Bahriye Sirav, Elcin Ozgur,
Mehmet Z. Tuysuz

Gazi University, Faculty of Medicine, Department of Biophysics & Gazi Non-Ionizing Radiation Protection Center – GNRP, Ankara, Turkey

Abstract

The effects of Radiofrequency Radiation (RFR) in the frequencies of mobile phones (835, 900, 1800 MHz) on the permeability of blood-brain barrier and hydroxyproline formation along with the modeling studies performed at the Gazi Biophysics Laboratory are reviewed in this paper. The close proximity of a mobile phone to a user's head leads to absorption of part of the mobile phone emitted energy by the head and the brain of the phone user. Permeability of the blood-brain barrier (BBB) of female and male rat brain tissues was examined under 900 MHz and 1800 MHz continuous-wave radiofrequency radiation (CW-RFR) exposure. Increase in BBB permeability was found to be statistically significant in all male rats exposed, whereas no significant difference was observed in female rats. Investigations of the mobile phone radiation effects on biomolecules were also carried out with guinea pigs. Alterations in protein synthesis were quantified by measuring hydroxyproline level in exposed and non-exposed liver tissues by using three different biochemical methods. There was no significant difference on hepatic hydroxyproline levels of RFR exposed guinea pig. In a simulation study, the effects of 835 MHz and 900 MHz RFR exposures on human head while using cellular phone (CP) were investigated. The effects of CP usage on specific absorption rate (SAR) were calculated by SEMCAD X software which uses FDTD method in details. Some parameters as the different head dimensions and dielectric properties of the head (adult and child), positions of the mobile phone (cheek and tilt), and rectangular metal frame spectacles as a widely used metallic accessory were considered. With this aim, dose values in the tissue for 10 g peak spatial-average SAR value were calculated. At both of the frequencies of 835 MHz and 900 MHz, higher SAR values were obtained in the cheek positions than the tilt positions for conditions of with or without metal frame spectacles.

Key words: Radio Frequency Radiation (RFR), Blood-Brain Barrier (BBB), Collagen Synthesis (CS), Specific Absorption Rate (SAR), FDTD

Introduction

During recent years, mobile communication systems have experienced wide and rapidly growing use all over the world. Many studies have investigated whether mobile phone use and radiofrequency (RF) fields in general could have biological effects. The close proximity of the antenna of a mobile phone to the human body and especially the head has raised concerns about the biological interactions of electromagnetic radiation (EMR). Conflicting results were reported on whether low levels of radiofrequency fields increase the permeability of the barrier that keeps harmful substances from entering the brain (blood-brain barrier). In 2008, there was a review on the blood-brain barrier (BBB) which includes a complex picture indicating that some studies showed effects on the blood-brain barrier, whereas others did not. Possible mechanisms for the interactions between electromagnetic fields and living organisms were also discussed in that paper¹. One of the important aims of the present study was to investigate the effects of 900 MHz and 1800 MHz continuous wave (CW) RFR on the permeability of BBB of young adult male and female rats.

Effects of static and ELF electric and magnetic fields on collagen have been studied at the Gazi Biophysics Department and hydroxyproline levels of skin, liver, kidney and lung tissues were found to change after exposure to these fields²⁻⁸. There is very limited number of studies on the effect of RFR at mobile phone range on the tissue level of collagen⁹⁻¹⁰. In this paper, we report our investigation on the effects of mobile phone radiation on collagen synthesis. Collagen was examined by using three different hydroxyproline detection methods such that we could repeat and cross-check our biochemical work and results by these three methods¹¹.

Dosimetry is an important issue on monitoring the biological effects of RFR exposure¹². In a Specific Absorption Rate (SAR) simulation study, the aim was to investigate how SAR changes with various anatomical human head models^{13, 14}. Generic Mobile Phone model which is accepted by the Mobile Manufacturers Forum (MMF) were used in this study¹⁵. Frequencies were selected as 835 MHz and 900 MHz to compare the dose rates of cellular phones (CP) which have been used in the United States and Europe, respectively. Dielectric properties and sizes of phantoms studied were according to the standards of IEEE 1528-2003 and IEC 62209-1 for adult SAM phantom. Children are more affected by RFR with respect to adults¹⁶⁻¹⁸ because of the dimensions and the dielectric properties of their head. Furthermore, SAR simulations of children head models were done for the same frequencies by applying the data from the studies of Peyman and Gabriel's according to the standards of IEEE 1528-2003 and IEC 62209-1 2005^{19,20}.

Materials and methods

Blood brain barrier study

Twenty five male (268.13 ± 41.92 g) and twenty seven female (216.85 ± 24.72 g) young adult Wistar albino rats were used in the study. Four exposure and two control groups were used in the experiment: Group I (n=8)- control males, Group II (n=9)-control females, Group III (n=8)- 900 MHz exposed males, Group IV (n=9)- 900 MHz exposed females, Group V (n=9)- 1800 MHz exposed males, Group VI (n=9)-1800 MHz exposed females. Animals in the control groups were sham-exposed. The animals were

anesthetized with ketamine (45 mg/kg) and xylazine (5 mg/kg) by intramuscular injection prior to the experiments²¹.

Exposed groups were kept at 10 cm away from a horn antenna to satisfy the near field condition. Control (sham) groups were kept in the same setting without any RFR exposure. Synthesized signal generator was used for propagating the RF signal. Field strengths were monitored with a Narda EMR 300 and its appropriate probe (8.3) during the exposures. Background E-field level to which controls were exposed, was measured to be 0.265 ± 0.02 V/m. E-field levels at 900 MHz and 1800 MHz were 13.51 ± 0.41 V/m and 12.62 ± 0.22 V/m, respectively^{22, 23}. RFR or sham exposure duration was 20 minutes for all animals. The experiments were performed with the anesthetized rats in a quiet laboratory with little noise to limit stress. ICNIRP general public E-field limits for these frequencies are 41.25 V/m and 58.34 V/m²⁴. Since the E-field levels in this study are well below currently accepted limits, the exposure level used in this study can be considered non-thermal.

We investigated permeability of BBB using Evans Blue (EB) dye as a tracer which is known to bind to serum albumin after intravenous injection. Quantative method was used for measuring the amount of dye in the brain^{25, 26}. EB dye (2% in saline, 4 ml/kg) was injected into the tail vein of a rat and was allowed to circulate for 20 min. An animal was then exposed to RFR or sham fields for 20 min period. At the end of each exposure, its chest was opened under anesthesia. Brains were perfused with saline through the left ventricle for approximately 15 min until fluid exiting from the right atrium became colorless. Brain was then removed and dissected into four regions: left and right cerebrum, left and right cerebellum. Each brain region was weighted for quantative estimation of EB dye - albumin extravasations. The samples were then homogenized in 2.5 ml phosphate buffered saline-PBS and mixed with a vortex after the addition of 2.5 ml of 60% trichloroacetic acid to precipitate the protein molecules, then centrifuged for 30 min in 3000 rpm (at 1000xg). The supernatant was measured at 620 nm for absorbance of EB dye using a spectrophotometer. The concentration of EB per gram of brain was determined from the absorption measurements using a standard curve. E-field levels and EB contents are presented as the mean \pm SD for each group. Mann-Whitney U-Test was used to assess significance and $p < 0.01$ was considered statistically significant.

Radio frequency radiation effect on collagen

In this investigation, 30 three-month-old male Guinea pigs (250-300 g) were used. They were divided into three groups: sham exposed, 10 minutes mobile phone-exposed, and 20 minutes mobile phone-exposed. Animals that had their own private cage were placed inside the cage just at the beginning of the experiment in order to reduce stress. Cages, made of transparent plastic with the dimensions of 8 cm x 10 cm x 18 cm, have efficient holes for ventilation. RF source was a Nokia 3210 mobile phone with 0.81 W/kg digital SAR value was positioned on the cage where the antenna of the mobile phone is maximum 5 cm above the head of the guinea pig. While mobile phone is at off mode for the sham exposure condition, it was in talking position during the exposure conditions. Measurements were taken instantaneously during the experiment by NARDA EMR 300 and a type 8.3 probe and the data saved to the computer connected to device via fiber optic cable. Guinea pigs were exposed to RFR averaged as 11.2 ± 0.5 V/m for 10 minutes²⁷ and 20 minutes a day during 7 days and analyzed for the effects on liver tissue hydroxyproline level.

After the last day of mobile phone exposure, liver tissues were removed from animals after decapitation. They were immediately frozen in liquid nitrogen and stored at -80°C until analysis. Changes of hydroxyproline level were analyzed biochemically by three different hydroxyproline determination methods: “H. Stegemann-K. Stalder”²⁸⁻³¹, “I.S. Jamall-V.N. Finell”³² and “ISO 3496”³³.

Principle of the first method, named “H. Stegemann-K. Stalder”, is to get the hydroxyproline of the hydrolysis of the tissue sample after homogenization and measuring the optical density of the color formed by adding p-dimethylaminobenzaldehyde, perchloric acid and propan-2-ol at pH 8 and at λ (wavelength) = 560 nm.

The “I.S. Jamall-V.N. Finell” method is based on oxidation of hydroxyproline after the hydrolysis of the tissue sample by kloramin-T and formation of chromophore complexes via the reaction with Ehrlich reactive including p-dimethylaminobenzaldehyde and perchloric acid. Optical density of the solution at pH 6 was measured with respect to water at $\lambda = 560$ nm.

The third one known as “ISO 3496” is to get the hydroxyproline of the hydrolysis of the sample after homogenization and measuring the optical density of the color formed by adding sulphuric acid at pH 6.6 at $\lambda = 558$ nm.

For each method, hydroxyproline contents of the tissue samples were determined using standard curves for samples containing known concentrations of hydroxyproline (Sigma H-1637). Two samples were taken from each homogenized tissue, and the concentrations measured by spectrometry were averaged. For each group, hydroxyproline contents of tissues from groups exposed to RF radiation and their controls were compared with ANOVA, Welch ANOVA tests.

SAR simulations of adult and child head

SAR levels resulted from CP exposures were determined by the SEMCAD-X software. SAM phantom and generic CP model were used to assess peak SAR values averaged over 10 g of tissue. The effects of some parameters such as metallic accessories like spectacles, different positioning of CP, different head dimensions and different dielectric properties on SAR were determined at 835 MHz and 900 MHz frequencies^{13, 14}. Selected general cell phone model which is approved by the Mobile Manufacturers Forum has three parts: a monopole antenna, a plastic chassis and a printed circuit board made by perfect electric conducting material inside this plastic chassis. SAR values were obtained by normalizing antenna input power to 1 Watt. It was assumed that phone model sizes are 102 mm x 42 mm x 21 mm (height x width x thickness) and it consists of a hard plastic chassis. Antenna was mounted on the top part of the chassis at the center. Antenna height was modeled as 20% shorter than quarter wave ($\lambda/4$) height to obtain reasonable input impedance near different head models^{15,34}.

Adult head phantom's circumference was scaled with 0.9 factors in order to obtain a child phantom for a 7-year-old child³⁵. Dielectric properties of SAM phantom for adult and child are given in Table 1^{19, 20, 36, 37}.

In the study, a spectacles frame was modeled presuming that it was 37 mm width and 63 mm height and made of Perfect Electric Conducting metal. The length of spectacles' arm is 140 mm and Perspex lens was selected.

Table 1 - Dielectric properties of adult and child SAM phantoms

Frequency	Adult*		Child**	
	ϵ_r	σ (S/m)	ϵ_r 109,85 %	σ (S/m) 116 %
835 MHz	41,5	0,90	45,59	1,0440
900 MHz	41,5	0,97	45,59	1,1252

* Dielectric properties of adult SAM phantom taken from IEEE 1528 and IEC 62209-1

** Dielectric properties of child SAM phantom which was extrapolated from IEEE 1528 and IEC 62209-1 by using Gabriel and Peyman studies¹⁹⁻²⁰

Results

Blood brain barrier study

In the study, we investigated the effects of exposure to continuous-wave (CW) RFR at 900 MHz and 1800 MHz for 20 min on the permeability of BBB of rats. Male and female rats (Groups III and IV, respectively) were exposed to 900 MHz at an electric (E) field of 13.51 ± 0.41 V/m and rats in 1800 MHz groups (Groups V and VI) were exposed to an E field of 12.62 ± 0.22 V/m. In all exposed and sham-exposed groups, albumin extravasations occurred largely from leptomeningeal blood vessels which, together with those in the choroid plexus and circumventricular organs, have no recognizable blood-brain barrier.

In the male groups Evans Blue dye content in the whole brain was found to be 0.072 ± 0.01 mg % in the controls, 0.1325 ± 0.02 mg % in 900-MHz exposed group and 0.1123 ± 0.02 mg % in the 1800-MHz exposed group (fig. 1). Difference between the exposed groups and controls was found to be significant ($p < 0.01$). No statistically significant difference was found between the two RFR-exposed groups.

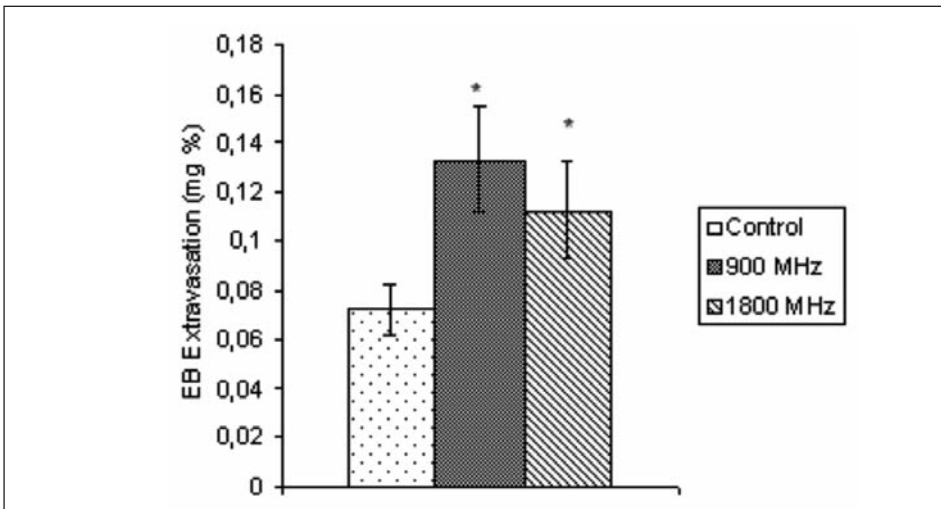

Fig. 1. Brain EB content of male rats. Data is shown as mean \pm standard deviation of the mean (SD)

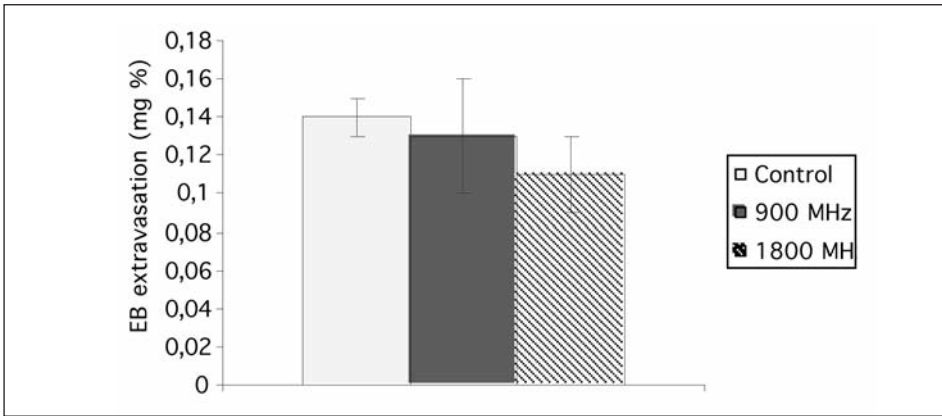

Fig. 2. Brain EB content of female rats

In the female groups, dye content in the whole brain was found to be 0.14 ± 0.01 mg % in controls, 0.13 ± 0.03 mg % in the 900-MHz exposed and 0.11 ± 0.02 mg % in the 1800-MHz exposed groups (fig. 2). No statistically significant difference was found between two RFR-exposed groups ($p > 0.01$). There was also no statistically significant difference between the exposed females and the controls ($p > 0.01$).

Our results showed that a 20-min exposure to 900-MHz and 1800-MHz RFR induced an increase in permeability of BBB of young adult male rats. However, similar exposure to RFR did not induce an effect on the permeability of BBB in young adult female rats.

Radiofrequency radiation effect on collagen

Results are shown in Table 2 and fig. 3. The outcome of the biochemical analysis indicated that hydroxyproline level increased with respect to control but this increase was not statistically significant for all three methods of analysis ($p > 0.05$). The results showed no significant effect of RFR exposure on liver hydroxyproline in the guinea pig. However, difference in hydroxyproline determination accuracy of ISO 3496 method with respect to the other two methods was found to be statistically significant ($p < 0.05$) (Table 2 - fig. 4).

Table 2 - Comparison of liver tissue hydroxyproline levels ($\mu\text{g/g}$ tissue) in groups exposed to RFR for 10 and 20 minutes with controls measured by three different methods. The values in the table represent the least squares means \pm standard deviation (mean \pm Sd)

	H. Stegemann-K. Stalder	I.S. Jamall-V.N. Finell	ISO 3496
Sham exposed group	0.2716 ± 0.0289	0.2897 ± 0.0622	0.3054 ± 0.0125
10 min. Exposure group	0.2773 ± 0.0251	0.2907 ± 0.0185	0.3058 ± 0.0186
20 min. Exposure group	0.2794 ± 0.0282	0.2907 ± 0.0240	0.3075 ± 0.0124

SAR simulations of adult and child head

Variations of 10-g averaged SAR values for 835- and 900-MHz exposure in SAM phantom for adult and child with or without metal frame spectacles, for cheek and tilt positions of CP are given in fig. 5^{13, 14}.

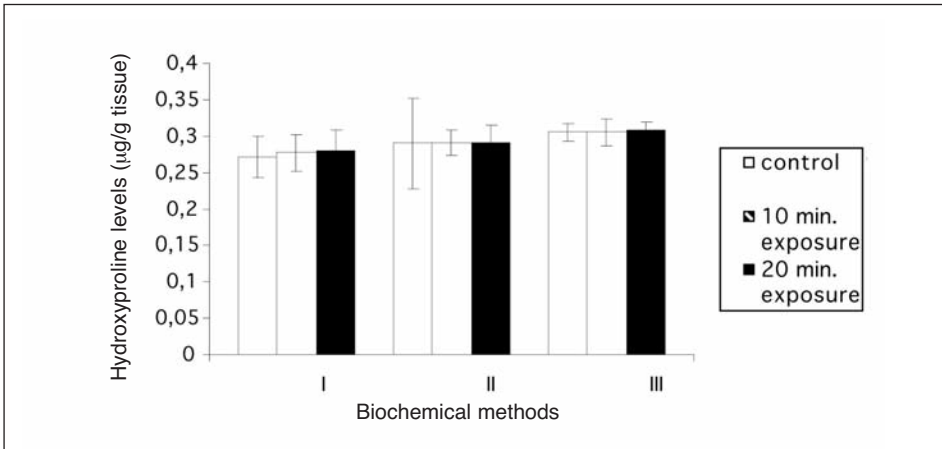

Fig. 3. Liver tissue hydroxyproline level determined by using three different biochemical methods. I: H. Stegemann-K. Stalder's method, II: I.S. Jamall-V.N. Finell's method and III: Method of ISO 3496

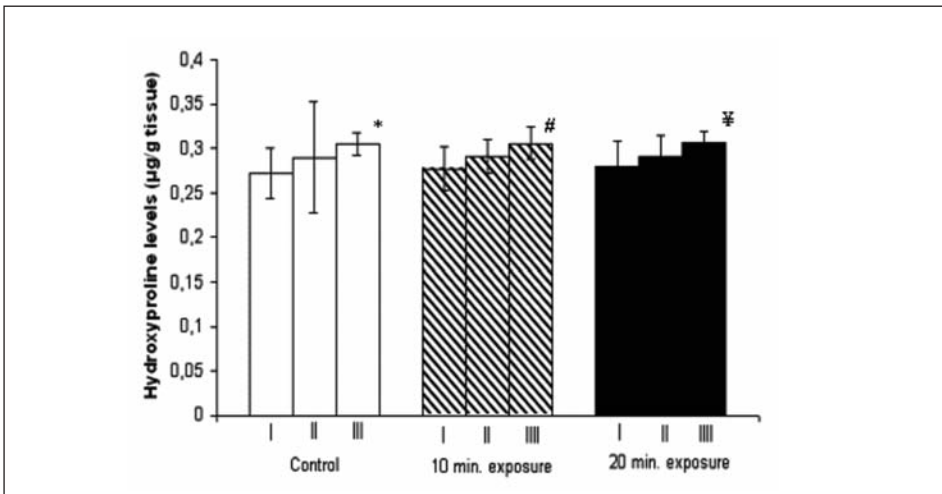

Fig. 4. Liver tissue hydroxyproline level determined by using three different biochemical methods for controls and exposure groups. I: H. Stegemann-K. Stalder's method, II: I.S. Jamall-V.N. Finell's method and III: Method of ISO 3496. *: $p < 0.05$ as compared to the hydroxyproline levels of controls determining by methods of I and II; #: $p < 0.05$ as compared to the hydroxyproline levels of 10 min. exposure determining by methods of I and II; ¥: $p < 0.05$ as compared to the hydroxyproline levels of 20 min. exposure determining by methods of I and II

It was found that usage positions of CP were the most significant parameter affecting SAR values. The obtained 10-g SAR values from the cheek positions were significantly more those that of tilt positions. Higher SAR values were determined on cheek position at both frequencies.

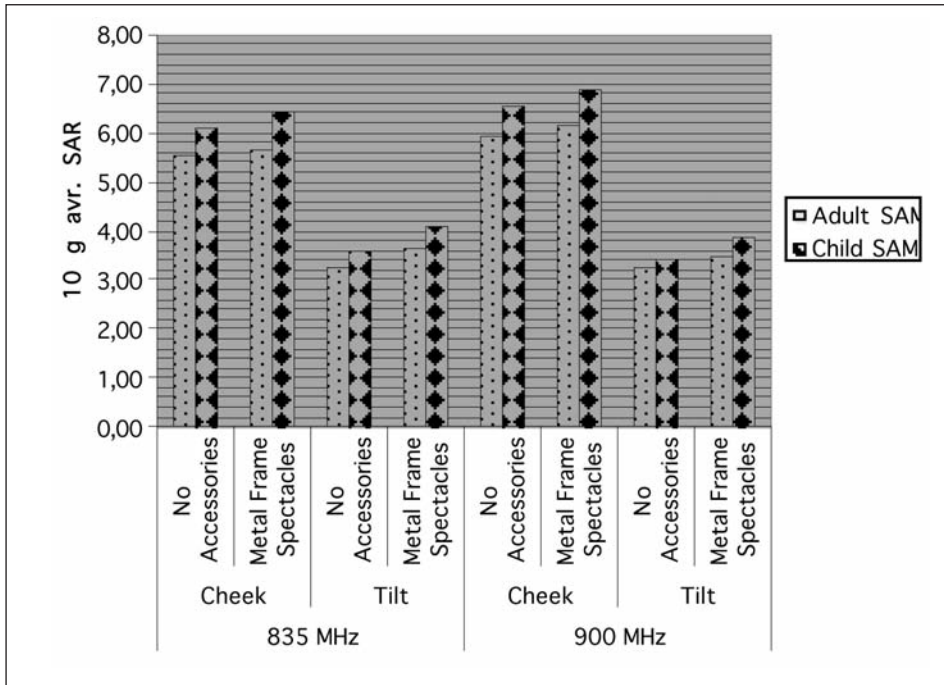

Fig. 5. Variations of peak SAR values for 835-MHz and 900-MHz RFR absorption in SAM phantoms for adult and child with or without metal frame spectacles, for cheek and tilt positions of CP

With the SAM phantom modeled for the child’s dielectric characteristics and head size, increased SAR values were determined compared to adults. The reason why this increase occurred may be the change in head sizes, but the main reason is the difference in dielectric characteristics between the child and the adult. In the condition of usage of metal frame spectacles, higher SAR values were determined both at the cheek and tilt positions at both 835 MHz and 900 MHz compared to having no spectacles. It was also observed that local SAR values were higher at the head model near to the spectacles. It might be resulted from the currents induced at the metal frame of the spectacles.

Discussion

Blood brain barrier study

Our results indicate that RFR at non-thermal levels can induce disruption of the BBB. Disturbances to the integrity of BBB and external influences on its functions are critical to central nervous function and could influence and accelerate neurodegenerative processes. One of the possible mechanisms for tumor development is increase in the permeability of BBB, which may result in the entry of carcinogenic substances into the brain.

Our results suggest that 20 minutes of acute exposure of young adult male rats to CW RFR cause disruption to BBB integrity, whereas no significant change was found for the

female rats. Gender differences have been reported for many structures and functions of central nervous system³⁸. Lin *et al.*³⁹ argued that EB dye in the rat brains is closely related to intense RFR hyperthermia. Wijsman and Shivers⁴⁰ demonstrated that BBB permeability to Horse Radish Peroxidase (HRP) was increased in response to heat stress. We present here evidence for BBB disruption caused by non-thermal RFR exposure. Our observation finds support in the work of Salford *et al.*⁴¹ which showed the short-term exposure effects of CW RFR on the BBB at non-thermal levels. It is unlikely that this increase of permeability in male exposed groups could be due to immobilization stress⁴², since animals were exposed to 900-MHz and 1800-MHz RFR under anesthesia. Prato *et al.*⁴³ shown a temporarily increase in BBB permeability to HRP under MRI procedure. Fritze *et al.*⁴⁴ investigated the effects of 900-MHz RFR exposure on the permeability of BBB for duration of 4 h at SAR ranging from 0.3, 1.5 and 7.5 W/kg. The increase in serum albumin extravasations after RFR exposure reached significance only in the group exposed to the highest SAR of 7.5 W/kg. Gruenau *et al.*⁴⁵ evaluated the effects of CW or pulsed RFR at a frequency of 2.8 GHz on the permeability of BBB of unanesthetized rats and the findings indicated that RFR radiation under the given experimental conditions did not damage BBB.

Possible mechanisms of disruption of BBB by RFR are still under discussion. Some authors suggest pinocytotic transport across the endothelial cells⁴⁶. Neubauer *et al.*⁴⁷ described that permeability increase of BBB to rhodamine-ferritin at whole body averaged SAR of 2 W/kg was almost blocked when rats were pretreated with colchicine. These results also suggest that pinocytotic mechanisms may be involved. Some authors argued that an increase of heat shock proteins (HSP) results in oxidative stress and this stress gives rise to brain tumors or the increase in the permeability of BBB^{48, 49}. RFR exposure might produce an increase in HSP level. Researchers are also discussing the link between RFR exposure and the changes of BBB permeability and headaches and the dopamine opiate systems of brain⁵⁰. An alternative explanation could be an opening of tight junctions or an increase of ornithine decarboxylase (ODC) activity which correlates with BBB disturbances⁵¹.

We conclude that our data support the hypothesis that 900-MHz and 1800-MHz CW RFR at non-thermal RFR levels is related to an increase in the permeability of BBB in young adult male rats.

Radio frequency radiation effect on collagen

Since 1960, collagen draws the scientists' interests because it has piezoelectric characteristics and could be affected by external and/or internal natural electromagnetic fields because of its electrical charge. There are researches that focused on effects of electromagnetic radiation on collagen in several tissues but most are related with electric current, static, and ELF electromagnetic fields^{2-8, 52-61}. In addition to these studies, some studies also investigated RFR effect on collagen. For instance, Masuda *et al.*⁹ studied on hairless female rats exposed or sham-exposed for 2 h to GSM 900 or GSM 1800 signals, using a loop-antenna located on the right part of the rats' back. The local Specific Absorption Rate (SAR) at skin level was approximately 5 W/kg. Results on filaggrin, collagen and elastin levels showed an insignificant influence of RFR. Ozguner *et al.*¹⁰ investigated the effects of 900-MHz RFR on the induction of histopathologic changes in skin and they found increased thickness of stratum corneum, atrophy of epidermis, papillomatosis, basal cell proliferation, increased granular cell layer (hyper-

granulosis) in epidermis and capillary proliferation, impairment in collagen tissue distribution and separation of collagen bundles in dermis.

In the present study, effects of RFR generated by GSM 1800 mobile phones on liver tissue collagen were examined by using three different hydroxyproline detection methods. The outcome of the biochemical analysis pointed out that RFR did not significantly affect hydroxyproline level.

Since this is a pioneer study on the effect of mobile phone radiation on hydroxyproline level, using three different methods was needed to ensure validity. In addition to this, collagen composed of the amino acids: glycine (33.5 %), proline (12%) and hydroxyproline (10%), so especially liver hydroxyproline level determination is a difficult procedure because of low level of tissue collagen (4%). In the light of our evidences, hydroxyproline levels obtained by using ISO 3496 method is statistically more significant than the other two methods ($p < 0.05$). In this study, "H. Stegemann-K. Stalder", "I.S. Jamall-V.N. Finell" and "ISO 3496" were chosen as biochemical methods of liver tissue hydroxyproline level determination after literature search. In each of these three methods, tissue hydrolysis of hydroxyproline was measured by spectrometry after adding Chloramin-T reactive which stains the solution. "ISO 3496" is a method which is nowadays used for determining the absolute value of hydroxyproline in the meat and meat product industry which should be very little collagen content in order to be fine product.

Even though our findings of hydroxyproline levels in liver tissue of RFR-exposed guinea pigs were statistically insignificant with respect to controls. A question to be asked is what would be the consequence of longer duration or prolonged exposure. It would be interesting to study prolonged exposure in further research.

SAR simulations of adult and child head

There is a rapid increase in the usage of wireless communication. While the working frequency of the cellular phone increases, the value of the SAR increases¹⁵. In this study, SAR values resulted by CP operating in 835-MHz and 900-MHz frequency bands were calculated in human head models for both adult and child. Moreover, the feature of this study gives a chance to compare the SAR levels resulted by the frequencies of 835 MHz and 900 MHz which are the CP operating frequencies of Europe and USA.

CPs were positioned near the head models in two positions according to IEEE 1528-2003, IEC 62209-1 2005 standards. In the first condition, CP was located near the cheek, and at the second one, CP was in tilt position. Consequently, SAR level was found to be less in the tilt position than the condition that CP was near the cheek. Our results are consistent with the results of other studies in the literature¹⁵. SAR level in the tilt position of CP was 40% less than the cheek position of CP for 835 MHz. Furthermore, this decrease was 55% for 10 g SAR value for 900 MHz frequency. This may be caused by the location of the current density in phone chassis being closer to the head phantom in the cheek position of CP.

Children of the growing age are more vulnerable to influence of environmental factors. Because of the size of children's head and their dielectric properties, their RF radiation dose rates caused by CP usage are higher than adults. For this reason, scaled head models are usually used for children head simulation. Gandhi et al¹⁸ studied with scaled head models for the 5-year-old and the 10-year-old children for simulating the effect of CP with $\lambda/4$ monopole antenna operating both at 835-MHz and 1900-MHz

frequency bands. They reported that 1 g peak spatial average SAR at 835 MHz frequency was 50% increased in the scaled model of the 5-year-old child head¹⁸.

De Salles *et al.* found that 1 g peak spatial average SAR increased by 60% in the scaled model of 10-year-old child head exposed to CP with patch antenna and $\lambda/4$ monopole antenna at the operation frequencies of 835 MHz and 1850 MHz⁶².

In this study, a significant increase was found in the child SAM phantom, modeled according to the dielectric properties of the children with respect to the adult model. 10 g peak spatial average SAR increases for 835 MHz and 900 MHz were calculated as 10% in the cheek position. It was determined that increasing ratios were 10% for 835 MHz and 6% for 900 MHz in the tilt position of CP.

It should be considered that children will be affected from CP more than adults and they should have precaution in using this technology.

According to the SAR calculated in this study, it is observed that the positioning of CP is the most effective parameter affecting SAR level. The spectacles, one of the most widely used accessories in daily life may be one of the important parameters that affect SAR values. Furthermore, sensitive organs like the eye can be exposed to high SAR because of the induced current at the spectacles. The rectangular metal frame spectacles used in this modeling study have a perfect electrical conductivity. Simulation revealed that metal frame spectacles increased the spatial peak SAR for 835-MHz and 900-MHz frequencies as 2-3% in cheek position, but this increase was 7-11.5% in CP's tilt position. In addition to this, it was observed that local SAR levels in the head model near spectacles were high.

SAR calculations for the studies of BBB and collagen synthesis is planned to be evaluated in our further study.

Acknowledgements

RFR measurements were performed with devices purchased by a grant from the Gazi University Research Foundation, Project No: 01/2003-62.

BBB study was supported by a grant from the Gazi University Research Foundation, Project No: 01/2005-78.

Study of "Analysis of Radio Frequency Radiation Effect on Collagen" was funded by a grant from the Gazi University Research Foundation, TF.01/2004-04.

SAR study was supported by the Gazi University Scientific Research Grant SBE-01/2006-22.

References

1. Nittby H, Grafström G, Eberhardt JL, *et al.* Radiofrequency and extremely low-frequency electromagnetic field effects on the blood-brain barrier. *Electromagn Biol Med* 2008; 2: 103-26.
2. Atalay Seyhan, N. Does electric field effect collagen synthesis in tissue. *Gazi Medical Journal* 1995; 6: 1-6.
3. Canseven A. The Effect of magnetic fields with different application times and different magnitudes on skin hydroxyproline level, Gazi University Health Sciences Institute Biophysics Department, (PhD thesis with the supervision of Dr. Nesrin Seyhan), Ankara, Turkey, 1998.
4. Güler G. The Effect of AC electric field with different application times on the protein synthesis, Gazi University Health Sciences Institute Biophysics Department, (PhD thesis with the supervision of Dr. Nesrin Seyhan), Ankara, Turkey, 1998.
5. Güler G, Seyhan Atalay N, Özoğul C, *et al.* Biochemical and structural approach to collagen synthesis under electric fields. *Gen Physiol Biophys* 1996; 15: 429-40.
6. Güler G, Atalay Seyhan N. Changes in hydroxyproline levels in electric field tissue interaction. *Indian Journal of Biochemistry and Biophysics* 1996; 33: 531-3.

7. Seyhan N, Canseven AG. In vivo effects of ELF MFs on collagen synthesis, free radical processes, natural antioxidant system, respiratory burst system, immune system activities, and electrolytes in the skin, plasma, spleen, lung, kidney, and brain tissues. *Electromagn Biol Med* 2006; 25: 291-305.
8. Seyhan N, Guler G. Review of in vivo static and ELF electric fields studies performed at Gazi Biophysics Department. *Electromagn Biol Med* 2006; 25: 307-23.
9. Masuda H, Sanchez S, Dulou PE, *et al.* Effect of GSM-900 and -1800 signals on the skin of hairless rats. I: 2-hour acute exposures. *Int J Radiat Biol* 2006; 82: 669-74.
10. Ozguner F, Aydin G, Mollaoglu H, *et al.* Prevention of mobile phone induced skin tissue changes by melatonin in rat: an experimental study. *Toxicol Ind Health* 2004; 20: 133-9.
11. Ozgur E. Variation in Mobile Phone Radiation with Voices of Different Frequencies and Strengths, Effects on Tissue Hydroxyproline Level, Gazi University Health Sciences Institute Biophysics Department, (MSc thesis with the supervision of Dr. Göknur Güler), Ankara, Turkey, 2006.
12. Chou CK, Bassen H, Osepchuk J, *et al.* Radio frequency electromagnetic exposure: tutorial review on experimental dosimetry. *Bioelectromagnetics* 1996; 17(3): 195-208.
13. Tuysuz MZ. Determination of mobile phone exposure based RF dosimetry by using FDTD methods, MSc thesis, Gazi University Health Sciences Institute Biophysics Department, (MSc thesis with the supervision of Dr. Canseven A.G.), Ankara, Turkey, 2007.
14. Tuysuz MZ, Canseven AG. Comparison of SAR Values for Child and Adult Head Models due to Different Usage Conditions in 835 MHz And 900 MHz Cellular Phones. The Bioelectromagnetics Society 30th Annual Meeting. San Diego, California, USA, 2008; 190-2.
15. Beard BB, Kainz W, Onishi T, *et al.* Comparisons of computed mobile phone induced SAR in the SAM phantom to that in anatomically correct models of the human head. *IEEE Transaction on Electromagnetic Compatibility* 2006; 48: 397-407.
16. Wiart J, Hadjem A, Gadi N, *et al.* Modeling of RF head exposure in children. *Bioelectromagnetics* 2005; Suppl 7: S19-30.
17. Gandhi OP, Kang G. Some present problems and a proposed experimental phantom for SAR compliance testing of cellular telephones at 835 and 1900 MHz. *Phys Med Biol* 2002; 47(9): 1501-18.
18. Gandhi OP, Lazzi G, Furse CM. Electromagnetic absorption in the human head and neck for mobile telephones at 835 and 1900 MHz. *IEEE Trans Microw Theory Tech* 1996; 44: 1884-97.
19. Peyman A, Rezazadeh AA, Gabriel C. Changes in the dielectric properties of rat tissue as a function of age at microwave frequencies. *Phys Med Biol* 2001; 46(6): 1617-29.
20. Gabriel C. Dielectric properties of biological tissue: variation with age. *Bioelectromagnetics* 2005; Suppl 7: S12-8.
21. Sirav Aral B. Effects of 900 MHz and 1800 MHz Radio Frequency Radiation on Blood-Brain Barrier, PhD thesis, Gazi University, Institute of Health Sciences, Department of Biophysics, (PhD thesis with the supervision of Prof. Dr. Nesrin Seyhan), Ankara, Turkey, 2008.
22. Sirav Aral B, Seyhan N. CW 900 MHz and CW 1800 MHz EMF Alter Blood-Brain Barrier Permeability. Proceedings of International EMF Conference, Electromagnetic Fields, Bioeffects Research, Medical Applications, and Standards Harmonization. Kuala Lumpur, Malaysia, 2007-a; 161.
23. Sirav Aral B, Seyhan N. Radio Frequency Radiation (RFR) Effects on Blood Brain Barrier (BBB) of Female Rats. Proceedings of International EMF Conference, Electromagnetic Fields, Bioeffects Research, Medical Applications, and Standards Harmonization. Kuala Lumpur, Malaysia, 2007-b; 129-31.
24. Guidelines for limiting exposure to time-varying electric, magnetic, and electromagnetic fields (up to 300 GHz). International Commission on Non-Ionizing Radiation Protection (ICNIRP). *Health Phys* 1998; 74(4): 494-522.
25. Kaya M, Cimen V, Kalayci R, *et al.* Catalase and α -Tocopherol Attenuate blood brain barrier breakdown in pentylenetetrazole-induced epileptic seizures in acute hyperglycaemic rats. *Pharmacological Research* 2002; 45: 129-33.
26. Sirav B, Seyhan N. Blood-Brain Barrier Disruption by Continuous Wave Radio Frequency Radiation. *Electromagnetic Biology and Medicine* 2009; 28: 215-22.
27. Ozgur E, Güler G. No effect of 1800 MHz RFR to collagen synthesis to Guinea Pig liver tissue, proceedings. In: Kostarakis P, ed. Proceedings of the 4th International Workshop on Biological Effects of EMFs, Vol. II. Crete, Greece, 16-20 October 2006, 1110-3.
28. Stegemann H, Fuchs G, Eger W. Der Transplantierte Knochenspan und Seine Qualität Nach

- Partieller und Vollständiger Enteiweibung Bei Erhaltener Anorganischer Substanz. Arch Klin Chir 1963; 303: 240-60.
29. Stegemann H, Stalder K, Bernhard G. Über die Isomerisierung von Hydroxyprolin. Hoppe- Seyler's Z. Physiol Chem 1964; 337: 179-85.
 30. Stegemann H, Stalder K. Determination of Hydroxyproline. Clin Chim Acta 1967a; 18: 267-73.
 31. Stegemann H, Stalder K. Zur Ausscheidung von Hydroxyprolin im Harn. Hoppe- Seyler's Z. Physiol Chem 1967b; 348: 242-3.
 32. Jamall IS, Finelli VN, Que Hee SS. A simple method to determine nanogram levels of 4-hydroxyproline in biological tissues. Anal Biochem 1981; 112: 70-5.
 33. ISO 3496. Meat and meat products - Determination of hydroxyproline content, International Organization for Standardization, 1997.
 34. Beard BB, Kainz W. Review and standardization of cell phone exposure calculations using the SAM phantom and anatomically correct head models. Biomed Eng Online 2004; 3(1): 34.
 35. Wang J, Fujiwara O. Comparison and evaluation of electromagnetic absorption characteristic in realistic human head models of adult and children for 900-MHz mobile telephones. IEEE Transaction on Microwave Theory and Techniques 2003; 51: 966-71.
 36. IEC Standard 62209-1. Human Exposure to Radio Frequency Fields from Hand-Held and Body-Mounted Wireless Communication Devices- Human Models, Instrumentation and Procedures-Part I: Procedure to Determine the Specific Absorption Rate (SAR) for Hand-Held Devices Used in Close Proximity to the Ear (Frequency Range of 300 MHz to 3 GHz), 2005.
 37. IEEE Standard 1528. Recommended Practice for Determining the Peak Spatial-Average Specific Absorption Rate (SAR) in the Human Head from Wireless Communications Devices: Measurement Techniques, 2003.
 38. Oztas B. Sex and blood-brain barrier. Pharmacol Res 1998; 37(3): 165-7.
 39. Lin JC, Yuan PMK, Jung DT. Enhancement of anticancer drug delivery to the brain by microwave induced hyperthermia. Bioelectrochem Bioenerg 1998; 47: 259-64.
 40. Wijsman JA, Shivers RR. Heat stress affects blood brain barrier permeability to horseradish peroxidase in mice. Acta Neuropathol 1993; 86(1): 49-54.
 41. Salford LG, Brun A, Stureson K, *et al.* Permeability of the blood brain barrier induced by 915 MHz electromagnetic radiation, continuous wave and modulated at 8, 16, 50 and 200 Hz. Microsc Res Tech 1994; 27(6): 535-42.
 42. Shivers RR, Pollock M, Bowman PD, *et al.* The effects of heat shock on primary cultures of brain capillary endothelium: inhibition of assembly of zonulae occludentes and the synthesis of heat shock proteins. Eur J Cell Biol 1988; 46(1): 181-95.
 43. Prato FS, Frappier JR, Shivers RR, *et al.* Magnetic Resonance Imaging increases the blood brain barrier permeability to 153-Gadolinium Diethylenetriaminepentaacetic acid in rats. Brain Res 1990; 523(2): 301-4.
 44. Fritze K, Sommer C, Schmitz B, *et al.* Effect of global system for mobile communication (GSM) microwave exposure on blood brain barrier permeability in rat. Acta Neuropathol 1997; 94(5): 465-70.
 45. Gruenau SP, Oscar KJ, Folker MT, *et al.* Absence of microwave effect on blood-brain barrier permeability to [14C] sucrose in the conscious rat. Exp Neurol 1982; 75: 299-307.
 46. Shivers RR, Kavaliers M, Teskey GC, *et al.* Magnetic Resonance Imaging temporarily alters blood brain barrier permeability in the rat. Neurosci Lett 1987; 76(1): 25-31.
 47. Neubauer C, Phelan AM, Kues H, *et al.* Microwave irradiation of rats of 2.45 GHz activates pinocytotic like uptake of tracer by capillary endothelial cells of cerebral cortex. Bioelectromagnetics 1990; 11(4): 261-8.
 48. Meral I, Mert H, Mert N, *et al.* Effects of 900-MHz electromagnetic field emitted from cellular phone on brain oxidative stress and some vitamin levels of guinea pigs. Brain Res 2007; 1169: 120-4.
 49. Leszczynski D, Joenväärä S, Reivinen J, *et al.* Non-thermal activation of the hsp 27/p38MAPK stress pathway by mobile phone radiation in human endothelial cells: molecular mechanism for cancer and blood-brain barrier related effects. Differentiation 2002; 70: 120-9.
 50. Frey AH. Headaches from cellular telephones: are they real and what are the implications? Environ Health Perspect 1998; 106(3): 101-3.
 51. Koenig H, Goldstone AD, Lu CY, *et al.* Polyamines and Ca⁺² mediate hyperosmolal opening of the

- blood brain barrier in vitro studies in isolated rat cerebral capillaries. *J Neurochem* 1989; 52: 1135-42.
52. Ahmadian S, Zarchi SR, Bolouri B. Effects of extremely-low-frequency pulsed electromagnetic fields on collagen synthesis in rat skin. *Biotechnol Appl Biochem* 2006; 43(Pt 2): 71-5.
 53. Binhi VN, Goldman RJ. Ion-protein dissociation predicts 'windows' in electric field-induced wound-cell proliferation. *Biochim Biophys Acta* 2000; 1474: 147-56.
 54. Ciombor DM, Aaron RK. The role of electrical stimulation in bone repair. *Foot Ankle Clin* 2005; 10: 579-93.
 55. Digel I, Kurulgan E, Linder P, *et al.* Decrease in extracellular collagen crosslinking after NMR magnetic field application in skin fibroblasts. *Med Biol Eng Comput* 2007; 45: 91-7.
 56. Farndale RW, Murray JC. Pulsed electromagnetic fields promote collagen production in bone marrow fibroblasts via athermal mechanisms. *Calcif Tissue Int* 1985; 37: 178-82.
 57. Hirose H, Nakahara T, Miyakoshi J. Orientation of human glioblastoma cells embedded in type I collagen, caused by exposure to a 10 T static magnetic field. *Neurosci Lett* 2003; 338: 88-90.
 58. Huang HM, Lee SY, Yao WC, *et al.* Static magnetic fields up-regulate osteoblast maturity by affecting local differentiation factors. *Clin Orthop Relat Res* 2006; 447: 201-8.
 59. Ottani V, De Pasquale V, Govoni P, *et al.* Effects of pulsed extremely-low-frequency magnetic fields on skin wounds in the rat. *Bioelectromagnetics* 1988; 9: 53-62.
 60. Quaglino D, Capri M, Zecca L, *et al.* The effect on rat thymocytes of the simultaneous in vivo exposure to 50-Hz electric and magnetic field and to continuous light. *Scientific WorldJournal* 2004; 4: 91-9.
 61. Sakai Y, Patterson TE, Ibiwoye MO, *et al.* Exposure of mouse preosteoblasts to pulsed electromagnetic fields reduces the amount of mature, type I collagen in the extracellular matrix. *J Orthop Res* 2006; 24: 242-53.
 62. De Salles AA, Bulla G, Rodriguez CE. Electromagnetic absorption in the head of adults and children due to mobile phone operation close to the head. *Electromagn Biol Med* 2006; 25(4): 349-60.

Effects of microwave radiation upon the mammalian blood-brain barrier

Leif G. Salford*, Henrietta Nittby*, Arne Brun**, Jacob Eberhardt***, Lars Malmgren****, Bertil R.R. Persson***

* Department of Neurosurgery, Lund University, Lund, Sweden

** Department Neuropathology, Lund University, Lund, Sweden

*** Department Medical Radiation Physics, Lund University, Lund, Sweden

**** Applied Electronics, Lund University, Lund, Sweden

Abstract

Our research group has studied the effects of electromagnetic fields (EMF) upon the mammalian brain (rats) since 1988. Our major field of interest during the period has been the effects upon the blood-brain barrier (BBB) of the rat. The mammalian brain is protected by the BBB from potentially harmful compounds circulating in the blood. In the normal brain, the passage of compounds over the BBB is highly restricted. Our studies have revealed that the EMF radiation of the kind emitted by mobile phones leads to increased permeability of the BBB both immediately after 2 hours of exposure, but also after 7 days, 14 days and 50 days, all at non-thermal exposure levels. Also, damaging effects from radiofrequency EMF upon neurons has been shown after 28 days and 50 days. Of what is known today, the human BBB is very similar to the rodent BBB. With our research into the field, and comparison to other studies of BBB permeability in connection to EMF exposure, it is our sincere belief, that it is more probable than unlikely, that non-thermal EMF from mobile phones and base stations do have effects upon the human brain.

***Key words:* blood-brain barrier, dark neurons, electromagnetic fields, mobile phone, rats**

Introduction

The environment for life on Earth has changed dramatically during the last decades. During the billions of years when life was formed, it was shaped to function in harmony with the naturally occurring physical forces such as gravitation, cosmic irradiation, heat and cold, mechanical forces and the terrestrial magnetism.

The power density of the microwave (MW) background in space is about $0.4 \mu\text{W}/\text{m}^2$, as obtained by integration of recorded spectral data. This results in a power density of

Address: Leif G. Salford, Department of Neurosurgery, Lund University Hospital SE-221 85 Lund, Sweden - Tel. 46-46-171270 - Fax 46-46-188150 - E-mail: leif.salford@med.lu.se

an extremely low natural MW background on earth, estimated to be in the order of 10^{-15} to 10^{-8} $\mu\text{W}/\text{m}^2$.

Artificial MWs were not produced by humans until 1886. At that point, the German physicist Heinrich Hertz was the first to broadcast and receive radio waves. From then on, MWs have been the carriers of telegraphic data between stations on Earth and also between ground-based stations and satellites. In the 1950's, the high frequency Radio Frequency (RFs) became increasingly used as FM and television. Then the use of MWs in the mobile phone communications society has expanded drastically. Today about half of the world's population is owners of mobile phones, and an even larger number are exposed to the MW fields through the passive mobile phoning and MW-emitting base stations placed everywhere around us. All this results in an artificially produced general MW background in our environment in the order of 10^{11} to 10^{18} times the levels generated by the MW background radiation from space. The important question is, whether the exposure to these omnipresent MWs is only of good. The generation of today is the first to be exposed during a whole lifetime. Possibly, this may result in harmful effects. If so, these must be studied, revealed and reduced or avoided.

Our research group has studied the effects of EMF upon the mammalian brain (rats) since 1988. In later years we have included studies on cognition and gene expression where we have demonstrated significant effects of exposure to RF-EMF from mobile phones. However, our major field of interest during the period has been the effects upon the blood-brain barrier (BBB) of the rat. These studies have also revealed damaging effects from RF-EMF upon neurons. We report here our results on BBB effects and to a lesser extent on neuronal damage.

Review of the literature

The blood-brain barrier

The existence of the BBB was discovered in the late 19th century by the German bacteriologist Paul Ehrlich and his student, Edwin Goldman. Paul Ehrlich found, that when he injected dyes into the systemic blood circulation, the brain tissue did not take up any of the staining. However, Goldman described in 1909 that the brain tissue was stained after direct injection of trypan blue into the brain ventricular systems. A barrier surrounding the brain tissue at the site of the brain micro vessels seemed to be a logic explanation to these findings.

Today, it is well known that the mammalian brain is protected from potentially harmful compounds circulating in the blood by the BBB. In the normal brain, the passage of compounds over the BBB is highly restricted. Other barriers in the mammalian body include the eye (a protrusion of the brain), the blood-testis-barrier, the ovarian blood-follicle barrier and the less restrictive placental barrier.

A BBB exists not only in vertebrates, but also in insects¹, crustaceans and cephalopod molluscs (such as the cuttlefish)² and in elasmobranchs (cartilaginous fishes such as sharks)³ and helices (landsnails)⁴, maintaining ionic integrity of the neuronal bathing fluid. Several studies describe well developed blood-barrier functions in these invertebrates where the similarities with the vertebrate BBB are striking.

Anatomy of the mammalian blood-brain barrier

The BBB is formed by the vascular endothelial cells in the capillaries of the brain with glial cells wrapped around. The endothelial cells are sealed together with tight junctions, composed of the tight junction proteins occludin, claudin and zonula occludens⁵. No fenestrations are left between the endothelial cells (fig. 1).

The abluminal membrane of the capillary surface is covered to 25% by pericytes⁶. The pericytes are a type of macrophages, with macrophage markers and capacity for phagocytosis and antigen presentation and seemingly, they are in a position to significantly contribute to central nervous system (CNS) immune mechanisms. They help maintain the stability of blood vessels by regulating the endothelial cells and the vascular permeability⁷.

Surrounding the endothelial cells and the pericytes, there is a bilayer basal membrane. This basement membrane (basal lamina) supports the abluminal surface of the endothelium and may act as a barrier to the passage of macromolecules.

The outer surface of the basal membrane is surrounded by protoplasmic astrocytes. These are implicated in the maintenance, functional regulation and repair of the BBB. Their protrusions, called end feet, cover the basal membrane and form a second barrier to hydrophilic molecules, but also connect the endothelium to the neurons.

The BBB is not only a physical barrier, but is also an enzymatic barrier with the capability of metabolizing certain solutes, such as drugs and nutrients⁸. Many of these enzymes reside selectively in the cerebral endothelial cells. For instance, enzymes like monoamine oxidase A and B, catechol O-methyltransferase, or pseudocholinesterase are involved in the degradation of neurotransmitters present in the CNS⁹.

Differences between the human and the rodent BBB

The mammalian brain at large seems to have a uniform anatomy of its BBB constituents preserved through the evolution, and very little information about differences between mammalian species has been available. However, recently very inter-

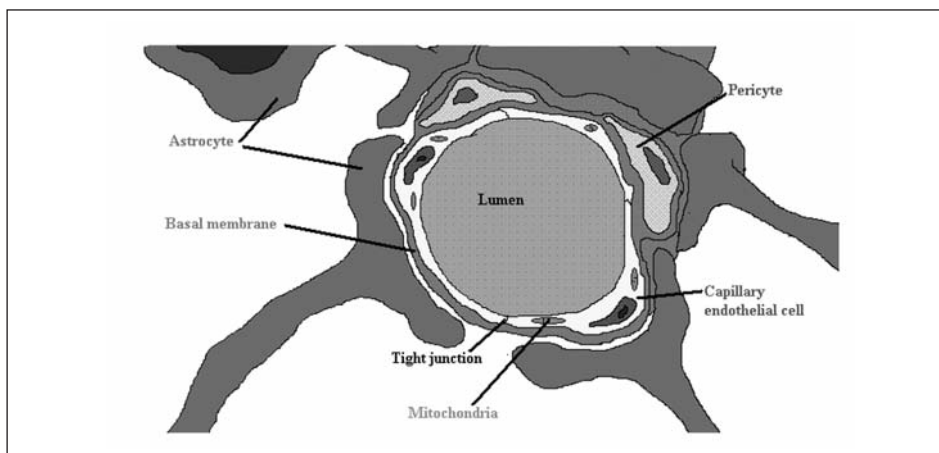

Fig. 1. The mammalian BBB

esting observations have been published. Humans have evolved protoplasmic astrocytes that are both larger (27-fold greater volume) and far more elaborate than their rodent counterparts. These astrocytes reside near blood vessels, and their processes contribute to the BBB¹⁰. When the end feet of human and rodent protoplasmic astrocytes are compared, it is shown that nearly all astrocytes in both species contact the vasculature, but in the human brain, the end feet completely encompass the vessels while the rodent astrocytes form rosettes of end feet around the vasculature. The number of mitochondria is however equally abundant in human and rodent end feet¹¹. Even if the endothelial cells are considered as the major component of the BBB, it cannot be excluded that the observed astrocytic differences may be of importance for how the EMFs affect the BBB in rodents vs humans.

Comparisons between mammalian species concerning enzymatic functions in the BBB are few in number. Similarities are described: mouse vs human¹² and rat vs human¹³, while differences are demonstrated between rodent and dog BBB leading to the conclusion that the canine BBB may be preferable to that of the rat as a model for studies of glucose transport relevant to human brain¹⁴.

Transport across the blood-brain barrier

The microvasculature of the CNS differs physiologically from that of peripheral organs. The endothelial cells are characterised by the low number of pinocytic vesicles for nutrient transport through the cytoplasm and they have a five-fold higher number of mitochondria as compared to the muscular endothelium¹⁵.

The size and hydrophobic or hydrophilic characteristics of substances affect whether or not they can pass the BBB:

- water, most lipid-soluble molecules, oxygen and carbon dioxide can diffuse from blood to the nerve cells;
- the BBB is slightly permeable to ions such as Na⁺, K⁺, Cl⁻;
- proteins and most water-soluble chemicals pass poorly.

The flux of solutes into the brain parenchyma can be controlled by at least four mechanisms. First, the tight junctions and low number of pinocytic vesicles guarantee that proteins cannot pass freely into the brain parenchyma. Second, solutes which are not highly lipid soluble, or which do not bind to selective transporters with high affinity, are excluded from free exchange. Thus, the passage of sugars and many aminoacids depends on other, active mechanisms. Third, the BBB has a capacity to metabolize certain solutes, such as drugs and nutrients⁸. Fourth, active transporters maintain the levels of certain solutes at specific values within the brain interstitial fluid. This is made possible by active transport against the concentration gradients. These enzyme systems are differently distributed between the luminal and the abluminal membranes of the endothelial cells, thus gaining the BBB polarity properties.

For the substances, which cannot diffuse over the BBB, certain mechanisms could be used to pass the BBB. These include:

- paracellular routes;
- transcellular routes, with pinocytosis or transcytosis, transendothelial channels, or disruption of endothelial cell membrane.

During certain pathological conditions, the selective permeability of the BBB is disturbed, resulting in a temporary increased BBB permeability. Such conditions include tumours, infarcts, infections or traumas. The BBB itself might play an active role in the

mediation of the neuroimmune response seen in different conditions, by production of inflammatory mediators or by the expression of adhesion molecules⁹. The selective permeability of the BBB is altered also in cases of epileptic seizures^{16, 17} and severe hypertension¹⁸. The result of this can be cerebral oedema, increased intracranial pressure and irreversible brain damage. Also, toxic substances from the blood circulation now reach the neurons.

In the study by Sokrab *et al.*¹⁸, hypertensive opening of the BBB was induced by clamping the upper abdominal aorta in rats for 8-10 minutes. BBB leakage was demonstrated in all 3 rats surviving 2 hours after the clamping and in 5/12 rats sacrificed 7 days after the clamping, although the intensity in the BBB leakage had been reduced in the animals with a 7-day recovery time. The BBB leakage could be visualised in cortex, basal ganglia, hippocampus, cerebellum and the brain stem. Also, importantly, it was concluded that even transient openings of the BBB can lead to permanent tissue damage¹⁸.

There is a time-dependence regarding insults leading to BBB opening. Hardebo evaluated the scale for opening and closure of the BBB after a reversible opening, achieved by a hypertensive or hyperosmolar insult¹⁹. The degree of Evans blue-albumin complex was estimated by gross inspection of the brain surface, and extravasation of inulin and noradrenaline was expressed as tissue radioactivity quotient. The absolute values for extravasation of inuline and noradrenaline were very similar, and all three test substances had an identical time profile. Thirty minutes after the hypertensive insult and 60 minutes after the hypertonic insult, the barrier was reclosed. With electron micrographs of the microvessels of the cortex, micro-pinocytotic vesicles within endothelial cells were seen. Also, vesicles were being formed and disintegrated in the luminal membranes of the endothelial cells. This increased transendothelial pinocytosis was observed as long as the barrier was open.

Hardebo and Nilsson also found that intracarotid infusions of hyperosmolar solutions induced cerebral vasodilatation and flow increase²⁰. It was proposed that BBB opening caused by the acute hypertension could be related to a pressure-forced over-distension of the vessels along the vascular tree, and that increased transendothelial pinocytosis under these experimental conditions might be due to the dilatation and/or distension of the brain vessels.

The importance of the BBB is also revealed by its presence not only in vertebrates, but also in invertebrates. For instance, a glial vertebrate-like BBB has been found in scorpions²¹. Using radio-labelled polyethylene glycol and EDTA it was shown that the cuttlefish *Sepia* has a BBB as tight as the endothelial barrier of mammals². Furthermore, it was concluded that the *Sepia* BBB is formed by perivascular glial processes in the microvessels and venous vessels, but by pericytes in the arterial vessels. Possibly, the glial BBB could be the primitive condition and a barrier associated with vascular elements such as endothelium or pericytes could be a later development²².

Importantly, the BBB seems to be present very early in the foetal development. Also, at an early stage, there seems to be a cerebrospinal fluid barrier, which excludes cerebrospinal fluid (CSF) protein from the brain extracellular space²³. By measuring the protein composition and concentrations in the CSF and plasma of *Mondelphis domestica*, a small rodent-like marsupial, from birth until adulthood, it was found that protein content increased during day 5 and 10 after birth, and later on decreased and reached very low levels. Notably, these marsupials are born at a very early stage of their development, when almost all organ systems are at an embryonic level of development. This

is different from many other animals, in which the development has reached a much more mature stage at the time of birth; for example, in rats the peak concentrations of proteins within the CSF are reached at birth or just before/after this, the protein content is kept low.

Electromagnetic fields

EMFs are produced by the mutual interaction of electric and magnetic fields; by the movement of a charge generating a magnetic field or a changing magnetic field generating an electric field. An Electromagnetic (EM) wave is characterised by its intensity (the amplitude), the frequency of the time variations of the electric and magnetic fields, the pulse width and the number of pulses per second. The different frequencies of EMFs result in a spectrum ranging from 1,000 MHz (10^9 cycles per second) to 300,000 MHz (3×10^{11} cycles per second) and with wavelengths between 1 mm and 1 m.

An EMF spreads indefinitely in the empty space. Any charged object in the vicinity of this field is affected by the electromagnetic interactions. The result of this interaction depends on the amplitude of the field, but also seemingly weak amounts of electromagnetism can mediate significant effects through resonance interactions with sensitive systems.

The rate of EM energy absorbed in tissue per unit mass is called specific absorption rate (SAR). The maximally allowed SAR-value for occupational exposure is 10 W/kg, and 2 W/kg is the maximally allowed SAR-value for public exposure (localized SAR, head and trunk) according to limit values from the International Commission of Non-Ionizing Radiation Protection²⁴. These values are set in order to avoid thermal effects of the EMF radiation, such as whole-body heat stress and excessive localized tissue heating.

In our laboratory, in order to generate uniform EMFs for standard measurements, we have used transverse electromagnetic transmission line chambers (TEM-cells) in the majority of our experiments on rats²⁵⁻³². In each TEM-cell, two animals can be placed, one in an upper compartment and one in a lower compartment (fig. 2). It is important to point out that the position of the animals in upper or lower compartments does not effect the magnitude of observed albumin leakage. Also, we have concluded, with our total series of more than 2000 exposed animals, that there is no difference in the sensitivity to EMF exposure between male and female animals as far as albumin leakage is concerned.

The TEM-cells have mainly been used for exposure in the 900 MHz range. For generation of 1800 MHz-fields, an anechoic chamber has been used³³. The EMFs are generated by means of a directional antenna placed in the top part of the anechoic chamber.

The experimental models used in our studies allow the animals, which are un-anaesthetized during the whole exposure, to move and turn around in the exposure chambers, thus minimising the effects of stress induced immobilization³⁴.

Early studies of electromagnetic field induced blood-brain barrier permeability

Already in 1968, Frey, a pioneer in the field, noted that "in recent years it has been recognized that low-power-density modulated RF energy can affect the functioning of higher living organisms". In the 1970's, he discussed possible mechanisms by which RF

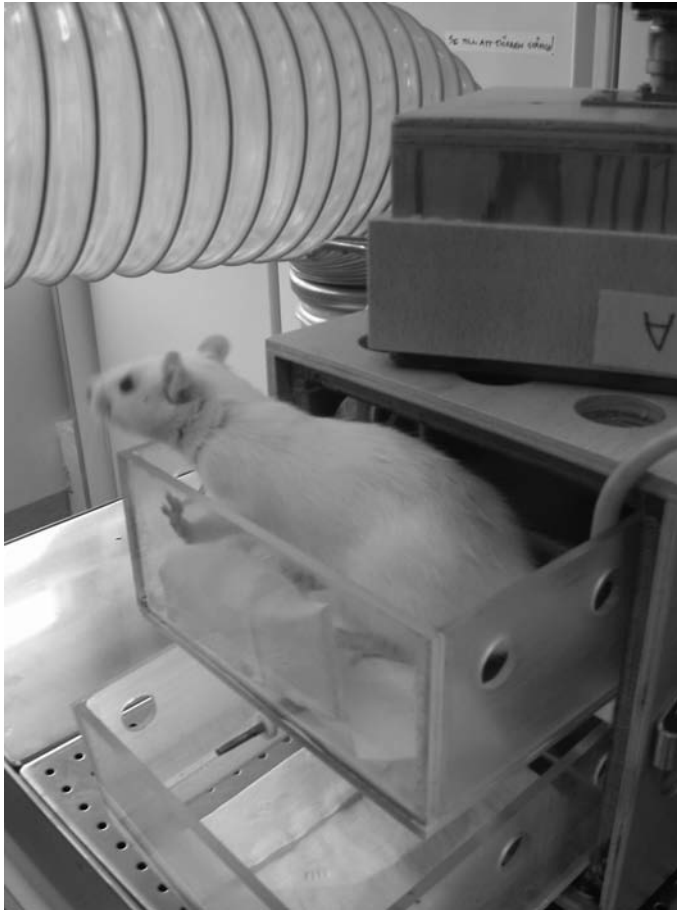

Fig. 2. Rat in the upper compartment of a TEM-cell

energy could affect biological systems, and it was concluded that: “The question is not whether there is a possible mechanism, but rather which of numerous possible mechanisms”³⁵. In order to try to find an answer to that question, the relationship between neural function and behaviour was investigated by Frey *et al.* in 1975. They demonstrated an increased leakage of fluorescein after 30 minutes of pulsed and Continuous Waves (CW) exposure at 1200 MHz³⁵. In general, the fluorescence was seen at the diencephalon level of the brain. Fluorescence was particularly conspicuous in the vicinity of the lateral ventricles and often near the third ventricle. There was a significant difference between the pulsed and continuous waves, and both of these conditions were significantly different from the control condition.

Similar findings were made by Oscar and Hawkins, with 10 minutes of RF exposure at 1300 MHz leading to an increased uptake of D-mannitol in the brains of exposed rats³⁶. The increased permeability was seen both immediately and 4 hours after the exposure, however, not after 24 hours. Notably, MWs of the same average power but with different pulse characteristics produced different uptake levels. Regarding CWs, the uptake of

mannitol increased with increasing power up to 1.0 mW/cm² (corresponding to SAR of 0.4 W/kg), but at higher power densities it started to decrease. For pulsed MWs, a similar phenomenon was seen, but at different power densities. A power window was suggested to explain the fact that increase in the power above certain levels did not result in a corresponding increase of the BBB permeability. Comparing the CWs and pulsed MWs, there were differences in the permeability changes at the same average power. Also, different pulse characteristics of pulsed MWs resulted in different mannitol uptake, although the power density was the same. However, in later studies, Oscar *et al.*³⁷ emphasised that changes of BBB permeability after MW exposure partly could be explained by an increase of local cerebral blood flow. In accordance with this, they concluded that their initial findings³⁶ might be of less magnitude than originally thought³⁷.

Merritt *et al.*³⁸ tried to replicate the findings both by Frey *et al.*³⁵ from 1975 and Oscar and Hawkins³⁶ from 1977. Regarding the findings by Frey *et al.*³⁵, Merritt *et al.*³⁸ could not replicate them in rats exposed to a similar dose of RF radiation at 1,200 MHz, both CW and pulsed. However, Frey commented upon this in an article in 1998, where he pointed out that, in fact, statistical analysis by the editor and reviewer of the data from the study by Merritt *et al.*³⁸ provided a confirmation of the findings of Frey *et al.*³⁵ from 1975³⁹. Regarding the findings by Oscar and Hawkins³⁶, the same lack of replication was reported, as Merritt *et al.*³⁸ found no significant change in the permeability of neither mannitol nor inulin after RF exposure similar to that of Oscar and Hawkins³⁶ from 1977. Similar attempts to replicate the Oscar and Hawkins³⁶ study from 1977 were made by Preston *et al.*, but no increase in the uptake of C-mannitol was found after 30 minutes of exposure to CW MWs at 2450 MHz⁴⁰.

Further lack of EMF induced BBB permeability was reported by Ward *et al.*⁴¹ and by Ward and Ali⁴² for C-sucrose and inulin (CWs exposure during 30 minutes at power densities of 0, 10, 20 and 30 mW/cm²), or by Gruenau *et al.*⁴³ for sucrose (CW and pulsed exposure at 2.8 GHz at power densities between 0 and 40 mW/cm²).

Ward *et al.*⁴¹ found no increased permeation if inulin or sucrose after 2450 MHz irradiation (0-30 mW/cm² for 30 minutes), and with exposure concentrated to the head of the rat⁴² (at 1700 MHz and the same power densities), similar lack of effects were reported. Absence of EMF induced BBB permeability was also reported by Gruenau *et al.*⁴³ (C-sucrose, 30 minutes pulsed or CW radiation at 2.8 GHz between 0-40 mW/cm²).

With horseradish peroxidase (HRP) as an indicator of the BBB permeability, Albert and Kerns⁴⁴ found increases of the tracer in the brains of Chinese hamsters after RF exposure (2 hours CWs at 2450 MHz at 10 mW/cm²). An increased number of pinocytotic vesicles were seen in the endothelial cells of the irradiated animals, but in animals recovering 1 or 2 hours after the RF exposure, almost no horseradish peroxidase permeation could be detected.

Effects of thermal irradiation

With more research into the area of EMF-induced BBB permeability, it became evident that with high-intensity EMF exposure resulting in tissue heating, the BBB permeability is temperature dependent⁴⁵. Thus, the importance of differentiating between thermal and non thermal effects on the integrity of the BBB was realized.

In a series of studies, Williams *et al.*⁴⁵⁻⁴⁸ investigated parameters affecting the BBB passage. Fluorescein was significantly elevated in the brains when rats had been subjected to thermal heating (> 41° C.), corresponding to CW exposure at SAR-levels of

approximately 13.0 W/kg for 30 or 90 minutes. However, the authors believed that these findings were rather due to technical artefacts and not a breakdown of the BBB. Regarding HRP, no HRP leakage could be attributed to MW or thermally-induced breakdown of the BBB (2450 MHz CWs at 0, 20 or 65 mW/cm² for 30, 90 or 180 min)⁴⁷. Regarding sucrose, MW exposure at 2450 MHz for 30 minutes at SAR approximately at 13 W/kg resulted in a decrease of the sucrose uptake, but this decrease was not apparent after 90 minutes⁴⁸.

It was speculated that thermal MW effects could be used to facilitate drug delivery over the BBB. Quock *et al.*⁴⁹ noted that 10 minutes of exposure to 2.45 GHz at 23.7 W/kg facilitated the transport methylatropine, a derivate of atropine. Under non-thermal conditions, the methylatropine does not normally cross the BBB, but after the single thermal MW exposure, anticholinergic effects of methylatropine could be identified (as a shift in the dose-response curves for both pilocarpine and oxotremorine).

Magnetic Resonance Imaging

With the introduction of the magnetic resonance imaging (MRI) technique, combined exposure to RF, pulsed and static magnetic fields was increasingly investigated.

Shivers *et al.* observed that the EMF exposure of the type emitted during a MRI procedure resulted in a temporarily increased permeability in the brains of rats⁵⁰. HRP was used as an exogenous tracer. After 30 minutes of MRI exposure of rats, an amplified vesicle mediated transport could be detected. The vesicles were often attached to the luminal or abluminal cell membrane. These vesicular structures appeared to extend from the luminal to the abluminal cell membrane in some cases, thereby creating transendothelial passageways. Fifteen-thirty minutes after the exposure, the exclusion of protein tracer from subendothelial basal lamina and neuropil was completed. The distribution of the vesicles of the MRI exposed animals was compared to that of sham exposed rats, in which the tracer could be found only in the vascular lumen and luminal sides of the vessels. In neither the MRI or sham exposed rats, the tight junctions of the BBB were permeated with the tracer. This led to the question, whether the RF radiation might modify the physiochemical membrane properties, thereby leading to the increase of vesicle mediated transport. This study was replicated by Garber *et al.*⁵¹, whereas Adzamlı *et al.*⁵² and Preston *et al.*⁵³ could not repeat the findings. The Shivers group later produced quantitative support of their initial findings^{54, 55}. In rats exposed to MRI, the BBB permeability to diethylenetriaminepentaacetic acid (DTPA) increased. A suggested mechanism explaining the increased permeability was a stimulation of endocytosis, made possible through the time-varying magnetic fields.

Research from our laboratory

Stimulated by the work of the London Ontario group, two from our group visited professor Shivers and his colleagues in 1988. LGS in the hope to find an elegant way to open the BBB by the use of controlled EMFs in order to facilitate passage of cytotoxins into the brain, surrounding the tumours of patients with malignant gliomas, BP with the goal to learn more about possible risks of the MRI technology. Thus, our group started work on effects of MRI on rat brain in 1988 and found, by the use of Evans Blue, the same increased permeability over BBB for albumin²⁷.

Our work was continued by separating the constituents of the MRI field: RF, time varying magnetic field and static magnetic field. Since RF turned out to be the most efficient component of the MRI in this aspect, the following studies focused mainly on the RF effects. In order to simulate the actual real-life situation, endogenous substances, which naturally circulate in the vessels of the animals, were used. Albumin and leakage over the BBB was identified with IgG fraction of rabbit anti-rat. All brains were examined histopathologically by our neuropathologist. Regarding albumin extravasation, the number of immunopositive extravasates (foci) were recorded under a microscope. None or occasional minor leakage was rated as normal, whereas one larger or several leakages were regarded as pathological. Immunopositive sites were, however, disregarded when localized in the hypothalamus, above the median eminence and laterally including the lateral hypothalamic nuclei, in the immediate vicinity of the third ventricle and just beneath the pial membrane. These structures are well known for their insufficient BBB. Also the presence and distribution of albumin uptake into neurons was judged semiquantitatively.

We started our RF experiments with the frequency modulation 16 Hz and its harmonics 4, 8, 16 and also 50 Hz, which was felt relevant as it is the standard line frequency of the European power system, with a carrier wave of 915 MHz. At an early stage also 217 Hz modulation was added as this was the frequency of the then planned GSM system. This work was published in 1994²⁹ and 1997²⁶ and comprised sham or 915 MHz exposure for in most cases 2 h but in a minority of the experiments lasting between 2 and 960 min (both continuous and pulsed modulated waves). These results based on 246 rats (1994) and more than 1,000 rats (1997) (the majority EMF exposed and about 1/3 sham-exposed) concluded that there was a significant difference between the albumin extravasation from brain capillaries into the brain tissue between the differently exposed groups and the controls.

It is important to point out that even though all animals in the 1997 series (and basically all of our experiments) are performed in inbred Fischer 344 rats, only at the most 50% of the identically exposed animals display albumin extravasation in CW animals and somewhat less in the other exposed animals. Also the sham-exposed animals have some albumin leakage though only in 17% as a mean of all controls (fig. 3). The leakage observed in unexposed animals presumably is due to our very sensitive immunohistological methods. The peculiar fact that at the most only every second exposed inbred animal displays leakage, is difficult to explain.

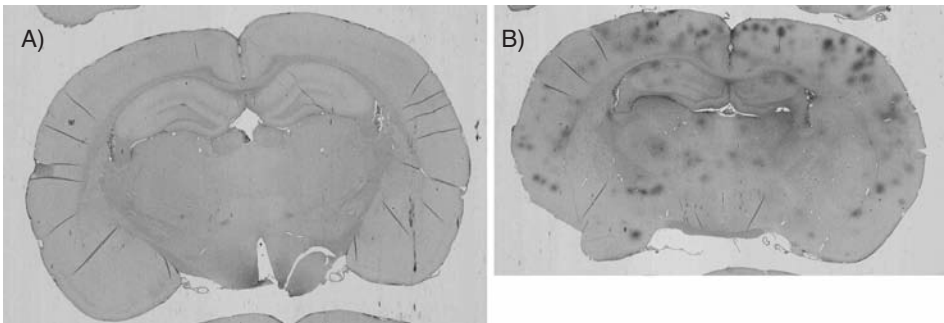

Fig. 3. A) Sham-exposed animal no albumin leakage Notify normal albumin extravasation in Hypothalamus (inbuilt control). B) RF-exposed animal, albumin leakage, Albumin score 3 (on a semi-quantitative score with 3 defined as pronounced albumin leakage and 0 as no albumin leakage)

In a statistical re-evaluation of our material published in 1997²⁶ where only exposed rats with a matched unexposed control rat are included, we found for the most interesting modulation frequency 217 Hz, i.e. that of GSM, that at SAR-values of 0.2 to 4 mW/kg 48 exposed rats had a significantly increased albumin leakage ($p < 0.001$) as compared their 48 matched controls. On the other hand, SAR-values of 25-50 mW/kg, gave no significant difference between 22 exposed rats vs their matched controls (Wilcoxon's Rank Test, 2-sided p-value).

Thus, the most remarkable observation was that exposure with whole-body average power densities below 10 mW/kg gave rise to a more pronounced albumin leakage than higher power densities, all at non-thermal levels. If the reversed situation were at hand, we feel that the risk of cellular telephones, base-stations and other RF emitting sources could be managed by reduction of their emitted energy. The SAR value of around 1 mW/kg exists at a distance of more than 1 m away from the mobile phone antenna and at a distance of about 150–200 m from a base station (figs. 4 and 5).

In all our earlier studies we showed albumin extravasation immediately after exposure as described above. In later years we have performed a series of experiments where the animals were allowed to survive for 7 days⁵⁶, 14 days, 28 days⁵⁷ or 50 days³¹ after one single 2-hour exposure to the radiation from a GSM mobile phone. All were exposed in TEM-cells to a 915 MHz carrier wave as described above. The peak power output from the GSM mobile phone fed into the TEM-cells was 1, 10, 100 and 1000 mW per cell respectively for the 7-14-28-days survival animals, resulting in average whole-body SAR of 0.12, 1.2, 12 and 120 mW/kg for four different exposure groups. The 50-days survival animals were exposed to SAR-values of 1.2, 12 and 120 mW/kg, corresponding to 10, 100 and 1000 mW fed into the TEM-cells.

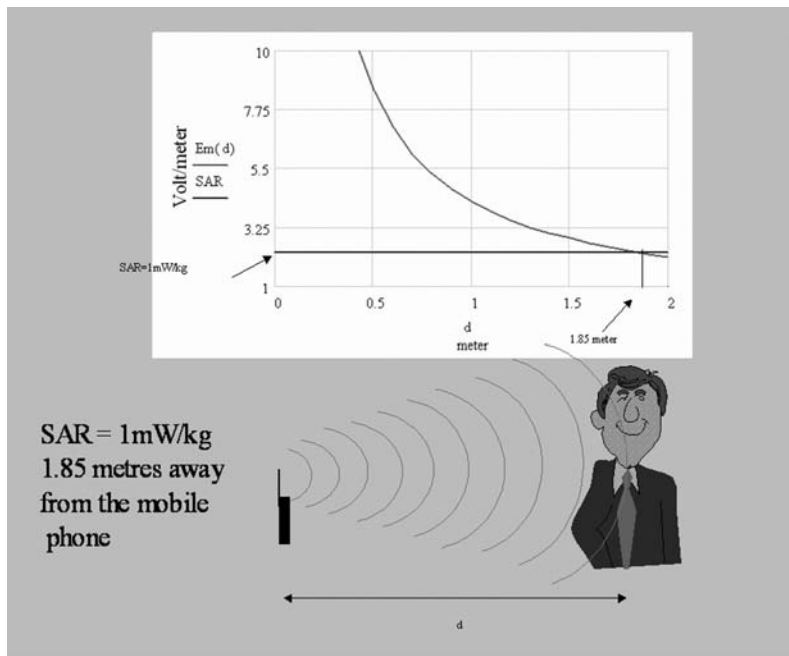

Fig. 4. The SAR-value of around 1 mW/kg exists at a distance of 1.85 meter away from the mobile phone

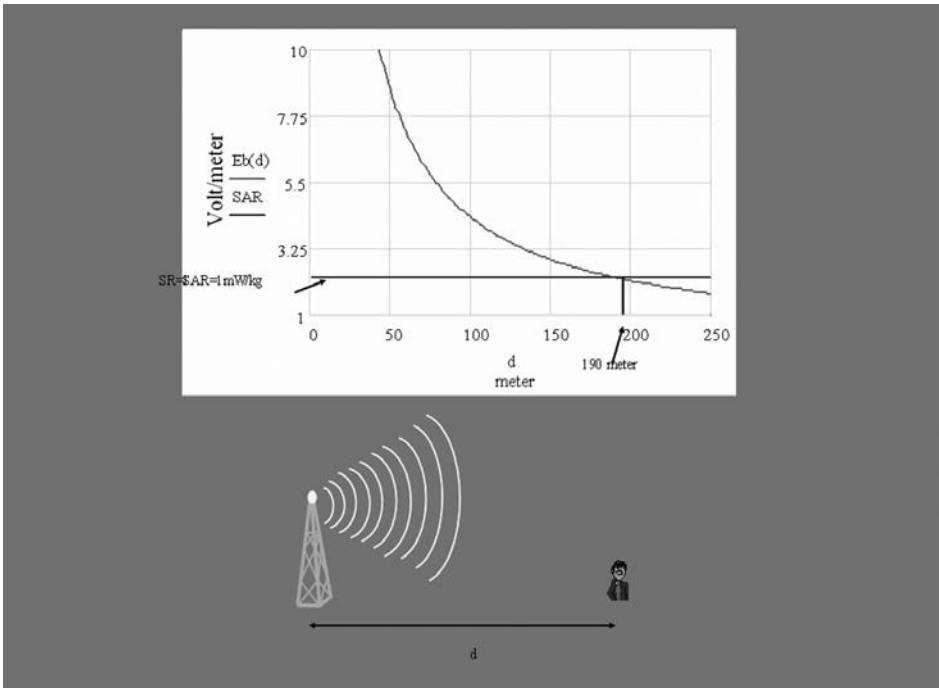

Fig. 5. The SAR-value of 1 mW/kg exists at a distance of 150-200 metres from a base station

Albumin extravasation over the BBB after GSM exposure seemed to be time-dependent, with significantly increased albumin in the brain parenchyma of the rats, which had survived for 7 and 14 days, but not for those surviving 28 days. After 50 days, albumin extravasation was significantly increased again, with albumin-positive foci around the finer blood vessels in white and gray matter of the exposed animals (fig. 6).

In connection to the albumin passage over the BBB, albumin also spread in the surrounding brain tissue. A significantly increased uptake of albumin in the cytoplasm of neurons could be seen in the GSM exposed animals surviving 7 and 14 days after exposure, but not in those surviving 28 or 50 days.

Neuronal uptake

Extravasated albumin rapidly diffused down to, and beyond, concentrations possible to demonstrate accurately immunohistologically. However, the initial albumin leakage into the brain tissue (seen within hours in ~40% of exposed animals in our previous studies) most likely started a vicious circle of further BBB opening.

It has been postulated that albumin is the most likely neurotoxin in serum⁵⁸. Hassel *et al.*⁵⁹ have demonstrated that injection of albumin into the brain parenchyma of rats gives rise to neuronal damage. When 25 μ l of rat albumin is infused into rat neostriatum, 10 and 30, but not 3 mg/ml albumin causes neuronal cell death and axonal severe damage. It also causes leakage of endogenous albumin in and around the area of neuronal

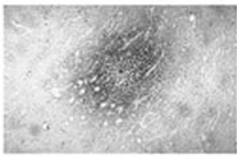
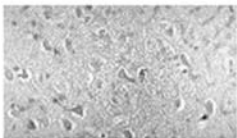
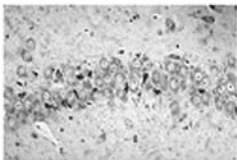
Exposed vs sham		7d	14 d	28 d	50 d
	Albumin foci	0.01	0.02	ns	0.04
	Neuronal albumin	0.03	0.005	ns	ns
	Dark neurons	ns	ns	0.01	0.001

© Salford et al

Fig. 6. Albumin extravasation, neuronal albumin and dark neurons in rats 7, 14, 28 and 50 days after 2 hours of GSM exposure

damage. Albumin in the dose 10 mg/ml is approximately equivalent to 25% of the serum concentration. However, it is less likely that the albumin leakage demonstrated in our experiments locally reaches such concentrations. However, we have seen that in the animals surviving 28 and 50 days after 2 hours of GSM exposure, there was a significantly increased incidence of neuronal damage as compared to the sham controls. In the 7-days and 14-days survival animals, on the other hand, no such increase of neuronal damage was seen.

The damaged neurons took the shape of so-called dark neurons. Three main characteristics of the damaged dark neurons have been proposed⁶⁰: 1) irregular cellular outlines, 2) increased chromatin density in the nucleus and cytoplasm and 3) intensely and homogenously stained nucleus. The damaged dark neurons found in the 50 days-survival animals were investigated regarding signs of apoptotic markers, but we found no positive staining for Caspase-3, a marker for apoptosis⁶¹. However, the albumin leakage out in the neuropil in connection to EMF exposure might start other deleterious processes, leading to the formation of the dark neurons.

In a recent long-term study from our laboratory, rats were exposed to GSM radiation 2 hours weekly during 55 weeks (two different exposure groups with 0.6 mW/kg and 60 mW/kg at the initiation of the exposure period). After this protracted exposure, behaviour and memory of the exposed animals were tested. Whereas the behaviour of the animals was not affected, the GSM exposed rats had significantly impaired episodic memory as compared to the sham controls⁶². After the finalization of these tests, that is 5-7 weeks after the last exposure, the animals were sacrificed by perfusion fixation. Albumin extravasation, an indicator of BBB leakage, was increased in about 1 animal in each group of low GSM exposed, high GSM exposed, sham exposed and cage control

rats. About 40% of the animals had neuronal damage. GFAP staining, as an indicator of glial reaction, revealed positive results in 31-69% of the animals for different groups and the aggregation product lipofuscin was increased in 44-71% of the animals for different groups. With the Gallyas staining (aiming at cytoskeletal structures), no changes were seen. When comparing the results between the different groups, it turned out that there was no statistically significant difference for any of these parameters due to GSM exposure⁶³. When comparing these findings to those from animals which had been exposed only once for 2 hours, it seems likely that during the 55 weeks of repeated exposure, albumin leakage at an initial stage of the experimental period could have been absorbed after some time. At a certain but unknown time point during this protracted, more than 1 year long-exposure period, some adaptation process might have been activated. However, this could not compensate for cognitive alterations.

Other studies of blood-brain barrier permeability including the effects of GSM mobile phones

Since the 1990's, mobile phones have been increasingly used. The RF radiation emitted from these devices was initially of the CW type in NMT mobile phones, but were later almost replaced by the GSM mobile phones with pulsed fields, at frequency levels of 900 MHz (GSM-900) or 1, 800 MHz (GSM-1800), with pulse modulations of 217 Hz.

As mentioned above, in the Lund studies, it has been found that the pulsed fields of the GSM mobile phones increase the permeability of the BBB in exposed rats as compared to sham controls. In order to repeat these findings, studies have been performed by Fritze *et al.*⁶⁴ and Töre *et al.*^{65,66}. Töre *et al.* (Bordeaux) found that 2 hours of GSM-exposure at SAR-values at 0.5 and 2 W/kg increased the BBB permeability, with more pronounced effects seen for exposure at 2 W/kg as compared to 0.5 W/kg. An interesting aspect of this study is the measurement of the blood pressure of the exposed animals, since it is known that the BBB is prone to hypertensive opening. Töre *et al.* found that during the EMF exposure, there was no increase of the blood pressure; it remained within the 100-130 mmHg range. In order to open the BBB through hypertensive mechanisms, it would have been necessary to increase the blood pressure up to 170 mmHg. Another finding in the studies by Töre *et al.* was sympathectomised rats were more sensitive to GSM radiation with a more pronounced increase of the BBB permeability as compared to the non-sympathectomised rats.

In the study by Fritze *et al.*⁶⁴, rats were exposed during 4 hours to GSM-900 MHz radiation with SAR of 0.3, 1.3 and 7.5 W/kg. In the paper published in 1997, Fritze *et al.* reported that there was a significant difference between exposed and sham controls only for the power level of 7.5 W/kg. However, when the Fisher exact probability test was used on the original data, there was a significant difference between the GSM and sham exposed rats also when the 10 animals in each of the power level groups of 0.3 and 1.3 W/kg were pooled ($p=0.01$ Fisher exact probability test)³⁰.

A major concentration of the involved research groups took place at Schloss Reisensburg in Germany in 2003, where the technical approaches in the studies of BBB effects especially were discussed. Two world-renowned researchers in the BBB field, Dr. David Begley of Kings College, London, and Prof. Olaf Poulsen of Copenhagen, Denmark, chaired the FGF/COST 281 Reisensburg, November 2-6 meeting. They made the final statement as a summary of the meeting: "It seems clear that RF fields can have some

effects on tissues''. The statement was made to a large extent on the basis of the concordant findings of the Bordeaux group, represented by Prof. Aubineau, and the Lund group, represented by Prof. Salford and Prof. Persson.

The permeability of the BBB was investigated after exposure to pulsed RF radiation at 2450 MHz for 15, 30, 60 or 120 minutes⁶⁷. Immediately after the exposure, capillary endothelial cells from the cerebral cortex were isolated and with a fluorescein technique, the amount of rhodamine-ferritin complex within these cells was determined. The uptake of rhodamine-ferritin was increased after exposure at an average power density of 10 mW/cm² (corresponding to a SAR-value of 2 W/kg), but not at the power density of 0.5 mW/cm². Also, the duration of exposure influenced the uptake of the substance; with increased uptake after 30, 60 and 120 minutes, but not after 15 minutes. A pinocytotic-like mechanism was proposed to explain the increased uptake after RF exposure⁵⁰. A very interesting finding in this study was that the RF induced rhodamine-ferritin uptake could be blocked by pre-treatment with colchicine. Colchicine inhibits the microtubule function. Thus, it could be seen that RF induced uptake of the systemically administered rhodamine-ferritin by capillary endothelial cells of the cerebral cortex depended both on the power and the duration of the RF exposure, as well as well-functioning microtubules.

In other studies, no EMF induced BBB permeability has been reported⁶⁸⁻⁷¹. Finnie *et al.*⁶⁸ exposed mice to GSM-900 radiation at the SAR-level of 4 W/kg. Albumin immunohistochemistry was used for evaluation. In a second study of BBB permeability, Finnie *et al.*⁶⁹ reported the same lack of GSM EMF induced BBB permeability, in this case after long-term exposure of mice for 104 weeks at SAR-levels of 0.25, 1.0, 2.0 and 4.0 W/kg. Tsurita *et al.*⁷¹ exposed rats to RFs at 1, 439 MHz at SAR-values of 0.25 W/kg. Immunostaining was used to detect albumin extravasation, which however was not increased in this small group of totally 12 EMF exposed animals. Kuribayashi *et al.*⁷⁰ investigated EMF induced BBB permeability in immature and young rats after exposure to 1439 MHz at SAR-levels of 0.2 and 6 W/kg. A dextran tracer was used to evaluate BBB permeability, which was not changed after the exposure. The same group also reported that the immature BBB was insensitive to mobile phone exposure, seen after GSM-900 irradiation of pregnant mice from day 1 to day 19 of gestation (SAR of 4 W/kg, exposure for 60 minutes daily). No increased albumin extravasation was seen in the new-born mice immediately after parturition⁷². Further lack of BBB disruption in young rats, as seen using the Evans blue tracer, was reported by Kumlin *et al.*⁷³ (GSM-900 EMF exposure of young male Wistar rats for 2 hours daily, 5 days weekly for totally 5 weeks at average whole-body SAR of 0.3 and 3 W/kg). However, of the 48 exposed rats, only 12 were examined histopathologically. The remaining animals were included in behavioural tests, where an improvement of learning and memory was seen in a water maze test when comparing the EMF exposed animals to the sham controls. Notably, in all these above mentioned studies with lack of observable EMF induced BBB effects, the SAR-values for exposure are relatively high; never including the low SAR-values in the range of < 10 mW/kg.

Recently, *in vitro* models of the BBB have been used in order to evaluate the EMF induced permeability alterations. Schirmacher *et al.*⁷⁴ used a co-culture consisting of rat astrocytes and porcine brain capillary endothelial cells as a BBB model, including zona occludens proteins, the markers for tight junctions, and with no intercellular clefts. Exposure to GSM-1800 EMFs was found to increase the permeability for sucrose. In a second model, with an improved BBB tightness, the BBB was less sensitive to the EMF exposure, with no increased sucrose passage after GSM-1800 exposure⁷⁵. In a third study

by the same group, the BBB permeability in connection to EMF exposure of the kind emitted by a UMTS mobile phone (3G) was investigated, however, with no findings of increased permeability in connection to the exposure⁷⁶.

Opinions and implications

Mechanisms

Taken together, a large number of studies have been performed within the field of EMF effects upon the mammalian brain. What can be concluded is that the picture of response is highly complex. Whereas some studies show clear effects of increased brain tumour incidence, genetic alterations, EEG changes, altered memory functions and changed neurotransmitter levels; other studies show no significant changes at all. A problem within the field is that the underlying mechanisms are not yet understood. If these had been clearly defined, the possibilities of replicating previous positive findings would have increased significantly. Therefore, the need to define these mechanisms should be obvious. Ways of doing this include both genetic investigations and studies of cell signalling pathways, but also physical and mathematical models are needed in order to clearly define the relationships between EMF radiation and biology.

As described above, in our studies of BBB permeability, we have seen significant biological response at very low SAR levels. This could possibly represent the “inverse U-curve response”, which has also been reported in connection with other kinds of MW exposure previously^{36, 77, 78}. Along these lines, we have specifically studied a Quantum-mechanical model for interaction with protein-bound ions involving Ca²⁺-transport with resonances at certain frequencies⁷⁹. Appropriate combinations of frequency and amplitude affected the Ca²⁺-ion transport systems at various degrees and directions. At fixed values of the static and time varying magnetic fields, resonances were found at certain frequencies (7, 21, 24 and 31 Hz). The interaction of ELF magnetic fields with calcium bound proteins fitted extremely well with the quantum mechanical interaction model described by Blanchard and Blackman⁸⁰ and it was concluded that the resonance could be attributed to 45 Ca²⁺.

In this connection it might be of interest to mention the recent statement that “astrocytic complexity may be the basis for the superior functional competence of the human brain”¹¹. Human protoplasmic astrocytes propagate Ca²⁺ waves with a speed of 35 µm/s, which is fourfold faster than rodent astrocytes. Human astrocytes are larger and structurally more complex than those of rodents¹¹. If EMFs exert their effects, at least to some extent, upon the astrocytes, our experimental findings in spinach vesicles are clearly interesting. It may also give rise to different effects upon the human and the rodent brain.

Other approaches for explaining these effects have been suggested.

The EMF interaction with free ions, where external oscillating fields induce forced vibrations of the ions, leading to increase of intra cellular ion concentration and an osmotically driven entrance of water. This in turn would lead to disruption of plasma membranes⁸¹.

Auto-oxidative processes induced by externally applied MWs. For example, GSM exposure increased the levels of malondialdehyde (MDA), an index for lipid peroxidation, nitric oxide (NO), xanthine oxidase (XO) and adenosine deaminase (ADA) in rats.

These increased were prevented by treatment with anti-oxidant (Ginko Biloba)⁸². Reactive oxygen species also mediated a rapid activation of ERK/MAPKs (mitogenactivated protein kinase) after EMF exposure⁸³. The resulting signalling cascade could ultimately affect transcription, by the central key role of ERKs in signalling pathways. Another signalling pathway activated by MW exposure includes the hsp27/p38MAPK stress signalling pathway, which might lead to stabilisation of endothelial stress fibres⁸⁴.

Alterations of protein conformation of serum albumin, where it has been shown that EMFs can affect the conformation of proteins and thus their biological function. For example, the aggregation of bovine serum albumin is enhanced *in vitro* after exposure to MW radiation at 1.0 GHz and 0.5 W⁸⁵. Both exposure duration and the surrounding temperature influenced the aggregation process. At 60°C amyloid fibril formation of bovine insulin was promoted. Importantly, the alterations of protein conformation were not accompanied by measurable temperature changes. The possibility of protein conformation changes in connection to EMF exposure raises the questions of links to human diseases such as the amyloidopathies (including Creutzfeldt-Jakob disease, Alzheimer's and Parkinson's diseases).

Recently, we described a soliton model, which could be the link between mathematical explanations of EMF interactions and the biological response⁸⁶. A soliton is a non-linear wave. It has been shown that solitons are generated and propagated along the microtubule protofilaments in neurons of the brain⁸⁷. The propagation of solitons in the lipids of biological membranes could play a vital role in the action potential propagation along nerve membranes⁸⁸. Interestingly, the transcription bubble could correspond to a soliton travelling along the DNA chain⁸⁹. The diverse actions of the solitons could be the explanation for the vast number of biological responses, which have been seen throughout the years of studies of EMF effects.

Translation to the human situation

Very few studies on the effects of EMF upon biology include the very low whole-body average power densities that our group works with, e.g. below 10 mW/kg. Our observation that it is SAR values at this level that give rise to the most pronounced albumin leakage, whilst higher power densities, still at non-thermal levels, give less leakage. This is complicated! If the reverse situation were at hand, we feel that the risk of radiation from cellular telephones, base-stations and other RF emitting sources could be managed by reduction of their emitted energy. The SAR value of around 1 mW/kg exists at a distance of more than 1 m away from the mobile phone antenna and at a distance of about 150-200 m from a base station. This also means that when the mobile phone is held next to the ear, the SAR value of about 1 mW/kg exists in the most central portion of the brain (fig. 7), and when a hands-free is used and the phone is e.g. in the pocket, there will still be microwaves reaching the brain, though the value of around 1 mW/kg will exist in more superficial portions of the brain.

A new tool to directly study the human BBB has recently been presented⁹⁰. It provides a non-radioactive methodology for *in vivo* non-invasive, real-time imaging of BBB permeability for conventional drugs, using nitroxyl radicals as spin-labels and MRI. This technology should have a chance to substantially advance our direct knowledge of the human BBB permeability.

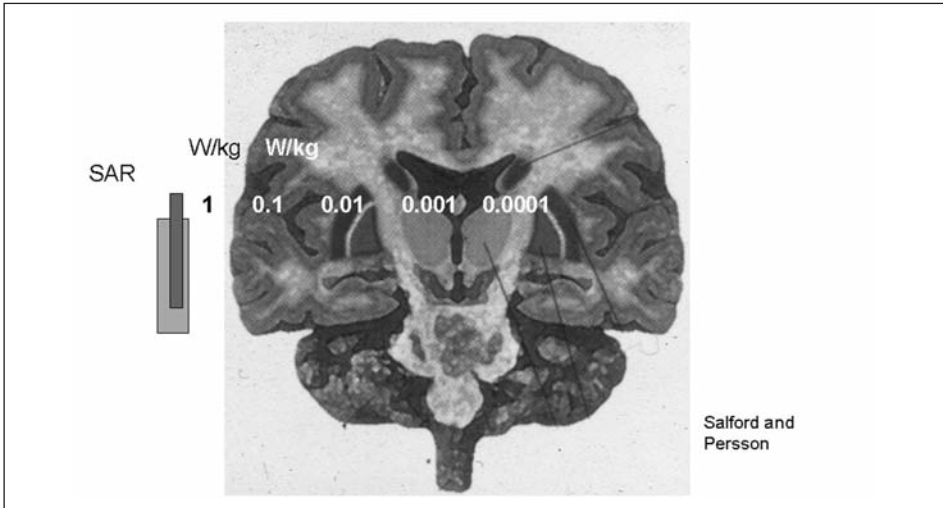

Fig. 7. Mobile phone antenna 1.4 cm from the human head, operating at 915 MHz. The very low SAR-levels of 10 mW/kg exist in deep-lying parts of the human brain such as the basal ganglia, and the power density of 1 mW/kg is absorbed in thalamus

Non-thermal vs thermal effects

These non-thermal effects are very important to clarify, considering that the exposure limits set up today mainly focus on preventing thermal effects. In many safety standard documents, a SAR-limit of 4 W/kg is referred to localized SAR of limbs and 2 W/kg for localized SAR of head and trunk²⁴. The reason for choosing this SAR-value is a series of studies performed by deLorge and co-workers in the 1970's and early 1980's. In these studies, the trained behavioural performance of rats, squirrel monkeys and rhesus monkeys was tested after MW exposure. It was found that body temperature increases of 1°C or more above the baseline body temperature resulted in changes of this kind of behaviour in the animals. Notably, a SAR of near 4 W/kg was needed to produce this 1°C increase of body temperature^{91, 92}.

These safety limits for thermal exposure are inadequate for all the described non-thermal effects! New standards are required for the non-thermal effects.

Positive vs negative effects

In a situation where series of studies show significant effects of radiation and other studies have failed to show effects, it is important to remember, that the demonstrated effects cannot be disregarded because other studies have shown no effects. According to the Rio declaration, the precautionary principle has to be followed. Where there are threats of serious or irreversible damage, lack of full scientific certainty shall not be used as a reason for postponing effective measures to prevent damage. Thus precautionary measures are needed, including, not least, extensive future research within this field.

Conclusion

Having personally demonstrated a long series of significant effects of RF-EMF in our animal models, it is our sincere belief, that it is more probable than unlikely, that non-thermal electromagnetic fields from mobile phones and base stations do have effects upon the human brain.

In this context it should, however, be remembered that recently, observations on differences between astrocytic endfeet in the human and the rodent BBB have been published¹¹. More research in this field is important for the translation of results from animal studies to the human situation.

If mobile communication, even at extremely low SAR values, causes the users' own albumin to pass the BBB, which is meant to protect the brain, also other unwanted and toxic molecules in the blood, may pass into the brain tissue and concentrate in and damage the neurons and glial cells of the brain.

The intense use of mobile phones, not least by youngsters, is a serious memento. A neuronal damage may not have immediately demonstrable consequences, even if repeated. It may, however, in the long run, result in reduced brain reserve capacity that might be unveiled by other later neuronal disease or even the wear and tear of ageing. We can not exclude that after some decades of (often), daily use, a whole generation of users, may suffer negative effects such as autoimmune and neuro-degenerative diseases maybe already in their middle age.

We conclude that the suppliers of mobile communication - and our politicians - have an extensive responsibility to support the exploration of these possible risks for the users and the society.

Acknowledgements

This work has been supported by the Hans and Märít Rausing Charitable Foundation, the Swedish Council for Working-life and Social Research and the Lund University Hospital Research Funds.

References

1. Carlsson SD, Juang JL, Hilgers LS, *et al.* Blood barriers of the insect. *Annu Rev Entomol* 2000; 45: 11-74.
2. Abbott NJ, Pichon Y. The glial blood-brain barrier of crustacea and cephalopods: a review. *J Physiol (Paris)* 1987; 82: 304-13.
3. Gotow T, Hashimoto PH. Plasma membrane organization of astrocytes in elasmobranchs with special reference to the brain barrier system. *J Neurocytol* 1984; 13: 727-42.
4. Reinecke M. The glial cells of the cerebral ganglia of *Helix pomatia* L. (Gastropoda, Pulmonata) II. Uptake of ferritin and 3H-glutamate. *Cell Tissue Res* 1976; 169: 361-82.
5. Alberts B, Johnson A, Lewis J, *et al.* Cell junctions, cell adhesion and the extracellular matrix. In Gibbs S, ed. *Molecular Biology of the Cell*, chapter 19. Garland Publishing, 2002.
6. Frank RN, Dutta S, Mancini MA. Pericyte coverage is greater in the retinal than in the cerebral capillaries of the rat. *Invest. Ophthalmol Vis Sci* 1987; 28: 1086-91.
7. Thomas WE. Brain macrophages: on the role of pericytes and perivascular cells. *Brain Res Rev* 1999; 31: 42-57.
8. Ghersi-Egea JF, Minn A, Siest G. A new aspect of the protective functions of the BBB: activities of four drug-metabolizing enzymes in isolated rat brain microvessels. *Life Sci* 1988; 42: 2515-23.
9. De Vries HE, Kuiper J, De Boer AG, *et al.* The blood-brain barrier in neuroinflammatory diseases. *Pharmacol Rev* 1997; 49: 143-55.

10. Oberheim NA, Wang X, Goldman S, *et al.* Astrocytic complexity distinguishes the human brain. *Trends Neurosci* 2006; 29: 547-53
11. Oberheim NA, Takano T, Han X, *et al.* Uniquely hominid features of adult human astrocytes. *J Neurosci* 2009; 29: 3276-87.
12. Banks WA, Kumar VB, Franko MW, *et al.* Evidence that the species barrier of human immunodeficiency virus-1 does not extend to uptake by the blood-brain barrier: comparison of mouse and human brain microvessels. *Life Sci* 2005; 77: 2361-8.
13. Hsiao P, Sasongko L, Link JM, *et al.* Verapamil P-glycoprotein transport across the rat blood-brain barrier: cyclosporine, a concentration inhibition analysis, and comparison with human data. *J Pharmacol Exp Ther* 2006; 317: 704-10.
14. Gerhart DZ, Leino RL, Borson ND, *et al.* Localization of glucose transporter GLUT 3 in brain: comparison of rodent and dog using species-specific carboxyl-terminal antisera. *Neurosci* 1995; 66: 237-46
15. Oldendorf WH, Cornford ME, Brown WJ. The large apparent work capability of the BBB: a study of the mitochondrial content of capillary endothelial cells in brain and other tissues of the rat. *Ann Neurol* 1977; 1: 409-17.
16. Mihály A, Bozöky B. Immunohistochemical localization of serum proteins in the hippocampus of human subjects with partial and generalized epilepsy and epileptiform convulsions. *Acta Neuropathol* 1984a; 127: 251-67
17. Mihály A, Bozöky B. Immunohistochemical localization of extravasated serum albumin in the hippocampus of human subjects with partial and generalized and epileptiform convulsions. *Acta Neuropathol* 1984b; 65: 471-7.
18. Sokrab TEO, Johansson BB, Kalimo H, *et al.* A transient hypertensive opening of the blood-brain barrier can lead to brain damage. *Acta Neuropathol* 1988; 75: 557-65.
19. Hardebo JE. A time study in rat on the opening and reclosure of the blood-brain barrier after hypertensive or hypertonic insult. *Exp Neurol* 1980; 70: 155-66.
20. Hardebo JE, Nilsson B. Hemodynamic changes in brain caused by local infusion of hyperosmolar solutions, in particular relation to blood-brain barrier opening. *Brain Res* 1980; 181: 49-59.
21. Lane NJ, Harrison JB, Bowerman RF. A vertebrate-like blood-brain barrier, with intraganglionic blood channels and occluding junctions, in the scorpion. *Tissue Cell* 1981; 13: 557-76.
22. Abbott NJ, Bundgaard M. Electron-dense tracer evidence for a blood-brain barrier in the cuttlefish *Sepia officinalis*. *J Neurocytol* 1992; 21: 276-94.
23. Dziegielewska KM, Hagbood M, Jones SE, *et al.* Proteins in cerebrospinal fluid and plasma of postnatal *Monodelphis domestica*. *Comp Biochem Physiol* 1989; 92: 569-76.
24. ICNIRP Guidelines for limiting exposure to time-varying electric, magnetic and electromagnetic fields (up to 300 GHz). *Health Phys* 1998; 74: 494-522.
25. Martens L, Van Hese J, De Sutter D, *et al.* Electromagnetic field calculations used for exposure experiments on small animals in TEM-cells. *Bioelectrochem Bioenerg* 1993; 30: 73-81.
26. Persson BRR, Salford LG, Brun A. Blood-brain barrier permeability in rats exposed to electromagnetic fields used in wireless communication. *Wireless Networks* 1997; 3: 455-61.
27. Salford LG, Brun A, Eberhardt J, *et al.* Electromagnetic field-induced permeability of the blood-brain barrier shown by immunohistochemical methods. In Norden B, Rame C, eds. *Interaction mechanism of low-level electromagnetic fields*. Living Systems Oxford, Oxford University Press, 1992; 251-8.
28. Salford LG, Brun A, Eberhardt JL, *et al.* Permeability of the blood-brain-barrier induced by 915 MHz electromagnetic-radiation, continuous wave and modulated at 8, 16, 50 and 200 Hz. *Bioelectrochem Bioenerg* 1993; 30: 293-301.
29. Salford LG, Brun A, Stureson K, *et al.* Permeability of the blood-brain-barrier induced by 915 MHz electromagnetic-radiation, continuous wave and modulated at 8, 16, 50 and 200 Hz. *Microsc Res Tech* 1994; 27: 535-42.
30. Salford LG, Persson B, Malmgren L, *et al.* Téléphonie Mobile et Barrière Sang-Cerveau. In Pietteur M, ed. *Téléphonie mobile – effets potentiels sur la santé des ondes électromagnétiques de haute fréquence*. Belgium, Emburg, 2001; 141-52.
31. Salford LG, Brun AE, Eberhardt JL, *et al.* Nerve cell damage in mammalian brain after exposure to microwaves from GSM mobile phones. *Environ Health Perspect* 2003; 111: 881-3.
32. Van Hese J, Martens L, De Zutter D, *et al.* Simulation of the effects of inhomogeneities in TEM transmission cells using the FDTD-method. *IEEE Trans Electromang Compat* 1992; 34: 292-8.

33. Malmgren L. Radio frequency systems for NMR imaging: coil development and studies of non-thermal biological effects (PhD thesis). Lund, Sweden. Department of Applied Electronics, Lund University, 1998.
34. Stagg RB, Havel LH III, Pastorian K, *et al.* Effect of immobilization and concurrent exposure to a pulse-modulated microwave field on core body temperature, plasma ACTH and corticosteroid, and brain ornithine decarboxylase, Fos and Jun mRNA. *Radiat Res* 2001; 155: 584-92.
35. Frey AH, Feld SR, Frey B. Neural function and behaviour: defining the relationship. *Ann NY Acad Sci* 1975; 247: 433-9.
36. Oscar KJ, Hawkins TD. Microwave alteration of the BBB system of rats. *Brain Res* 1977; 126: 281-93.
37. Oscar KJ, Gruenau SP, Folker MI, *et al.* Local cerebral blood flow after microwave exposure. *Brain Res* 1982; 204: 220-5.
38. Merritt JH, Chamness AF, Allen SJ. Studies on BBB permeability. *Radial Environ Biophys* 1978; 15: 367-77.
39. Frey AH. Headaches from cellular phones: are they real and what are the implications? *Environ Health Perspect* 1998; 106: 101-3.
40. Preston E, Vavasour RJ, Assenheim HM. Permeability of the BBB to mannitol in the rat following 2450MHz microwave irradiation. *Brain Res* 1979; 174: 109-17.
41. Ward TR, Elder JA, Long MD, *et al.* Measurement of BBB permeation in rats during exposure to 2450-MHz microwaves. *Bioelectromagnetics* 1982; 3: 371-83.
42. Ward TR, Ali JS. BBB permeation in the rat during exposure to low-power 1.7-GHz microwave radiation. *Bioelectromagnetics* 1985; 6: 131-43.
43. Gruenau SP, Oscar KJ, Folker MT, *et al.* Absence of microwave effect on blood-brain-barrier permeability to [C-14]-labeled sucrose in the conscious rat. *Exp Neurol* 1982; 75: 299-307.
44. Albert EN, Kerns JM. Reversible microwave effects on the BBB. *Brain Res* 1981; 230: 153-64.
45. Williams WM, Lu ST, del Cerro M, *et al.* Effect of 2450MHz microwave energy on the BBB to hydrophilic molecules. D. Brain temperature and BBB permeability to hydrophilic tracers. *Brain Res* 1984d; 319: 191-212.
46. Williams WM, Hoss W, Formaniak M, *et al.* Effects of 2450MHz microwave energy on the BBB to hydrophilic molecules. A. Effect on the permeability to sodium fluorescein. *Brain Res Rev* 1984a; 7: 165-70.
47. Williams WM, del Cerro M, del Michaelson SM. Effects of 2450MHz microwave energy on the BBB to hydrophilic molecules. B. Effects on the permeability to HRP. *Brain Res Rev* 1984b; 7: 171-81.
48. Williams WM, Platner J, del Michaelson SM. Effects of 2450MHz microwave energy on the BBB to hydrophilic molecules. C. Effects on the permeability to [14C]sucrose. *Brain Res Rev* 1984c; 7: 183-90.
49. Quock RM, Fujimoto JM, Koryo Ishi T, *et al.* Microwave facilitation of methylatropine antagonism of central cholinomimetic drug effects. *Radiat Res* 1986; 105: 328-40.
50. Shivers RR, Kavaliers M, Teskey GC, *et al.* Magnetic resonance imaging temporarily alters blood-brain barrier permeability in the rat. *Neurosci Lett* 1987; 76: 25-31.
51. Garber HJ, Oldendorf WH, Braun LD, *et al.* MRI gradient fields increase brain mannitol space. *Magn Reson Imaging* 1989; 7: 605-10.
52. Adzamlı IK, Jolesz EA, Blau M. An assessment of BBB integrity under MRI conditions: brain uptake of radiolabelled Gd-DTPA and In-DTPA-IgG. *J Nucl Med* 1989; 30: 839-40.
53. Preston E, Buffler K, Haas N. Does magnetic resonance imaging compromise integrity of the BBB? *Neurosci Lett* 1989; 101: 46-50.
54. Prato FS, Frappier RH, Shivers RR, *et al.* Magnetic resonance imaging increases the blood-brain barrier permeability to 153-gadolinium diethylenetriaminepentaacetic acid in rats. *Brain Res* 1990; 523: 301-4.
55. Prato FS, Wills JM, Roger J, *et al.* BBB permeability in rats is altered by exposure to magnetic fields associated with magnetic resonance imaging at 1.5 T. *Microsc Res Tech* 1994; 27: 528-34.
56. Nitty H, Brun A, Eberhardt J, *et al.* Increased blood-brain barrier permeability in the mammalian brain seven days after exposure to the radiation from a GSM-900 mobile phone. *Pathophysiol* in press, available online. 2009.
57. Eberhardt JL, Grafström G, Malmgren L, *et al.* Blood-brain barrier permeability and nerve cell damage in the rat brain 14 and 28 days after exposure to microwaves from GM mobile phones. *Electromagn Biol Med* 2008; 27: 215-29

58. Eimerl S, Schramm M. Acute glutamate toxicity and its potentiation by serum albumin are determined by the Ca²⁺ concentration. *Neurosci Lett* 1991; 130: 125-7.
59. Hassel B, Iversen EG, Fonnum F. Neurotoxicity of albumin in vivo. *Neurosci Lett* 1994; 167: 29-32.
60. Sugimoto T, Bennett GJ, Kajander KC. Transsynaptic degeneration in the superficial dorsal horn after sciatic nerve injury: effects of a chronic constriction injury, transaction and strychnine. *Pain* 1990; 42: 205-13.
61. Bexell D. No neuronal apoptosis after EMF microwave exposure from mobile phones. Personal communication. Dissertation work for medical degree with Leif G. Salford as supervisor.
62. Nittby H, Grafström G, Tian D, *et al.* Cognitive impairment in rats after long-term exposure to GSM-900 mobile phone radiation. *Bioelectromagnetics* 2008; 29: 219-32.
63. Grafström G, Nittby H, Brun A, *et al.* Histopathological examinations of rat brains after long-term exposure to GSM-900 mobile phone radiation. *Brain Res Bull* 2008; 77: 257-63.
64. Fritze K, Sommer C, Schmitz B, *et al.* Effect of global system for mobile communication (GSM) microwave exposure on blood-brain barrier permeability in rat. *Acta Neuropathol* 1997; 94: 465-70.
65. Töre F, Dulou PE, Haro E, *et al.* Two-hour exposure to 2-W/kg, 900-MHZ GSM microwaves induces plasma protein extravasation in rat brain and dura mater. In Proceedings of the 5th International congress of the EBEEA. Helsinki, Finland, 2001; 43-5.
66. Töre F, Dulou PE, Haro E, *et al.* Effect of 2 h GSM-900 microwave exposures at 2.0, 0.5 and 0.12 W/kg on plasma protein extravasation in rat brain and dura mater. In Proceedings of the 24th annual meeting of the BEMS, 2002; 61-2.
67. Neubauer C, Phelan AM, Kues H, *et al.* Microwave irradiation of rats at 2.45 GHz activates pinocytotic-like uptake of tracer by capillary endothelial cells of cerebral cortex. *Bioelectromagnetics* 1990; 11: 261-8.
68. Finnie JW, Blumbergs PC, Manavis J, *et al.* Effect of global system for mobile communication (GSM)-like radiofrequency fields on vascular permeability in mouse brain. *Pathology* 2001; 33: 338-40.
69. Finnie JW, Blumbergs PC, Manavis J, *et al.* Effect of long-term mobile communication microwave exposure on vascular permeability in mouse brain. *Pathology* 2002; 34: 244-347.
70. Kuribayashi M, Wang J, Fujiwara O, *et al.* Lack of effects of 1439 MHz electromagnetic near field exposure on the BBB in immature and young rats. *Bioelectromagnetics* 2005; 26: 578-88.
71. Tsurita G, Nagawa H, Ueni S, *et al.* Biological and morphological effects on the brain after exposure of rats to a 1439 MHz TDMA field. *Bioelectromagnetics* 2000; 21: 364-71.
72. Finnie JW, Blumbergs PC, Cai J, *et al.* Effect of mobile telephony on blood-brain barrier permeability in the fetal mouse brain. *Pathology* 2006; 38: 63-5.
73. Kumlin T, Livonen H, Miettinen P, *et al.* Mobile phone radiation and the developing brain: behavioral and morphological effects in juvenile rats. *Radiat Res* 2007; 168: 471-9.
74. Schirmacher A, Winters S, Fischer S, *et al.* Electromagnetic fields (1.8 GHz) increase the permeability to sucrose of the BBB in vitro. *Bioelectromagnetics* 2000; 21: 338-45.
75. Franke H, Ringelstein EB, Stögbauer F. Electromagnetic fields (GSM1800) do not alter BBB permeability to sucrose in models in vitro with high barrier tightness. *Bioelectromagnetics* 2005a; 26: 529-35.
76. Franke H, Streckert J, Bitz A, *et al.* Effects of universal mobile telecommunications system (UMTS) electromagnetic fields on the BBB in vitro. *Radiat Res* 2005b; 164: 258-69.
77. Adey WR. Frequency and power windowing in tissue interactions with weak electromagnetic fields. *Proc IEEE* 1980; 68: 119-25.
78. Markov M. Biological windows: a tribute to W. Ross Adey. *The Environmentalist* 2005; 25: 67-74.
79. Bauréus Koch CLM, Sommarin M, Persson BRR, *et al.* Interaction between weak low frequency magnetic fields and cell membranes. *Bioelectromagnetics* 2003; 24: 395-402.
80. Blanchard JP, Blackman CF. Clarification and application of an ion parametric resonance model for magnetic field interactions with biological systems. *Bioelectromagnetics* 1994; 15: 217-38.
81. Panagopoulos DJ, Margaritis LH. Mobile telephony radiation effects on living organisms. In Harper AC, Buress RV, eds. *Mobile telephones*. Nova Science Publishers Inc, 2008; 107-49.
82. Ilhan A, Gurel A, Armutcu F, *et al.* Ginkgo biloba prevents mobile phone-induced oxidative stress in rat brain. *Clin Chim Acta* 2004; 340: 153-62.

83. Friedman J, Kraus S, Hauptman Y, *et al.* Mechanism of a short-term ERK activation by electromagnetic fields at mobile phone frequency. *Biochem J* 2007; 405: 559-68
84. Leszczynski D, Joenvaara S, Reivinen J, *et al.* Non-thermal activation of the hsp27/ p38MAPK stress pathway by mobile phone radiation in human endothelial cells: molecular mechanisms for cancer- and BBB-related effects. *Differentiation* 2002; 70: 120-9.
85. De Pomerai DI, Smith B, Dawe A, *et al.* Microwave radiation can alter protein conformation without bulk heating. *FEBS Lett* 2003; 543: 93-7.
86. Salford LG, Nittby H, Brun A, *et al.* The mammalian brain in the electromagnetic fields designed by man-with special reference to blood-brain barrier function, neuronal damage and possible physical mechanisms. *Progress of Theoretical Physics suppl* 2008; 173: 283-309.
87. Abdalla E, Maroufi B, Melgar BC, *et al.* Information transport by sine-Gordon solitons in microtubules. *Physica A* 2001; 301:169-72.
88. Heimburg T, Jackson AD. On soliton propagation in biomembranes and nerves. *Proc Natl Acad Sci USA* 2005; 102: 9790-5.
89. Gaeta G. Results and limitations of the soliton theory of DAN transcription. *J Biol Phys* 1999; 24: 81-96.
90. Zhelev Z, Bakalova R, Aoki I, *et al.* Nitroxyl radicals as low toxic spin-labels for non-invasive magnetic resonance imaging of blood-brain barrier permeability for conventional therapeutics. *Chem Commun* 2009; 1: 53-5.
91. deLorge JO. Operant behavior and colonic temperature of *Macaca mulatta* exposed to radio frequency fields at and above resonant frequencies. *Bioelectromagnetics* 1984; 5: 233-46.
92. D'Andrea JA. Behavioural evaluation of microwave irradiation. *Bioelectromagnetics* 1999; 20: 64-7.

Carcinogenic risks in workers exposed to radiofrequency and microwave radiation

Stanislaw Szmigielski*, **

* Department of Microwave Safety, Military Institute of Hygiene and Epidemiology, Warsaw, Poland

** Mazovian Academy, Warsaw, Poland

Abstract

Microwave (MW) radiation, part of the electromagnetic spectrum at wave frequencies of 300 MHz – 300 GHz, can penetrate human tissues and exert various bioeffects at relatively low field power densities. Experimental investigations revealed the possibility of epigenetic activity of certain MW exposures (frequently limited to particular frequencies and/or modulations of the carrier wave), but there exists no satisfactory support from epidemiological studies for the increased cancer risk in MW-exposed subjects. Use of mobile phones (MP) considerably increased local exposure to 900 or 1800 MHz and raised concerns of the risk of brain tumors and other neoplasms of the head. At present the experimental and epidemiological bulk of evidence is too limited for valid assessment of the risks. Two available epidemiological studies of brain cancer morbidity in MP users did not confirm an increased risk for all types of neoplasms, but unexplained excesses of particular types and/or locations of the tumors has been reported. However, there exist single epidemiological studies which indicate increased mortality of certain types of neoplasms in workers exposed to microwave radiation. As an example, the multiyear study of cancer morbidity in Polish military personnel exposed to 2-10 W/m² will be presented. Despite of the reported increased morbidity of haematopoietic and lymphatic neoplasms, it was not possible to confirm the causal link of the morbidity with exposure to MW radiation. Therefore, it is concluded that the epidemiologic evidences still falls short of their strength and consistency required to come to a reasonable conclusion that MW can cause human cancer and thus, this radiation should be classified in group 3 (unclassifiable as to carcinogenicity in humans) of the IARC classification of human carcinogens.

Key words: microwave radiation, carcinogenic risk, haematopoietic neoplasms, brain tumours, workers exposed, epidemiological study

Introduction

Electromagnetic fields have been linked with increased risk of neoplastic diseases for a long time, but the available experimental and medical data still did not allow for valid

Address: Prof. dr med. Stanislaw Szmigielski, Department of Microwave Safety, Military Institute of Hygiene and Epidemiology, Kozielska str.4, PL-01-163 Warsaw, Poland
E-mail: szmigielski@wihe.waw.pl

conclusions. There exists a fragmentary and scarce support from experimental studies which indicates a possibility of epigenetic (non-genotoxic) potency of microwave energy in the multistep process of carcinogenesis¹, although possible mechanisms underlying these phenomena still remain hypothetical. A detail analysis of this problem is presented in the IEGMP-2000 Report².

Our knowledge on cancer morbidity in workers and lay people exposed to microwaves (MWs) is based mostly on results of retrospective epidemiological studies, as experiments on cells and animals did not provide confirming data on increased risks of cancer².

Fortunately, a comprehensive evaluation of residential exposure to RF and MW indicates that, in general, the exposure levels are relatively low². Measurements performed in 15 large cities in the USA revealed that the median exposure level ranged about 0.05 W/m², with 90% of residents being exposed to fields not exceeding 0.1 W/m². Only approximately 1% of the population studied was potentially exposed to levels greater than 0.1 W/m². These higher exposures occur at limited areas located close to strong MW sources. Such situations can exist e.g. in proximity to very powerful, ground-level transmitters, or to low-power, in-town repeaters, which are typically mounted on the top of tall buildings.

Introduction of cellular phone (CP) systems and a fast increase of number of users of hand-held phones in the last decade has changed the MF exposure levels of the population quite considerably. With CPs, a MW transmitter has been for the first time ever in history put right up against the side of anyone's head, and switched on. Analysis of distribution and absorption of the radiation revealed that about 40% of the MW energy emitted from CP antenna goes into the user's head and hands². Such situation raised immediately concerns about possible health risks of the exposures, including risk of developing cancer, both among the bioelectromagnetic community and the public. Cancer risks related to exposure to radiation from base stations and terminals (cell phones) are described in another chapter of this monograph. Therefore, this problem will not be discussed here.

The epidemiological studies on environmental exposures completed so far have mostly looked at cancer incidence in residents living close to radio and television transmitters and gave controversial results, although in summary did not find a sufficient evidence for an increased risk. Following a study of residents living around one TV and radio broadcasting tower in UK in which a significant increase in morbidity from adult leukaemia was reported in people residing within 2 km of the transmitter³, a more comprehensive study, performed by the same authors around 20 transmission towers in UK, did not confirm this finding⁴. The study, based on 79 cases of adult leukemia revealed that for persons residing within 2 km from the transmitters the morbidity ratio was not increased (observed/expected O/E = 0.97), however a small, but significant, decline in risk of adult leukemia with distance from transmitters in the 2-10 km. was found^{3,4}. Similar observations were made in Australia. A study of cancer incidence among residents living in the "inner" (close to TV towers) and "outer" (more distant) municipalities in Northern Sydney reported an increased morbidity and mortality of childhood leukaemia⁵ in the "inner" municipalities. However, when these data were reanalyzed and other "inner" municipalities were added⁶, it appeared that the excess of childhood leukaemia was restricted only to one (of six) "inner" municipalities and there exist no evidences for linking it with the low-level MW exposures. In more recent publications^{7,8,9} data supporting increased risk of cancer in children and adults living close to radio and/or TV transmitters were reported, but in other studies^{10,11} no such phenomena have been

found. In view of the above publications it may be concluded that the problem of increased cancer risks from environmental RF/MW exposures still remains open but the bulk of evidence supporting such hypothesis is large enough to call for further studies.

Epidemiological observations of occupational groups which are exposed to MWs at work^{12,13,14,15} also do not provide sufficient evidence for a causal links between exposure and increased risk of neoplastic diseases, although in some studies a considerably higher morbidity rates were reported (for reviews, see^{14,16,17}). It should be also pointed that each work environment has an individual combination of physical, chemical and psychosocial factors which may influence human physiology, including development of neoplastic diseases, in a very specific and unique way^{13,16}. Therefore, the results of occupational studies of MW-exposed workers cannot be directly extrapolated as health risks for the general public, the more that intensities and time sequences of MW exposures in workers and in the environment are different¹⁶. A typical MW intensities at work range from 2 - 10 W/m² with incidental exposures at 10 - 30 W/m² and a period of exposure being limited to 1-2 hr during a working shift¹⁴, while in the environment and homes MW fields normally do not exceed 0.1 W/m², but the exposure tends to be continuous.

Overview of own studies

There exist single reports, published in peer-reviewed scientific journals, which indicate that occupational exposures to radiofrequency (RF) and microwave (MW) radiations may be associated with significantly increased risks for cancer, notably hematolymphatic and brain, in electronic, radar and radio communication workers^{13,14,15,17}.

Some time ago the results of our retrospective analysis of cancer morbidity for the whole population of career military personnel in Poland during the decade of 1970 - 1979 was published¹⁴, although at that time the exact size of the population could not be revealed. Therefore, the results and their discussion were limited to mortality rates (number of newly diagnosed cancer cases per 100,000 of subjects per year). Nevertheless, a significantly higher rate of particular types of neoplasms (hematologic, lymphatic system, skin tumours, alimentary tract cancers) in personnel exposed occupationally to RFs and MWs¹⁴ encouraged us to continue the prospective analysis of morbidity and extend the observation period for the years 1980 - 1985. In 1996 the joint analysis covering the 15- year period of 1971 - 1985 has been published¹⁴. It has been found that the subpopulation of about 3-4% which had a documented occupational exposure to RF/MW radiation developed about 9% of all malignancies, giving the OER (Observed/Exposed Ratio) of 2.1 - 3.1, depending on year of analysis. This difference in cancer morbidity related only to particular types of malignancies and still more, the retrospective analysis did not allow for precise assessment of past RF/MW exposure intensity (doses). Therefore, at that time the search for possible relations between cancer morbidity (risks) and levels of the RF/MW exposure was not possible. Additionally, we were aware that the analysis was based on generally low number of registered cases of neoplasms and both increasing size of the RF/MW-exposed population and longer period of observation has been postulated, before final conclusions can be obtained.

In 1985 a prospective analysis of cancer morbidity in Polish military career personnel has been started and additionally, the exposure levels of the personnel were measured. It has been found that RF/MW exposure of the investigated population (about 4000 of the career servicemen) is variable, depending on type of work; the majority of workers

(about 85%) were exposed to mean power densities not exceeding at work posts the value of 6 W/m², whereas only about 15% of servicemen were exposed to power densities above 6 W/m² (Table 1).

In the later published study of cancer morbidity in Polish military personnel exposed to RF/MW radiation¹⁵ we reported a coherent mean exposure levels (expressed in W/m²) (Table 2).

On base of these data we conclude that workers exposed to mean power densities exceeding 6 W/m² may be considered as those being at higher risk of developing certain

Table 1 - Cancer morbidity in Polish career military personnel exposed occupationally to RF and MW radiation - a 5- year analysis (1985 - 1990). Exposure levels and morbidity rate in prospective study (1985 - 1990)

Year of analysis	Percent of career personnel considered as exposed to RF/MW	Average exposure levels (W/m ²) for 2 - 4 hours during working shift (% of personnel with exposure)			
		1 - 2	2 - 6	6 - 10	> 10
Occupational exposure to RF/MW radiation					
1985	3.18%	48.2	36.6	7.9	7.3
1990	3.94%	47.3	38.1	8.3	6.3
MEAN	3.6% = 3 860 ± 770	47.8	37.3	8.0	7.1
Cancer morbidity 1985 - 1990					
Total number of personnel		1900	1320	350	280
Number of neoplasms (N = 36)		14 (38.9%)	9 (25.0%)	7 (19.4%)	6 (16.7%)
Morbidity rate (per 100 000 per year)		146.9	135.8	401.4	427.0

Table 2 - Cancer cases in personnel exposed to strong rf/mw fields
Population size: N = 630; Cancer cases: N = 13; Morbidity rate: 412.7 per 100 000/year.

No.	Type of cancer	Age at diagn. (years)	Exp. period (years)	Average exposure levels during shift (W/m ²)		Calculated exposure doses (W x h/m ²)	
				Range	Mean	Annual	Life
1	Lymphoblastoma	54	12.5	6 - 8	7	4620	57 750
2	Larynx cancer	48	14	4 - 10	7	3850	53 900
3	Lymphoma	42	11	4 - 12	8	5280	58 080
4	Lymphosarcoma	51	21	6 - 12	9	5400	113 400
5	Chronic lymphatic laekemia	59	24.5	6 - 20	13	3900	95 550
6	Brain (astocytoma)	39	8	6 - 10	8	3520	28 160
7	Pancreatic cancer	46	13	4 - 10	7	4620	60 060
8	Chronic myelocytic laekemia	48	16	2 - 12	6	6160	98 560
9	Eye melanoma	55	22.5	6 - 40	23	5060	113 850
10	Acute myeloblastic laekemia	49	19	10 - 50	30	6600	125 400
11	Brain (glioma)	43	12	6 - 30	18	3960	47 520
12	Osteosarcoma	38	11	4 - 40	22	4840	53 240
13	Skin melanoma	41	14	10 - 40	23	5500	77 000
MEAN VALUE		47.15	15.26	2 - 50	13.92	4870	75 570.8
Standard deviation		6.46	5.01		8.20	926.32	30 515.1

forms of neoplasms (OR > 4.0). Workers exposed at lower power densities (1-2 and 2-6 W/m², respectively), showed a non-significant increase of cancer morbidity (OR 1.35 – 1.47), which requires confirmation on larger material. Monitoring of the RF/MW exposure during whole work shift revealed that the exposures appear to be transient, lasting few-several minutes, followed by long periods with low or very low exposures. However, the transient exposure periods, which count for a total of 2 – 4 hr during a 12-hr shift, are composed of variable intensities with incidental exposures at high levels (80 – 150 W/m², depending on type of work). Therefore, for evaluation of possible cancer risks, the exposure of workers should be expressed as a daily and cumulative (e.g. life) dose and not the average exposure level during the shift. E.g., for the average exposure level of 6 W/m², the individual daily dose was calculated for 15 - 20 Wxh/m² and the individual life exposure doses (which include type and period of occupation at the RF/MW environment) ranged 30000 – 60000 Wxh/m². In workers (e.g. radar technicians, RF/MW metrologists) who are exposed to RF/MW intensities exceeding the above thresholds we noted recently few cases of neoplasms, similar reports are available from other research centers. E.g. Richter ED¹³ described six young patients with different cancers which developed following high-level exposure to radar radiation (mean exposure 75 W/m², life exposure dosis 470 000 Wxh/m²).

Discussion and conclusions

Recently Degrave *et al.*¹² analysed causes of death among Belgian professional military radar operators in a 37-year retrospective cohort study. The authors conclude that exposure of professional military personnel to anti-aircraft radars that existed in Western Europe from the 1960s until the 1990s may have resulted in an increase in the incidence of hemolymphatic cancers (RR = 7.22). Similar results were reported earlier by Richter *et al.*¹³. The authors concluded that their findings suggest that young persons exposed to high levels of RF/MW radiation for long periods in settings where preventive measures were lax lived at increased risk for cancer. Very short latency periods suggest high risks from high-level exposures. Calculations derived from a linear model of dose-response suggest the need to prevent exposures in the range of 0.1-1 W/m².

In two meta-analyses of causes of death and cancer mortality in flight personnel, including civil and military pilots^{18,19}, it was documented that these groups remain at increased risk of various cancers, including hematolymphatic neoplasms. However, the authors point that both occupational exposures and well-established non-occupational risk factors may contribute to this increased risks. To better control for confounding factors and to identify exposures potentially amenable to preventive measures, future studies should compare risks within cohorts by flight routes, work history, and exposure to cosmic and UV radiation, electromagnetic fields, and chemical substances.

On the base of our epidemiologic study and review of the literature on possible cancer risks in workers exposed to RF/MW radiation, we conclude that the existing case reports of various neoplasms in radar personnel do not provide enough evidence for final conclusions on the risks and/or on thresholds for such risks. Nevertheless, a coherent pattern of data on development of various types of neoplasms, notably hematopoietic, in small groups of workers who are exposed to high intensities of RF/MW fields (e.g. radar technicians who tune and repair generators, metrologists who measure strong fields close to antennas, mobile phone technicians, etc.) strongly indicates a need for cumula-

tion of the existing data from various countries, as well as for extension of the studies. Reevaluation of our data from 1985-1990 epidemiologic study of Polish military personnel indicates that the thresholds for increased risk of cancer in RF/MW-exposed workers may be anticipated at exposures exceeding average power densities of 6 W/m^2 and life exposure doses of $30000\text{-}0000 \text{ Wxh/m}^2$. It remains still an open question whether or not the reported cases of neoplasms in workers and residents exposed to RF/MW field intensities which were below the above postulated thresholds can be linked to the influence of the EMF environment.

References

1. Korenstein-Ilan A, Barbul A, Hasin P, *et al.* Terahertz radiation increases genomic instability in human lymphocytes. *Radiat Res* 2008; 170: 224-34.
2. Stewart W. Mobile Phones and Health. Independent Expert Group on Mobile Phones – 2000. Chilton, Didcot, UK: National Radiological Protection Board, 2000.
3. Dolk H, Shaddick H, Walls P, *et al.* Cancer incidence near radio and television transmitters in Great Britain. Part I: Sutton Coldfield transmitter. *Amer J Epidemiol* 1997; 145: 1-9.
4. Dolk H, Elliot P, Shaddick H, *et al.* Cancer incidence near radio and television transmitters in Great Britain. Part II: All high power transmitters. *Amer J Epidemiol* 1997; 145: 10-7.
5. Hocking B, Gordon IR, Grain HL, *et al.* Cancer incidence and mortality and proximity to TV towers. *Med J Australia* 1996; 165: 601-5.
6. McKenzie DR, Yin Y, Morrell S. Childhood leukaemia and acute lymphoblastic leukaemia and exposure to broadcast radiation in Sydney - a second look. *Australian N Zeal J Public Health* 1998; 22: 360-7.
7. Michelozzi P, Capon A, Kirchmayer U, *et al.* Adult and childhood leukemia near a high-power radio station in Rome, Italy. *Am J Epidemiol* 2002; 155: 1096-103.
8. Park SK, Ha M, Im HJ. Ecological study on residences in the vicinity of AM radio broadcasting towers and cancer death: preliminary observations in Korea. *Int Arch Occup Environ Health* 2004; 77: 387-94.
9. Ha M, Im H, Lee M, *et al.* Radio-frequency radiation exposure from AM radio transmitters and childhood leukemia and brain cancer. *Am J Epidemiol* 2007; 166: 270-9.
10. Ha M, Lim HJ, Cho SH, *et al.* Incidence of cancer in the vicinity of Korean AM radio transmitters. *Arch Environ Health* 2003; 58: 756-62.
11. Merzenich H, Schmiedel S, Bennack S, *et al.* Childhood leukemia in relation to radio frequency electromagnetic fields in the vicinity of TV and radio broadcast transmitters. *Am J Epidemiol* 2008; 168: 1169-78.
12. Degraeve E, Meeusen B, Boniol M, *et al.* Causes of death among Belgian professional military radar operators: a 37-year retrospective cohort study. *Int J Cancer* 2009; 124: 945-51.
13. Richter ED, Berman T, Levy O. Brain cancer with induction periods of less than 10 years in young military radar workers. *Arch Environ Health* 2002; 57: 270-2.
14. Szmigielski S. Cancer morbidity in subjects occupationally exposed to high frequency (radiofrequency and microwave) electromagnetic radiation, *Science of the Total Environment (STOTEN)* 1996; 180: 9-19.
15. Szmigielski S, Sobiczewska E, Kubacki R. Carcinogenic potency of microwave radiation: overview of the problem and results of epidemiological studies on Polish military personnel. *European J Oncology* 2001; 6: 193-9.
16. WHO Working Group. Electromagnetic fields (300 Hz - 300 GHz). *Environmental Health Criteria Monograph No.137*, World Health Organization, Geneva, 1993.
17. Breckenkamp J, Berg G, Blettner M. Biological effects on human health due to radiofrequency/microwave exposure: a synopsis of cohort studies. *Radiat Environ Biophys* 2003; 42: 141-54.
18. Ballard T, Lagorio S, De Angelis G, *et al.* Cancer incidence and mortality among flight personnel: a meta-analysis. *Aviat Space Environ Med* 2000; 71: 216-24.
19. Buja A, Lange JH, Perissinotto E, *et al.* Cancer incidence among male military and civil pilots and flight attendants: an analysis on published data. *Toxicol Ind Health* 2005; 21: 273-82.

Wireless phone use and brain tumour risk

Lennart Hardell

Department of Oncology, University Hospital, SE-701 85 Örebro, Sweden

Abstract

The Hardell-group conducted during 1997-2003 two case-control studies on brain tumours including assessment of use of mobile phones and cordless phones. The questionnaire was answered by 905 (90%) cases with malignant brain tumours, 1,254 (88%) cases with benign tumours and 2,162 (89%) population-based controls. Regarding astrocytoma highest risk was found for ipsilateral mobile phone use in the > 10 year latency group, OR = 3.3, 95% CI = 2.0-5.4, and for cordless phone use OR = 5.0, 95% CI = 2.3-11. Also for acoustic neuroma, the highest OR was found for ipsilateral use and > 10 year latency yielding for mobile phone OR = 3.0, 95% CI = 1.4-6.2 and cordless phone OR = 2.3, 95% CI = 0.6-8.8. Overall highest OR for mobile phone use was found in subjects with first use < 20 years age. The annual age adjusted incidence of astrocytoma for the age group >19 years old increased statistically significantly by +2.16%, 95% CI +0.25 to +4.10 during 2000-2007 in Sweden in spite of seemingly underreporting of cases to the Swedish Cancer Registry. The Interphone studies are conducted under the auspice of the International Agency for Research on Cancer (IARC). The study design and epidemiological methods are compared with those in the Hardell group. It is concluded that while the Hardell group results appear to be sound and reliable, several of the Interphone findings display differential misclassification of exposure due to observational and recall bias, for example, following low participation rates in both cases and controls and bed-side computer guided interviews of cases rather than blinded interviews of cases and controls. However, a meta-analysis showed a consistent pattern of an association between mobile phone use and ipsilateral glioma and acoustic neuroma using ≥ 10 years latency period.

Key words: glioma, astrocytoma, mobile phone, cordless phone, age, incidence

Introduction

We are all exposed to extremely low frequency electromagnetic fields (ELF) from electrical and electronic appliances and power lines, and to radiofrequency/microwave

Address: Lennart Hardell, MD, PhD, Professor, Department of Oncology, University Hospital, SE-701 85 Örebro, Sweden - E-mail: lennart.hardell@orebroll.se

radiation emissions (RF) from wireless devices such as cell phones and cordless phones, cellular antennas and towers, and broadcast transmission towers¹. They constitute two types of electromagnetic fields (EMFs).

During the last decade there has been a rapid development of wireless technology and along with that an increased use of wireless telephone communication in the world. Most persons use mobile phones and cordless phones^{2,3}. Concerns of health risks have been raised, especially an increased risk for brain tumours since the brain is close to the radiation antenna both in mobile and cordless phones. The ipsilateral brain (same side as the mobile phone has been used) is most exposed, whereas the contralateral side (opposite side to the mobile phone) is much less exposed⁴. In the evaluation of the risk of brain tumours it is thus of vital importance to have information on the localisation of the tumour in the brain and which side of the head that has predominantly been used during phone calls.

Sweden was one of the first countries in the world to adopt this new technology. In the early 1980's analogue phones (NMT; Nordic Mobile Telephone System) were introduced on the market. During 1981 until December 31, 2007 NMT 450 (450 Megahertz; MHz) phones were used. NMT 900 (900 MHz) operated during 1986-2000.

The digital system (GSM; Global System for Mobile Communication) started in 1991 operating with dual band, 900 and 1,800 MHz. The third generation of mobile phones, 3G or UMTS (Universal Mobile Telecommunication System), using 1,900 MHz RF fields has been introduced worldwide since a few years, in Sweden in 2003. The fourth generation mobile phone system (4G) is now in the planning stage.

The desktop cordless phones (Digital Enhanced Cordless Telecommunication; DECT) have been used in Sweden since 1988, first analogue 800-900 MHz RF fields, but since early 1990's the digital 1,900 MHz system is used.

Most studies on the association between use of wireless phones and brain tumours are hampered by too short tumour-induction (latency) period. Since Sweden was one of the first countries to use this technology studies in our country would be possible for early findings on an association. So far results on long-term use come mainly from our research group (the Hardell group) and from the so-called Interphone study group. This is an international collaborative research group under the auspice of International Agency for Research on Cancer (IARC) in Lyon. Thirteen countries constitute the Interphone group. Inclusion period for cases varied between 1999-2004 depending on country. Eight countries have published their results and now six years after ending of the inclusion period results for glioma and meningioma have been published⁵.

In the following results from the Hardell group will be presented in some detail and a meta-analysis of all published results with at least 10 years latency period. Finally a comparison will be made between materials and methods in the Hardell group studies and Interphone studies.

Materials and methods

Our three studies on this topic were of the case-control type. Exposures were assessed by mailed questionnaires, as described in more detail in the different publications.

Our first case-control study on use of mobile phones and the association with brain tumours covered the study period 1994-1996. It included 209 (90%) cases and 425 (91%) controls that answered the mailed questionnaire^{6,7}.

This initial study was followed by two larger studies by us on the same topic. The same study methods were used and included in total the time period 1997-2003. All cases were reported to a cancer registry and had histopathological verification of tumour diagnosis. Controls were obtained from the National Population Registry. We included now also use of cordless phones, as well as more questions on e.g. occupational exposures. Use of wireless phones was carefully assessed by a self-administered questionnaire. The information was if necessary supplemented over the phone. The ear that had mostly been used during calls with mobile phone and/or cordless phone was assessed by separate questions; >50% of the time for one side, or equally both sides. This information was checked during the supplementary phone call and an additional letter to verify the accuracy of that information.

Tumour localisation was based on information in medical records and all tumour types were defined by using histopathology reports. The use of the wireless phone was defined in the present presentation as ipsilateral ($\geq 50\%$ of the time) and contralateral ($< 50\%$) in relation to tumour side. By information on the time period for use of the wireless phone and average number of minutes per day during that period we calculated latency time and cumulative use in hours over the years. Use in a car with external antenna was disregarded as well as use of a handsfree device. We adopted a minimum latency period of one year.

Only living subjects were included in our studies and in the second case-control study 1 429 (88%) cases that fulfilled the inclusion criteria and 1 470 (91%) controls participated during the study period (January 1, 1997 until June 30, 2000). The results regarding use of wireless phones have been published previously⁸⁻¹¹.

This study was followed by our third case-control study on the same topic. The methods were the same as in the second study using an identical questionnaire. The study period was from July 1, 2000 until December 31, 2003. In total 729 (89%) cases and 692 (91%) controls participated, as previously published^{12,13}.

We made pooled analysis of the two case-control studies on brain tumour cases diagnosed 1997-2003, both malignant¹⁴ and benign¹⁵. This was possible since the same methods with an identical questionnaire were used in both studies. For more details about the study design, see our previous publications.

Regarding tumour induction period it seems reasonable to analyse data from studies with at least 10 years latency period. It turned out that besides our studies^{14,15} only some publications from the Interphone group have such results¹⁶⁻²⁴.

Statistical methods

All analyses were done using StataSE 10.1 (Stata/SE 10.1 for Windows; StataCorp., College Station TX). Odds ratio (OR) and 95% confidence interval (CI) were calculated using unconditional logistic regression analysis. The unexposed category in the Hardell group studies consisted of subjects that reported no use of cellular or cordless phones. Adjustment was made for sex, age (as a continuous variable), socio-economic index (SEI) and year of diagnosis. The same year as for the case was used for the corresponding control. Random effects model was used for all meta-analysis, based on test for heterogeneity. The analyses were based on the adjusted ORs in the different studies.

Results

Different tumour types in the Hardell group studies

For astrocytoma grade I-IV mobile phone use yielded OR = 1.4, 95% CI = 1.1-1.7 increasing to OR 2.0, 95% CI = 1.5-2.5 for ipsilateral use, whereas no increased risk was found for contralateral use, Table 1¹⁴. OR increased further using > 10-year latency period for all use to OR 2.7, 95% CI = 1.8-3.9 and for ipsilateral use to OR = 3.3, 95% CI = 2.0-5.4. Also cordless phones yielded statistically significantly increased risk for astrocytoma. For 'other' types of malignant brain tumours the risk was statistically significantly increased for mobile phone use in the > 10 year latency group, highest in the ipsilateral group with OR = 2.6, 95% CI = 1.2-5.8.

Table 1 - Odds ratio (OR) and 95% confidence interval (CI) for malignant brain tumours. Numbers of exposed cases (Ca) and controls (Co) are given. Adjustment was made for age, sex, SEI, and year of diagnosis, c.f. Hardell *et al.*¹⁴

Type of tumour/ Type of telephone	All Ca/Co OR (CI)	Ipsilateral Ca/Co OR (CI)	Contralateral Ca/Co OR (CI)
Astrocytoma, grade I-IV (n=663)			
Mobile phone, > 1 year latency	346/900 1.4 1.1-1.7	229/374 2.0 1.5-2.5	98/308 1.0 0.7-1.4
>10 year latency	78/99 2.7 1.8-3.9	50/45 3.3 2.0-5.4	26/29 2.8 1.5-5.1
Cordless phone, > 1 year latency	261/701 1.4 1.1-1.8	167/309 1.8 1.4-2.4	81/235 1.2 0.8-1.6
>10 year latency	28/45 2.5 1.4-4.4	19/15 5.0 2.3-11	8/20 1.4 0.6-3.5
Other malignant (n=242)			
Mobile phone, > 1 year latency	122/900 1.2 0.9-1.7	65/374 1.4 0.9-2.1	39/308 1.0 0.6-1.5
>10 year latency	18/99 2.2 1.1-4.1	11/45 2.6 1.2-5.8	4/29 1.6 0.5-5.2
Cordless phone, > 1 year latency	89/701 1.2 0.8-1.7	40/309 1.0 0.6-1.6	35/235 1.2 0.7-1.8
>10 year latency	5/45 1.3 0.4-3.7	1/15 0.7 0.1-5.9	4/20 2.3 0.7-7.8

In Table 2 results are presented for acoustic neuroma¹⁵. For use of mobile phone OR = 1.7, 95% CI = 1.2-2.3 was calculated, and for cordless phone OR = 1.5, 95% CI = 1.04-2.0. Higher ORs were calculated for ipsilateral use, whereas no statistically signif-

Table 2 - Odds ratio (OR) and 95% confidence interval (CI) for benign brain tumours. Numbers of exposed cases (Ca) and controls (Co) are given. Adjustment was made for age, sex, SEI, and year of diagnosis, c.f. Hardell *et al.*¹⁵

Type of tumour/ Type of telephone	All Ca/Co OR (CI)	Ipsilateral Ca/Co OR (CI)	Contralateral Ca/Co OR (CI)
Acoustic neuroma (n=243)			
Mobile phone, > 1 year latency	130/900 1.7 1.2-2.3	80/374 1.8 1.2-2.6	48/308 1.4 0.9-2.1
>10 year latency	20/99 2.9 1.6-5.5	13/45 3.0 1.4-6.2	6/29 2.4 0.9-6.3
Cordless phone, > 1 year latency	96/701 1.5 1.04-2.0	67/309 1.7 1.2-2.5	28/235 1.1 0.7-1.7
>10 year latency	4/45 1.3 0.4-3.8	3/15 2.3 0.6-8.8	1/20 0.5 0.1-4.0
Meningioma (n=916)			
Mobile phone, > 1 year latency	347/900 1.1 0.9-1.3	167/374 1.3 1.01-1.7	125/308 1.1 0.8-1.4
>10 year latency	38/99 1.5 0.98-2.4	18/45 1.6 0.9-2.9	12/29 1.6 0.7-3.3
Cordless phone, > 1 year latency	294/701 1.1 0.9-1.4	134/309 1.2 0.9-1.6	101/235 1.1 0.8-1.5
>10 year latency	23/45 1.8 1.01-3.2	11/15 3.0 1.3-7.2	7/20 1.1 0.5-2.9
Other benign brain tumours (n=96)			
Mobile phone, > 1 year latency	49/900 1.5 0.9-2.5	11/374 1.4 0.5-3.8	12/308 2.1 0.8-5.3
>10 year latency	7/99 1.8 0.7-4.9	4/45 4.7 1.1-21	1/29 2.6 0.2-30
Cordless phone, > 1 year latency	34/701 1.5 0.8-2.5	8/309 1.5 0.5-4.3	9/235 2.0 0.7-5.5
>10 year latency	1/45 1.3 0.1-12	1/15 9.2 0.4-197	0/20 - -

icantly increased ORs were found for contralateral use. Ipsilateral use in the > 10 year latency period yielded for mobile phone OR = 3.0, 95% CI = 1.4-6.2, and for cordless phone OR = 2.3, 95% CI = 0.6-8.8, based on only 3 exposed cases.

Regarding meningioma ipsilateral mobile phone use gave OR = 1.3, 95% CI = 1.01-1.7 increasing to OR = 1.6, 95% CI = 0.9-2.9 in the > 10 year latency group, Table 2. For cordless phones highest OR was calculated using > 10 year latency period, OR = 3.0, 95% CI = 1.3-7.2 in the ipsilateral group. For other types of benign brain tumours no clear pattern of an association was found, although > 10 year latency use of mobile phone yielded OR = 4.7, 95% CI = 1.1-21 in the ipsilateral group. These results were however based on only 4 exposed cases, Table 2.

Age at first use of wireless phones

Subjects with first use of mobile phone < 20 years of age had highest risk for astrocytoma, OR = 5.2, 95% CI= 2.2-12, Table 3. Also for cordless phones highest OR was found in that age group, OR = 4.4, 95% CI = 1.9-10. Lower ORs were calculated for first use of a wireless phone at higher age. Similar results were found for acoustic neuroma; for mobile phone OR = 5.0, 95% CI = 1.5-16 in the youngest age group, Table 3^{14, 15, 25}. Regarding cordless phone only one case had first use < 20 years age, so no conclusions could be drawn. The same calculations for meningioma gave no statistically significantly increased ORs in the different age groups (data not in Table).

Meta-analysis of all published case-control studies

As has been discussed elsewhere most results in early studies on this topic were based on short latency periods²⁶. To evaluate true brain tumour risk, a longer latency period of perhaps decades may be necessary²⁷. Only the Hardell group and some of the Interphone studies have presented risk for latency period of at least 10 years. In contrast to the Hardell group almost all of the Interphone studies included use of cordless phones in the “unexposed” group; in two of these studies only briefly mentioned without proper result presentation, see Hardell *et al.*²⁸. A Danish cohort study on persons who were registered for the use of mobile phones sometimes during 1982-1995 was not included due to several methodological shortcomings as discussed in detail elsewhere²⁸. Thus, for example more than 200 000 corporate subscribers were excluded, i.e. the heaviest users, and no data on laterality of tumour and in relation to mobile phone use were presented. Such omission could dilute any observable risks.

Table 4 presents a summary of the results for latency period of 10 years or more^{26, 29}. For glioma a statistically significantly increased risk was found for ipsilateral mobile use, OR = 1.9, 95% CI = 1.4-2.4^{14, 17, 19, 21-23}, and for acoustic neuroma OR = 1.6, 95% CI = 1.1-2.4^{15, 16, 18, 20}. However, the risk was not statistically significantly increased for meningioma^{15, 17, 19, 22, 24}.

The Interphone studies

In Table 5 methodological aspects on the Hardell *et al.* and Interphone studies are presented. Several issues may be discussed, especially regarding the Swedish part since the author is very well aware of the Swedish medical system. The Interphone studies have also been discussed elsewhere, e.g. Hardell *et al.*²⁸.

Table 3 - Odds ratio (OR) and 95% confidence interval (CI) for astrocytoma and acoustic neuroma in different age groups, c.f. Hardell *et al.*^{14,15,25}. Numbers of exposed cases (Ca) and controls (Co) are given. Adjustment was made for age, sex, SEI, and year of diagnosis.

Age at first exposure/ Type of telephone	Astrocytoma Ca/Co OR (CI)	Acoustic neuroma Ca/Co OR (CI)
All ages, > 1 year latency		
Mobile phone	346/900 1.4 1.1-1.7	130/900 1.7 1.2-2.3
Cordless phone	261/701 1.4 1.1-1.8	96/701 1.5 1.04-2.0
<20, > 1 year latency		
Mobile phone	15/14 5.2 2.2-12	5/14 5.0 1.5-16
Cordless phone	14/16 4.4 1.9-10	1/16 0.7 0.1-5.9
20-49, > 1 year latency		
Mobile phone	208/555 1.5 1.1-2.0	86/555 2.0 1.3-2.9
Cordless phone	138/416 1.3 0.98-1.8	65/416 1.7 1.1-2.5
50-80, > 1 year latency		
Mobile phone	123/331 1.3 0.97-1.7	39/331 1.4 0.9-2.2
Cordless phone	109/269 1.5 1.1-2.0	30/269 1.3 0.8-2.1

Table 4 - Odds ratios (ORs) and 95% confidence intervals (CIs) for meta-analysis of six case-control studies on glioma, four on acoustic neuroma and five on meningioma using ≥ 10 year latency period. Numbers of exposed cases (Ca) and controls (Co) are given. For references, see text. Further details may be found in Hardell *et al.*²⁶ and Khurana *et al.*²⁹

	Total			Ipsilateral			Contralateral		
	No. of Ca/Co	OR	95% CI	No. of Ca/Co	OR	95% CI	No. of Ca/Co	OR	95% CI
Glioma	233/330	1.3	1.1 – 1.6	118/145	1.9	1.4 – 2.4	93/150	1.2	0.9 – 1.7
Acoustic neuroma	67/311	1.3	0.97 – 1.9	41/152	1.6	1.1 – 2.4	26/134	1.2	0.8 – 1.9
Meningioma	116/320	1.1	0.8 – 1.4	48/141	1.3	0.9 – 1.8	36/146	0.8	0.5 – 1.3

Table 5 - Methodological aspects on the Hardell et al and Interphone studies

Study design, methods	Hardell et al	Interphone
Type of study	Case/control	Case/control
Study period	1994-1996 ^{6,7} 1997-2003 ^{8,9}	Varying 1999-2004
Cases	Cancer registry	Hospitals (some checks with cancer registry)
Controls	Population registry	Populating registry/Practitioners list/ Random digit dialling
Status	Only living cases/controls	Also deceased cases included with proxy interviews Only living controls
Assessment of exposure	Questionnaire	Computer guided personal interview
Type and time for interview	<i>Cases:</i> about 2 months after diagnosis. Mailed questionnaire. <i>Controls:</i> Mailed questionnaire	<i>Cases:</i> Bedside face-to-face by nurses or medical students <i>Controls:</i> Face-to-face interviews usually in their home
Interview	Blinded as case or control	Not blinded as to case or control
Mobile phone use	Assessed	Assessed
Cordless phone use	Assessed	Not assessed (except for two studies)
Exposure, latency	Start \leq 1 year before diagnosis disregarded for cases. Same year for the matched control	< 1 year before diagnosis disregarded for cases. Referent date for controls = date of identification or mean of diagnosis date for cases
Exposure, time	Yes = any use; starting > 1 year before diagnosis	Yes = Regular mobile phone use on average once per week during at least 6 months; starting \geq 1 year before diagnosis (see above).
Unexposed	No use of mobile or cordless phones or use starting \leq 1 year before diagnosis	No or not regular mobile phone use or use < 1 year before diagnosis (see above). Note: use of cordless phone included in the unexposed group
Blinded coding	Yes	No. Computer based interviews with knowledge if it was a case or control
Data processing	Blinded as to case or control	Not stated (not blinded?)
Data used in presentation	Anytime (DECT or mobile phone)	Regular user

Both sets of studies had the case-control design, included both women and men and were performed during a similar time period, except for the first Hardell group study that included cases and controls for the time period 1994-1996^{6,7}. Our studies included cases and controls aged 20-80 years, whereas the Interphone studies included various age groups, mostly the age groups 20-69 years or 30-69 years^{28,30,31}.

The diagnosis of tumour type as well as grading is based on histopathology. X-ray investigation or MR alone is insufficient. Thus, all cases in the studies from the Hardell group had histopathological confirmation of the tumour type. Of the 371 cases with glioma in the Swedish Interphone study¹⁷ histopathology examination of the tumour was available for 328 (88%) and for 225 (82%) of meningioma. Thus, it is possible that cases without histology confirmation of the diagnosis may have had another type of brain tumour or even brain metastases. Such misclassifications inevitably bias the result towards unity. It is remarkable that 345 glioma cases were stratified according to grade I-IV, although histopathology was available only for 328 cases. In our studies on brain tumours we have histopathology verification of all of the diagnoses.

There are some discrepancies concerning number of cases identified in the Lönn *et al.*^{16,17} studies and data in the Swedish Cancer Registry. We used the Interphone criteria for case recruitment from the Swedish Cancer Registry. For example the Cancer Registry contained 469 cases with intracranial glioma cases compared with the 499 in the Interphone study, 337 meningioma cases *versus* 320, and 122 acoustic neuroma cases compared with 160 in the Interphone study^{16,17}. The Interphone study included cases from neurosurgery, oncology and neurology clinics as well as regional cancer registries in the study areas, and there seems thus to be inconsistency with the numbers in the Cancer Registry.

It should be pointed out that another weakness in the Swedish Interphone glioma and meningioma study was that for 33 glioma and 8 meningioma cases information on exposure was obtained from relatives, whereas no relatives of the controls were interviewed¹⁷. This might have introduced recall bias since it is probably difficult for relatives to know mobile phone habits, ear used during phone calls, type of phone etc. In our studies only living cases and controls were included. It is unlikely that excluding deceased cases would have biased the results unless use of wireless phones gives decreased OR for deceased cases; that is to balance an increased OR among living cases. In fact, we performed a case-control study on deceased cases with malignant brain tumour that were excluded from our studies¹⁴ using deceased controls. Results on the association of use of wireless phones confirmed our previous findings of an increased risk for malignant brain tumour among mobile phone users³².

Use of cellular telephones was mostly assessed by personal interviews in the Interphone studies. In contrast to our procedure, the interviewer was aware whether the interviewed person was a case (patient) or a control, thereby potentially introducing observational bias. It is not described how these personal interviews were organized, a tremendous task considering that vast parts of Sweden from north to south that had to be covered. In the sparsely populated and extended area in northern Sweden personal interviews must have meant lots of long distance travelling and imposed additional stress on the interviewers. No information was given in the articles on how or if this methodological problem was solved.

According to the provisions of the Interphone study the interviews were extensive and computer aided. It is likely that such an interview creates a stressful situation for a patient with a recent brain tumour diagnosis and operation. Mostly bedside interviews were performed during the patients' stay at the hospital, some even newly operated upon. These patients, especially under pressure, often have difficulties remembering past exposures and inevitably have problems with concentration and may have problems with other cognitive shortcomings. According to our experience a better option would have been to start with a mailed questionnaire, as we used for both cases and controls. Regarding cases the questions can be answered during a period of more well-being, and

if necessary supplemented by a telephone interview. This procedure has the additional advantage that it can be accomplished without disclosure whether a person is a case or a control during the data collection.

Observational bias might have been introduced in the Interphone studies since the interviewer knew if it was a case or a control that was being interviewed. In contrast, assessment of exposure and all further data processing until statistical analysis was blinded as to being a case or a control in our studies. Thus, we used the same method for assessment of exposure for cases and controls.

In one of the Interphone studies Mini-Mental State Examination was completed by 80% of the cases and 90% of the controls¹⁹. It was concluded that patients scored significantly lower than controls due to recalling words (aphasia), problems with writing and drawing due to paralysis. Certainly these cognitive defects would not be expected to the same extent for patients with acoustic neuroma and clearly in the Swedish Interphone studies the results for acoustic neuroma¹⁶ seem to be more sound and reliable than for glioma and meningioma¹⁷.

We included use of mobile or cordless phone 'any time' in the exposed group and made dose-response calculations based on number of hours of cumulative use. The unexposed group included also subjects with use of wireless phones with ≤ 1 year latency period.

On the contrary, mobile phone use in the Interphone studies was defined as 'regular use' on average once per week during at least 6 months, less than that was regarded as unexposed including also all use within < 1 year before diagnosis. This definition of 'regular use' seems to have been arbitrarily chosen and might have created both observational and recall bias in the interpretation of such a vague definition.

Use of cordless phones was not assessed or not clearly presented in the Interphone studies, e.g.^{16,22}. We found a consistent pattern of an association between cordless phones and glioma and acoustic neuroma^{14,15}. It has been shown that the GSM phones have a median power in the same order of magnitude as cordless phones³³. Moreover, cordless phones are usually used for longer calls than mobile phones^{14,15}. Including subjects using cordless phones in the "unexposed" group in studies on this issue, as for example in the Interphone investigations, would thus underestimate the risk and bias OR against unity.

Regarding glioma the Swedish Interphone study¹⁷ reported 23 ORs in Table 2 and 22 of these were < 1.0 and one OR = 1.0. For meningioma all 23 ORs were < 1.0 , six even statistically significantly so. These results indicate a systematic bias in the study unless use of mobile phones prevents glioma and meningioma, which is biologically unlikely. It should be noted that several of the overall ORs also in other Interphone studies were < 1.0 , some even statistically significantly so. As an example, in the Danish Interphone study on glioma¹⁹ all 17 ORs for high-grade glioma were < 1.0 , four even statistically significantly decreased.

In Table 6^{14-18,20-24,34-38} response rates for cases and controls in the various studies are presented. The case participation was good in our studies, 88% for cases with benign brain tumours, 90% for malignant brain tumour cases and 89% for the controls. On the contrary case participation varied from 37% to 93% and control participation from 42% to 75% in the Interphone studies. Obviously low participation rates for cases and controls might give selection bias and influence the results in the Interphone studies.

Among the controls in the glioma and meningioma study 282 (29%) refused to participate¹⁷. Among some of these non-responders a short interview was made and

Table 6 - Response rates (percent) in the Hardell et al and the Interphone studies. Numbers of interviewed cases are given. Note that for the Hardell et al pooled results are given from previously published original results.

Study	Response (number and percent)	
	Cases	Controls
Hardell <i>et al.</i> (Sweden) 2006 ^{14,15}		
- Benign brain tumours	1 254 (88%)	2 162 (89%)
- Malignant brain tumours	905 (90%)	
Lönn <i>et al.</i> (Sweden) 2004 ¹⁶		
- Acoustic neuroma	148 (93%)	604 (72%)
Lönn <i>et al.</i> (Sweden) 2005 ¹⁷		
- Glioma	371 (74%)	674 (71%)
- Meningioma	273 (85%)	
Christensen <i>et al.</i> (Denmark) 2004 ¹⁸		
- Acoustic neuroma	106 (82%)	212 (64%)
Christensen <i>et al.</i> (Denmark) 2005 ¹⁹		
- Glioma	252 (71%)	822 (64%)
- Meningioma	175 (74%)	
Schoemaker <i>et al.</i> (Five North European countries) 2005 ²⁰		
- Acoustic neuroma	678 (82%)	3 553 (42%)
Hepworth <i>et al.</i> (England) 2006 ²¹		
- Glioma	966 (51%)	1 716 (45%)
Schüz <i>et al.</i> (Germany) 2006 ²²		
- Glioma	366 (80%)	1 494 (61%)
- Meningioma	381 (88%)	
Takebayashi <i>et al.</i> (Japan) 2006 ³⁴		
- Acoustic neuroma	101 (84%)	339 (52%)
Klaeboe <i>et al.</i> (Norway) 2007 ³⁵		
- Glioma	289 (77%)	358 (69%)
- Meningioma	207 (71%)	
- Acoustic neuroma	45 (68%)	
Lahkola <i>et al.</i> (Five North European countries) 2007 ²³		
- Glioma	1 521 (60%; range 37-81%)	3 301 (50%; range 42-69%)
Hours <i>et al.</i> (France) 2007 ³⁶		
- Glioma	96 (60%)	455 (75%)
- Meningioma	145 (78%)	
- Acoustic neuroma	109 (81%)	
Schlehofer <i>et al.</i> (Germany) (2007) ³⁷		
-Acoustic neuroma	97 (89%)	194 (53%)
Takebayashi <i>et al.</i> (Japan) 2008 ³⁸		
- Glioma	88 (59%)	196 (53%)
- Meningioma	132 (78%)	279 (52%)
- Pituitary adenoma	102 (76%)	208 (49%)
Lahkola <i>et al.</i> (Five North European countries) 2009 ²⁴		
- Meningioma	1 209 (74%; range 55-90%)	3 299 (50%; range 42-69%)

only 34% reported regular use of a cellular telephone compared with 59% of the responders. If this discrepancy extends to the total group of non-responders the true percentage of mobile phone users in controls would be approximately 52%. Hence this figure would be lower than in glioma (58% exposed) and acoustic neuroma cases (60%). Only for meningioma with 43% exposed cases a lower percentage was reported, however, considering the sex ratio (women: men) for meningioma of about 2:1, a lower percentage of mobile phone users has to be expected due to the previously lower rate of users among women. It should be noted that a similar procedure in another Interphone study yielded similar results regarding mobile phone use among responders and non-responders³⁸.

Methodological issues in the Interphone studies have been discussed elsewhere^{39,40}. It was concluded that the actual use of mobile phones was underestimated in light users and overestimated in heavy users. Random recall bias could lead to large underestimation in the risk of brain tumours associated with mobile phone use. It was further suggested that selection bias in the Interphone study resulted in underselection of unexposed controls with decreasing risk at low to moderate exposure levels. Refusal to participate seemed to be related to less prevalent use of mobile phone⁴¹.

Discussion

A consistent pattern of an association between use of mobile or cordless phones and ipsilateral astrocytoma and acoustic neuroma was found in the studies from the Hardell group. The risk increased for both tumour types with time since first use and was highest in the group with > 10 year latency. For biological reasons this is what one would expect for a carcinogenic effect for use of wireless phones. The brain is a near-field organ for such exposure and highest risk in the > 10 year latency period would be expected. Aspects on the used methods, interpretation of results and discussion of other studies in this area may be found in our different studies in this area as have previously been published^{25, 28, 31}.

No other studies than from the Hardell group have published comprehensive results for use of cordless phones. As we have discussed in our publications it is pertinent to include also such use in this type of studies. Cordless phones are an important source of exposure to microwaves and they are usually used for a longer time period on daily basis as compared to mobile phones. Thus, to exclude such use, as was done in e.g. the Interphone studies, could lead to an underestimation of the risk for brain tumours from use of wireless phones.

Of special concern is the five-times higher risk for both astrocytoma and acoustic neuroma among cases that started mobile phone use before the age of 20. Similar results were found for astrocytoma and cordless phone use²⁵. The results were based on low numbers of exposed cases and controls, but are still statistically significant. Regarding acoustic neuroma and cordless phones the results were inconclusive, since only one case had used a cordless phone before the age of 20. A much lower risk was found in older age groups. From a biological point of view these results are credible since the developing brain would be more sensitive to carcinogens. These results are worrying regarding children since the brain is more exposed to microwaves during mobile phone calls in young persons due to smaller head and thinner bone, as has been discussed elsewhere^{4,27}.

The meta-analysis on use of mobile phones and the association with brain tumours included all case-control studies that we have identified in the peer-reviewed literature. Most studies have published data with rather short latency period and limited information on long-term users, and the results using 10-year latency period are based on rather low numbers. In spite of that, also the meta-analysis yielded a consistent pattern of an increased risk for acoustic neuroma and glioma after ≥ 10 years mobile phone use, thus confirming the results from the Hardell group.

It should be mentioned that another meta-analysis that did not include our studies found a statistically significant association between mobile phone use and all brain tumours using ≥ 10 years latency period with OR = 1.25, 95% CI = 1.01-1.54⁴².

During 1970-2007 the annual age adjusted incidence increased statistically significantly for all brain tumours with +0.28%, 95% CI = +0.04 to +0.52 in Sweden (<http://www.socialstyrelsen.se/Statistik/statistikdatabas/index.htm>). The age-adjusted incidence of astrocytoma increased during 2000-2007 yearly with +1.55%, 95% CI = -0.15 to +3.27, statistically significantly so among women. In the age group > 19 years the annual change was statistically significant for astrocytoma, +2.16%, 95% CI = +0.25 to +4.10²⁵. These results are remarkable not the least since there seems to be a large underreporting of brain tumour cases to the Swedish Cancer Registry⁴³.

It should be pointed out that in the Swedish part of the Interphone studies, one of the authors (Ahlbom) had stated, even before the study started, that an asserted association between cellular telephones and brain tumours is 'biologically bizarre' in an 'opinion' letter⁴⁴. This statement might preclude him from objectivity in his own investigation and has been rebutted⁴⁵. The so-called REFLEX-study indicates that there are in fact biological mechanisms that could link exposure to the development of diseases such as brain tumours⁴⁶.

Interestingly, one of the authors of the 'opinion' letter, Professor Adami together with Professor Trichopoulos stated in an Editorial⁴⁷ in the same issue of New England Journal of Medicine as the US study on mobile phone use and brain tumours by Inskip *et al.*⁴⁸ was published that ... 'the use of cellular telephones does not detectably increase the risk of brain tumours' and that 'This study allays fears raised by alarmist reports that the use of cellular telephones causes cancer'. This statement goes far beyond what is scientifically defensible, e.g. longest duration for use was only ≥ 5 years and no data with 10 years latency were presented. Maybe this editorial was biased by not reported conflicts of interest by the authors as exemplified elsewhere^{45,49}.

Also another person who participated in the Swedish part of the Interphone studies, Professor Feychting, has made a most remarkable comment on our studies when she "wonders if the questions really were placed in the same way to cases and controls"⁵⁰. For methodological reasons this comment is of course not true. On the contrary, different methods seem to have been used for interviews of cases and controls in the Interphone study, see above, where Professor Feychting participated. Certainly these circumstances show how economical and other not disclosed interests might influence this research area and preclude objective risk evaluation. Still these attacks on our research are few in an international perspective and almost exclusively made by a few Swedish researchers with their own not disclosed research agenda⁴⁵. This type of unfounded critique needs to be rebutted and is quite in contrast to some recent international publications⁵¹⁻⁵³.

In summary there is consistent evidence of an increased risk for glioma and acoustic neuroma after ≥ 10 years latency for use of mobile or cordless phones. Especially worrying is the finding of highest risk in persons with first use of a mobile phone before

the age of 20 in the study from the Hardell group. The current guideline for exposure to microwaves from wireless phones is not safe and needs to be revised.

Epilogue

The overall results from the Interphone study group were recently published for glioma and meningioma⁵. The response rate was for meningioma cases 78% (range 56-92%), for glioma cases 64% (range 36-92%), and for controls 53% (range 42-74%). No association was found for meningioma. For glioma OR = 1.40, 95% CI = 1.03-1.89, was calculated in the group with highest cumulative use of mobile phone, ≥ 1640 h. For ipsilateral use the risk increased further to OR = 1.96, 95% CI = 1.22-3.16. Highest risk was found in the temporal lobe, the anatomical area with highest exposure. Overall statistically significantly decreased risk was found both for meningioma and glioma indicating bias in the study as also discussed by the authors. Consequently OR was biased towards unity in the highest exposure group. Using the lowest exposure group as reference entity yielded for glioma and latency ≥ 10 years OR = 2.18, 95% CI = 1.43-3.31 and for cumulative use ≥ 1640 h OR = 1.82, 95% CI = 1.15-2.89. These results are thus consistent with our findings and give further evidence of an association between mobile phone use and glioma.

Acknowledgement

Supported by grants from Cancer- och Allergifonden, Cancerhjälpen and Örebro University Hospital Cancer Fund. Contribution by co-workers in the various publications is acknowledged.

References

1. Hardell L, Sage C. Biological effects from electromagnetic field exposure and public exposure standards. *Biomed Pharmacother* 2008; 62: 104-9.
2. Söderqvist F, Hardell L, Carlberg M, *et al.* Ownership and use of wireless telephones: a population-based study of Swedish children aged 7-14 years. *BMC Public Health* 2007; 7: 105.
3. Söderqvist F, Carlberg M, Hardell L. Use of wireless telephones and self-reported health symptoms: a population-based study among Swedish adolescents aged 15-19 years. *Environ Health* 2008; 21;7:18.
4. Cardis E, Deltour I, Mann S, *et al.* Distribution of RF energy emitted by mobile phones in anatomical structures of the brain. *Phys Med Biol* 2008; 53: 2771-83.
5. The INTERPHONE Study Group. Brain tumour risk in relation to mobile telephone use: results of the INTERPHONE international case-control study. *Int J Epidemiol* 2010; 39: 675-94.
6. Hardell L, Näsman A, Pålsson A, *et al.* Use of cellular telephones and the risk for brain tumours: A case-control study. *Int J Oncol* 1999; 15: 113-6.
7. Hardell L, Hansson Mild K, Pålsson A, *et al.* Ionizing radiation, cellular telephones and the risk for brain tumours. *Eur J Cancer Prev* 2001; 10: 523-9.
8. Hardell L, Hallquist A, Hansson Mild K, *et al.* Cellular and cordless telephones and the risk for brain tumours. *Eur J Cancer Prev* 2002; 11: 377-86.
9. Hardell L, Hansson Mild K, Carlberg M. Case-control study on the use of cellular and cordless phones and the risk for malignant brain tumours. *Int J Radiat Biol* 2002; 78: 931-6.
10. Hardell L, Hansson Mild K, Carlberg M. Further aspects on cellular and cordless telephones and brain tumours. *Int J Oncol* 2003; 22: 399-407.
11. Hardell L, Hansson Mild K, Carlberg M, *et al.* Vestibular schwannoma, tinnitus and cellular telephones. *Neuroepidemiology* 2003; 22: 124-9.

12. Hardell L, Carlberg M, Hansson Mild K. Case-control study on cellular and cordless telephones and the risk for acoustic neuroma or meningioma in patients diagnosed 2000-2003. *Neuroepidemiology* 2005; 25: 120-8.
13. Hardell L, Carlberg M, Hansson Mild K. Case-control study of the association between the use of cellular and cordless telephones and malignant brain tumors diagnosed during 2000-2003. *Environ Res* 2006; 100: 232-41.
14. Hardell L, Carlberg M, Hansson Mild K. Pooled analysis of two case-control studies on use of cellular and cordless telephones and the risk for malignant brain tumours diagnosed in 1997-2003. *Int Arch Occup Environ Health* 2006; 79: 630-9.
15. Hardell L, Carlberg M, Hansson Mild K. Pooled analysis of two case-control studies on the use of cellular and cordless telephones and the risk of benign brain tumours diagnosed during 1997-2003. *Int J Oncol* 2006; 28: 509-18.
16. Lönn S, Ahlbom A, Hall P, *et al.* Mobile phone use and the risk of acoustic neuroma. *Epidemiology* 2004; 15: 653-9.
17. Lönn S, Ahlbom A, Hall P, *et al.* Swedish Interphone Study Group. Long-term mobile phone use and brain tumor risk. *Am J Epidemiol* 2005; 161: 526-35.
18. Christensen HC, Schüz J, Kosteljanetz M, *et al.* Cellular telephone use and risk of acoustic neuroma. *Am J Epidemiol* 2004; 159: 277-83.
19. Christensen HC, Schüz J, Kosteljanetz M, *et al.* Cellular telephones and risk for brain tumors: a population-based, incident case-control study. *Neurology* 2005; 64: 1189-95.
20. Schoemaker MJ, Swerdlow AJ, Ahlbom A, *et al.* Mobile phone use and risk of acoustic neuroma: results of the Interphone case-control study in five North European countries. *Br J Cancer* 2005; 93: 842-8.
21. Hepworth SJ, Schoemaker MJ, Muir KR, *et al.* Mobile phone use and risk of glioma in adults: case-control study. *BMJ* 2006; 332: 883-7.
22. Schüz J, Böhler E, Berg G, *et al.* Cellular phones, cordless phones, and the risks of glioma and meningioma (Interphone Study Group, Germany). *Am J Epidemiol* 2006; 163: 512-20.
23. Lahkola A, Auvinen A, Raitanen J, *et al.* Mobile phone use and risk of glioma in 5 North European countries. *Int J Cancer* 2007; 120: 1769-75.
24. Lahkola A, Salminen T, Raitanen J, *et al.* Meningioma and mobile phone use—a collaborative case-control study in five North European countries. *Int J Epidemiol* 2008; 37: 1304-13.
25. Hardell L, Carlberg M. Mobile phones, cordless phones and the risk for brain tumours. *Int J Oncol* 2009; 35: 5-17.
26. Hardell L, Carlberg M, Hansson Mild K. Epidemiological evidence for an association between use of wireless phones and tumor diseases. *Pathophysiology* 2009; 16: 113-22.
27. Sage C, Carpenter DO. Public health implications of wireless technologies. *Pathophysiology* 2009; 16: 233-46.
28. Hardell L, Carlberg M, Hansson Mild K. Methodological aspects of epidemiological studies on the use of mobile phones and their association with brain tumors. *Open Env Sciences* 2008; 2: 54-61.
29. Khurana VG, Teo C, Kundi M, *et al.* Cell phones and brain tumors: a review including the long-term epidemiologic data. *Surg Neurol* 2009; 72: 205-14.
30. Hardell L, Carlberg M, Söderqvist F, *et al.* Long-term use of cellular phones and brain tumours: increased risk associated with use for ≥ 10 years. *Occup Environ Med* 2007; 64: 626-32.
31. Hardell L, Carlberg M, Söderqvist F, *et al.* Meta-analysis of long-term mobile phone use and the association with brain tumours. *Int J Oncol* 2008; 32: 1097-103.
32. Hardell L, Carlberg M, Hansson Mild K. Mobile phone use and the risk for malignant brain tumors: A case-control study on deceased cases and controls. *Neuroepidemiology* 2010; 35: 109-14.
33. Hansson Mild K, Hardell L, Kundi M, *et al.* Mobile telephones and cancer: is there really no evidence of an association? (review). *Int J Mol Med* 2003; 12: 67-72.
34. Takebayashi T, Akiba S, Kikuchi Y, *et al.* Mobile phone use and acoustic neuroma risk in Japan. *Occup Environ Med* 2006; 63: 802-7.
35. Klæboe L, Blaasaas KG, Tynes T. Use of mobile phones in Norway and risk of intracranial tumours. *Eur J Cancer Prev* 2007; 16: 158-64.
36. Hours M, Bernard M, Montestrucq L, *et al.* Cell phones and risk of brain and acoustic nerve tumours: the French INTERPHONE case-control study. *Rev Epidemiol Sante Publique* 2007; 55: 321-32.

37. Schlehofer B, Schlaefer K, Blettner M, *et al.* Environmental risk factors for sporadic acoustic neuroma (Interphone Study Group, Germany), *Eur J Cancer* 2007; 43: 1741-7.
38. Takebayashi T, Varsier N, Kikuchi Y, *et al.* Mobile phone use, exposure to radiofrequency electromagnetic field, and brain tumour: a case-control study. *Br J Cancer* 2008; 98: 652-9.
39. Vrijheid M, Cardis E, Armstrong BK, *et al.* Validation of short term recall of mobile phone use for the Interphone study. *Occup Environ Med* 2006; 63: 237-43.
40. Vrijheid M, Deltour I, Krewski D, *et al.* The effects of recall errors and of selection bias in epidemiologic studies of mobile phone use and cancer risk. *J Expo Sci Environ Epidemiol* 2006; 16: 371-84.
41. Vrijheid M, Richardson L, Armstrong BK, *et al.* Quantifying the impact of selection bias caused by nonparticipation in a case-control study of mobile phone use. *Ann Epidemiol* 2009; 19: 33-41.
42. Kan P, Simonsen SE, Lyon JL, *et al.* Cellular phone use and brain tumor: a meta-analysis. *J Neurooncol* 2008; 86: 71-8.
43. Barlow L, Westergren K, Holmberg L, *et al.* The completeness of the Swedish Cancer Register: a sample survey for year 1998. *Acta Oncol* 2009; 48: 27-33.
44. Adami HO, Ahlbom A, Ekblom A, *et al.* Opinion – "Experts who talk rubbish". *Bioelectromagnetics Society Newsletter* 2001; 162: 4-5.
45. Hardell L, Walker MJ, Walhjalt B, *et al.* Secret ties to industry and conflicting interests in cancer research. *Am J Ind Med* 2007; 50: 227-33.
46. REFLEX. Risk Evaluation of Potential Environmental Hazards From Low Frequency Electromagnetic Field Exposure Using Sensitive *in vitro* Methods. Final Report 2005. Available from: http://www.itis.ethz.ch/downloads/REFLEX_Final%20Report_171104.pdf
47. Trichopoulos D, Adami HO. Cellular telephones and brain tumors. *N Engl J Med* 2001; 344: 133-4.
48. Inskip PD, Tarone RE, Hatch EE, *et al.* Cellular-telephone use and brain tumors. *N Engl J Med* 2001; 344: 79-86.
49. Michaels D. Doubt is their product. How industry's assault on science threatens your health. Oxford University Press, New York, 2008.
50. Björkstén U. Vetenskap ur funktion. Forskningen om biologiska effekter av mobiltelefoni ("Science out of order. The research on biological effects from use of mobile phones"). Atlantis, Stockholm, Sweden 2006, 64. (In Swedish)
51. Kundi M. The controversy about a possible relationship between mobile phone use and cancer. *Environ Health Perspect* 2009; 117: 316-24.
52. Mead MN. Tough call: Challenges to assessing cancer effects of mobile phone use. *Environ Health Perspect* 2009; 117: A116.
53. Myung SK, Ju W, McDonnell DD, *et al.* Mobile phone use and risk of tumors: a meta-analysis. *J Clin Oncol* 2009; 27: 5565-72.

Occupational EMF exposure measurements in different work environments

Nesrin Seyhan*, **, Arzu Firlarer*, ***, Ayse G. Canseven*, **, Semih Özden*, Semra Tepe Çam**

* Gazi Non-Ionizing Radiation Protection Center (GNRK), Gazi University Faculty of Medicine
06500 Besevler, Ankara, Turkey

** Gazi University Faculty of Medicine Biophysics Department, 06500 Besevler, Ankara, Turkey

*** Gazi University Health Sciences Institute Occupational Health and Safety Department, 06500
Besevler, Ankara, Turkey

Abstract

Electromagnetic field exposures vary substantially between industries, occupations and individuals. In factories and large commercial buildings with huge number of office equipments like computers, photocopies, fax machines, and video display units, the occupants are exposed to 50-Hz magnetic fields (MF) and radiofrequency (RF) fields. The objective of this EMF occupational exposure measurement study was to characterize occupational MF personal exposure among operators using office equipments and/or industrial workstations at least 8 hours per day. Measurements were performed in two national banks, one gasoline injection factory and one international satellite and cable operator. This survey was designed to measure the mean and maximum MF magnitudes at extremely-low frequency (ELF) with a Narda EFA-300 meter and its isotropic probes. Based on our findings, it is strongly recommended that periodic EMF exposure measurements should be done to obtain more detailed understanding of workplace exposures and their sources. And the results should be considered in the evaluation of risk assessment that would help to minimize the possibility of workers being harmed by work-related exposure to nonionizing electromagnetic sources. Occupational exposure standards considering the precautionary principle approach relating to adverse health effects should promptly be legislated in Turkey and throughout the world.

Key words: ELF MFs, EMF measurements, EMF exposure, risk assessment, EFA-300, occupational EMF exposure

Introduction

Electromagnetic fields (EMF) occur in nature and thus have always existed on earth. However, during the twentieth century, environmental exposure to man-made sources of

Address: Arzu Firlarer, Gazi Üniversitesi Tıp Fakültesi Biyofizik Abd., Dekanlık Binası 5. Kat, 06500 Besevler Ankara/Turkey - Tel: +(90)312-202 46 79 - Fax: +90 312 212 90 23
E-mail: afirlarer@gmail.com

EMF continually increased due to electricity demand, ever advancing wireless technologies and changes in work practices and social behavior. Everyone is exposed to electric and magnetic fields at many different frequencies, at home and at work. Magnetic and electric fields are complex entities that can be characterized by their frequency, waveform, polarization, and amplitude. As a result, there are potentially several different parameters that can be used to define exposure¹.

Interest in electromagnetic fields as a possible cause of cancer was first noted by Wertheimer and Leeper² when they observed an association between electromagnetic fields from overhead power lines and childhood leukemia. During an investigation of occupational mortality, Milham³ similarly reported that leukemia mortality of adults occupationally exposed to electric or magnetic was increased. Possible associations between leukemia and electromagnetic fields are still being investigated in epidemiological studies; the most detailed ones are constructed from exposure measurements of the present day workforce^{4,5}. Analyses of data from a number of well-conducted studies showed a clearly twofold increase in risk associated between power-frequency magnetic field exposure above 4 mG (milliGauss) and childhood leukemia⁶. This paper presents the exposure levels of work-related electromagnetic fields measured by GNRK from four different occupational sites in which industrial and office equipments were used during working period.

Occupational EMF exposure

Since outside power lines are only predictive of magnetic fields and no known long-term electric field indicators are available, residential studies of childhood cancer have all been explicitly or implicitly focused on magnetic fields. Occupational studies are less clear in terms of which field types are present; for many electrical occupations, both electric and magnetic fields are likely to be present. In the environment of electric utility industry, the most extensively studied sector, both field types are raised⁴.

Occupational settings can be expected to show more varieties than residential exposure. There is more opportunity for intermittent very high exposures to electric and magnetic fields rarely encountered in the home. The diversity of field frequencies can be much greater, not limited to relatively pure 50 or 60 Hz fields. Varying work practices can give rise to markedly different exposure patterns over the workday. Among electric utility workers, for example, linemen would often spend several hours at near zero exposure while driving to the work site and then spend an hour in a magnetic field of 20 or 30 mG, then drive back to the base with zero exposure again. In contrast, power station operators are more likely to be exposed to a steady magnetic field of perhaps 5 to 10 mG for the entire work shift. Most work occurs during the daytime, but a sizable proportion of the workforce is engaged in shift work and receives exposures at night. The biological significance, if any, of these differing patterns of exposure is presently unknown, but the workplace offers more diversity to study than the residential environment^{4,9}.

The notion of "electrical worker" has probably been too narrowly conceived to adequately reflect the diversity of settings in which elevated EMF is encountered. Milham's original list was based on intuitive perceptions of which electrical workers are, with real questions about whether such occupations as "electrical engineer" are truly exposed to elevated field levels and omitting the broad array of workers who spend extensive periods of time near electrical equipment such as photocopiers, video display terminals, or sewing machines^{4,9}.

Surveys of additional groups of potentially exposed workers are needed, initially including all whose jobs involve close proximity to electrical equipment for extended periods of time. Advances in meters for assessing EMF allow for surveys of workplaces and personal monitoring with relatively modest expense and inconvenience. By broadening the research to include workers in more diverse settings, there is a greater opportunity to evaluate the biological significance of varying exposure patterns. Perhaps, unexpected result among the candidate populations is one that is exposed to the true “magnetotoxin” that will show dramatic elevations in cancer ^{4,9}.

EMF guidelines and limits

A number of national and international organizations have formulated guidelines establishing limits for occupational and residential EMF exposure. These organizations include the International Radiation Protection Association/International Non-Ionizing Radiation Committee (IRPA/INIRC, 1990), the Comité Européen de Normalization Electrotechnique (CENELEC, 1995), the National Radiological Protection Board in the United Kingdom (NRPB, 1993), Deutsches Institut für Normung-Verband Deutscher Elektrotechniker (DIN/VDE, 1995), the American Conference of Governmental Industrial Hygienists (ACGIH, 1996), and the International Commission on Non-Ionizing Radiation Protection (ICNIRP, 1998). Guidelines focus on prevention of acute neural and cardiac effects. Evidence of potential long-term effects such as cancer is considered insufficient for guideline formulation.

Earlier guidelines specified limits for the ‘whole working day’, with relaxed values for shorter exposures. Later guidelines¹⁰ (ACGIH, 1998; ICNIRP, 1998) specified momentary or ceiling limits and eliminated short-term exposure limits, which had permitted considerably higher field exposures for limited, but not insignificant, periods of time (hours). Overall, magnetic field guidelines have become progressively more stringent, culminating with the latest ICNIRP (1998) guidelines ¹⁰⁻¹².

For occupational groups, the ICNIRP guidelines specify reference levels (defined as levels at which action should be taken) for electric and magnetic fields of 10 kV/m and 5 G for 50-Hz and 8.3 kV/m and 4.2 G for 60-Hz fields. For the general public, electric and magnetic field reference levels are 5 kV/m and 1 G for 50-Hz and 4.2 kV/m and 0.83 G for 60-Hz fields ¹⁰⁻¹².

Based in part on ICNIRP standards, the German federal government published the first national EMF regulation for residential exposure in 1996 (Federal Government of Germany, 1996). As a result of public pressure in several countries, the European Union has adopted a recommendation based on a modified version of ICNIRP guidelines for residential exposure. Much stricter limits (2–10 mG) have been adopted in Switzerland (Swiss Federal Council, 1999) and proposed in Italy ¹⁰⁻¹².

In the US, several state and local governments have adopted electric and magnetic field limits for transmission lines. These limits, established by regulations in some states (e.g. Florida) and by informal guidelines in others (e.g. Minnesota), are on the order of 10 kV/m within rights-of-way and 2 kV/m at the edge of rights-of-way for electric fields and around 200 mG for magnetic fields. Much more stringent limits for magnetic field exposure (on the order of 2–4 mG at the edge of rights-of-way) have been adopted in some local ordinances ¹⁰⁻¹².

Studies of GNRK

The scientific world has focused on the biological effects of electromagnetic fields (EMF) from base stations, mobile phones, TV and radio transmitters, Dect telephones, MRI and diathermy units, transformers, microwave ovens, radar systems, security systems and high intensity power lines for more than 40 years. These sources are all belong to the non-ionizing radiation (NIR) part of the electromagnetic spectrum.

All EU countries have their own Non-Ionizing Radiation Centers and/or Laboratories. NIR's include electric and magnetic fields and radiations, optical radiations (UV, visible and infrared) and ultrasound. These centers have important mission in order to take precaution from electromagnetic fields in the range of 0-300 GHz radiation. In our country, the only NIR center is GNRK – Gazi Non-Ionizing Radiation Protection Center (www.gnrk.gazi.edu.tr). GNRK and related measurement laboratory is established in July 2005 by the Biophysics Department of Gazi University in Ankara, having primarily working on area of health and biological effects of NIR along with measurement of radiation from NIR sources between 5 Hz and 60 GHz frequency.

ELF and RF radiation measurement for personal or institutional orders in/near/under; house, office, school, hospital (MRI, diathermy units), industrial sites, base stations, radar units, TV and radio transmitters, high voltage power lines are being carried out. GNRK interprets the measurement results in health perspective with respect to the national and international standards.

GNRK investigates the effects of EM fields on human health, provides consulting to people who are interested in working or living in the similar area of the GNRK Center (not clear what this means), provides expertise reports for lawsuits of the effects of ELF and RF radiation health effects, provides counselling and gives educational briefs to ministries for the preparation of acts to protect people and workers from EMF.

GNRK provides public and occupational training for the measurement of EMF, prepares brochures for people, workers and students on protection from EMF exposure, maintains a web site of the center while providing written and oral information resource which consists of EMF and biological effects, environmental radiation sources and field strength to inform people.

The Biophysics Department has worked on Biological Effects of Non-Ionizing Electromagnetic Fields for more than 25 years. For this aim the Bioelectromagnetics Laboratory, the Tissue Analysis Laboratory and the Gazi Non-Ionizing Radiation Protection Center were established. In these laboratories, application of RF fields, ELF magnetic and electric fields to biological systems, dosimetry of ELF and RF fields and modeling, biological and health effects of ELF and RF radiation, methods of measurement of EMF are being investigated¹³⁻¹⁹.

Subjects and methods

The study subjects had worked 8 hr/day for 1-5 years in administrative units, administrative information technologies departments of two National Banks, one Industrial Company and satellite control rooms of an international operator having more than 500 employees, where the offices are equipped fully with electronic devices.

Measurements of exposures were obtained directly from employees under usual working conditions in 2007 and 2008, during a workday (between 9:00 to 17:00). Meas-

urement of magnetic field intensity was performed with a Narda EFA-300 meter (Narda; Pfulingen, Germany) and an isotropic magnetic field probe with a bandwidth of 5 Hz - 32 kHz.

The measured MFs in the office environment varied from 1.33 mG (mean) to 424.32 mG (maximum) and in the factory environment values from industrialized equipments varied from 15.72 mG (mean) to 6.15 Gauss (maximum).

Measurements in the national bank-1 (NB-1)

Measurements were done in four different floors where uninterruptible power sources (UPS), electric enclosures were placed in Cellar-1; administration units, telephone central and energy monitoring unit were placed in Cellar-2; electric enclosures and technician room were placed in Cellar-3 and communication service was placed in Ground Floor. Communication service was placed above the electric enclosures and behind a diesel generator. Office equipments were densely used in the administrative unit and communication service. Measurements were performed totally in 97 points considering the electromagnetic fields emitted from office equipments, electric enclosures and UPS²⁰.

Measurements in the national bank-2 (NB-2)

In the data processing center of NB-2, it was aimed to determine the occupational EM radiation level and the effect of possible health effects on the office workers (using computers at least 6 h/day), system operators (printing machines, automated teller machines-ATM) and technicians.

The data processing center was composed of 5 floors. In the cellar, there were electric enclosures and UPS; on the Ground Floor, there were system rooms, printing center and offices. Servers and data processing machines, office rooms and some project managers' rooms were placed on the first floor. Technical and project rooms where mostly office equipments were used are on the second floor. The call center was on the last floor. Besides, there was a high voltage line situated 30 meters away.

Measurements were performed where EM sources were many and workers mostly spent their time using isotropic probes at 5 Hz – 32 kHz frequency range. The total measurement points were 140 and the results were given in RMS²¹.

Measurements in gasoline injection factory (GIF)

Electromagnetic field sources in the gasoline factory were computer numerical control (CNC) workbenches in production lines, transformers, electric enclosures, hardening furnaces and melting furnaces. Measurements were performed in 237 points considering the near field of the sources and the locations of the workers/operators²².

Measurements in the international satellite and cable operator (ISCO)

EMF sources inside the ISCO campus were cable TV satellites, outside broadcast vehicle, infrastructure equipments, administrative buildings, transformers and lodging buildings. Power system of antennas named "shelter" that provided communication between antenna and received/transmitted signals were located apart from the antenna.

Besides, control systems and engines that can move the antenna and make the connection between signals were inside the shelter. Outside broadcast vehicle was consisted of control equipments and an antenna which transmitted the image from the cameras to the satellite. Measurements were performed in 223 points considering the near field of the sources, the locations and the working time intervals of the workers/operators²³.

Results and conclusion

In four different companies having totally 5,632 workers/operators, measurements were performed in 697 points. According to these results, about 72% of the staff is under the risk according to IARC and WHO 2001 classifications. As presented in Tables 1-4, the highest mean and maximum MF values were seen in the gasoline injection factory where hardening and melting furnaces are being used. The common problem of these companies is offices located either near the electric enclosures or close to high-power electrical appliances.

Table 1 - NB-1 measurement results

Location	Mean (mG)	S.D. (mG)	Maximum (mG)
UPS technician room	47.25	22.50	84.80
Administration Department	8.06	3.06	55.30
Office equipped fully with CRT monitors	12.37	5.35	33.80
Communication Service	34.50	8.56	165.00
Office above electric enclosure, equipped with CRT monitors	20.48	8.86	38.90

Table 2 - NB-2 measurement results

Location	Mean (mG)	S.D. (mG)	Maximum (mG)
Bank card printing center	7.01	1.86	46.34
Office equipped fully with LCD monitors	1.33	0.44	11.45
Office above electric enclosure, equipped with LCD monitors	16.69	3.94	67.94

Table 3 - GIF measurement results

Location	Mean (mG)	S.D. (mG)	Maximum (mG)
Near Hardening and melting furnaces	952.75	186.19	6,149.30
Office inside the factory equipped fully with LCD monitors	12.37	2.13	45.17
Office behind electric enclosure inside the factory	111.61	21.85	424.32

Table 4 - ISCO measurement results

Location	Mean (mG)	S.D. (mG)	Maximum (mG)
Inside shelter (satellite control unit)	15.72	4.02	88.53
Satellite equipments maintenance service	56.94	11.75	195.53
Mobile broadcasting vehicle	25.37	6.41	126.59

Data collected in this study indicate that while doing the EMF risk evaluation in offices; some points should be considered.

The seating plan should be made by taking into consideration not only the technical specifications of the equipments used in the departments, but also the location of equipments like electric enclosures, high power lines. Staffs are generally not aware of the potential hazard unless the MFs produce an electromagnetic interference in sensitive electronic equipment (monitors, computers, audio/video equipment, etc.).

Although, the measured MF strengths of CRT (cathode ray tube) are higher than the LCD (Liquid Crystal Display) monitors, it is found that the exposure levels of a LCD monitor can be higher when an office is located near/above the electric enclosure.

Offices fully equipped with high-power electrical appliances should be shielded to reduce the MF exposure level.

For workers in telecommunication sector, risk evaluation should be done by considering both ELF and RF fields.

Due to the measurement conditions and results, it is strongly recommended that periodic EMF exposure measurements should be done to obtain more detailed understanding of workplace exposures and their sources, and workers/operators should be aware of EMF field-levels to protect their health. Training programmes about protection of workers from adverse health effects due to electromagnetic fields in view of scientific uncertainties are being carried out by GNRK due to the demand.

Results should be considered in the evaluation of risk assessment that would help to minimize the possibility of workers being harmed due to work-related electromagnetic sources. Thus, occupational exposure standards considering the precautionary principle relating to adverse health effects should promptly be legislated in Turkey and throughout the world.

Acknowledgement

EM Field measurements were performed with devices purchased from a grant from the Gazi University Research Foundation (Project No: 01/2003-62).

References

1. Villeneuve PJ, Agnew DA, Miller AB, *et al.* Leukemia in electric utility workers: the evaluation of alternative indices of exposure to 60 Hz electric and magnetic fields. *Am J Ind Med* 2000; 37(6): 607-17.
2. Wertheimer N, Leeper E. Electrical wiring configurations and childhood cancer. *Am J Epidemiol* 1979; 109(3): 273-84.
3. Milham S Jr. Mortality from leukemia in workers exposed to electrical and magnetic fields. (Letter). *N Engl J Med* 1982; 307(4): 249.

4. Savitz DA. Overview of occupational exposure to electric and magnetic fields and cancer: advancements in exposure assessment. *Environ Health Perspect* 1995; 103 Suppl 2: 69-74.
5. Willett EV, McKinney PA, Fear NT, *et al.* Occupational exposure to electromagnetic fields and acute leukemia: analysis of a case-control study. *Occup Environ Med* 2003; 60(8): 577-83.
6. Kheifets L, Sahl JD, Shimkhada R, *et al.* Developing policy in the face of uncertainty: interpreting 0.3 μ T or 0.4 μ T cutpoints from EMF epidemiologic studies. *Risk Anal* 2005; 25 (4): 927-35.
7. Deadman JE, Infante-Rivard C. Individual estimation of extremely low frequency magnetic fields in jobs commonly held by women. *Am J Epidemiol* 2002; 155(4): 368-78.
8. Gu  nel P, Nicolau J, Imbernon E, *et al.* Exposure to 50-Hz electric field and incidence of leukemia, brain tumors, and other cancers among French Electric Utility Workers. *Am J Epidemiol* 1996; 144(12): 1107-21.
9. Savitz DA, Cai J, van Wijngaarden E, *et al.* Case-Control Analysis of brain cancer and leukemia in electric utility workers using a refined magnetic field job-exposure matrix. *Am J Ind Med* 2000; 38(4): 417-25.
10. Kheifets L, Hester GL, Banerjee GL. The precautionary principle and EMF: implementation and evaluation. *J Risk Res* 2001; 4 (2): 113-25.
11. Hietanen M. *Electromagnetic Fields in the Work Environment*. Finnish Institute of Occupational Health Publication Office, 2002.
12. Foster KR, Erdreich LS, Moulder JE. Weak electromagnetic fields and cancer in the context of risk assessment. *Proc IEEE* 1997; 85: 733-46.
13. Seyhan N, G  ler G. Review of In Vivo Static and ELF Electric Fields Studies Performed at Gazi Biophysics Department. *Electromagn Biol Med* 2006; 25(4): 307-23.
14. Seyhan N, Canseven AG. In vivo effects of ELF MFs on collagen synthesis, free radical processes, natural antioxidant system, respiratory burst system, immune system activities, and electrolytes in the skin, plasma, spleen, lung, kidney, and brain tissues. *Electromagn Biol Med* 2006; 25(4): 291-305.
15. Seyhan N, Canseven AG, Guler G. Animal studies on the effects of ELF and Static EMF. *Bioelectromagnetics current concepts, NATO Security through Science Series B: Physics and Biophysics*. In Ayrapetyan SN, Markov MS, eds. *The mechanisms of the biological effect of extremely high power pulses*. Vol. 5. Netherlands: Springer Press, 2006; 195-212.
16. Sı rav B, Seyhan N. Radio frequency radiation (RFR) from radio antennas, 2003 IEEE International Symposium on Electromagnetic Compatibility – EMC. 2003; 2: 1232-6.
17. Firlarer A. Radiation exposure in medicine and industry – case studies. *Risk Evaluation Seminar in Occupational Health and Medicine*. Gazi University Medical Faculty. Ankara, 2007.
18. Firlarer A.,  am ST,  zden S, *et al.* Measurement results of high voltage lines ELF-MF fields: international approach, situation in Turkey and GNRK suggestions. 19th National Biophysics Congress. September 5-7, 2007, KONYA, Proceedings Book, S17.
19.  am ST, Seyhan N, Firlarer A, *et al.* EMF exposure survey in working environment located above or close to transformer stations and electric enclosures, Proceedings of 12th International Congress of the International Radiation Protection Association, October 19-24, 2008, Buenos Aires-Argentina.
20. GNRK EM Measurement and Consultancy Report, 2007. Report No: 2007–08/KT.004.
21. GNRK EM Measurement Report, 2007. Report No: 2007-11/KT.006.
22. GNRK EM Measurement and Consultancy Report, 2008. Report No: 2008-07/KT.008.
23. GNRK EM Measurement Report, 2008. Report No: 2008–08/KT.011.

Exposure to electromagnetic fields and human reproduction: the epidemiologic evidence

Irene Figà-Talamanca*, Paola Nardone*, Claudia Giliberti**

* University of Rome "La Sapienza", Rome, Italy

** National Institute for Prevention and Safety at Work, ISPESL, Rome, Italy

Abstract

Several studies have examined the reproductive effects of occupational and environmental exposures to electromagnetic fields (EMF) using *in vitro*, *in vivo* and epidemiologic methods. The present paper reviews the main results of the epidemiologic literature on the effects of exposure to EMF on male and female reproduction, indexed in the *PubMed* data bank after 1990. Studies on male reproductive effects have mainly focused on the possible association between occupational exposure to EMF and infertility or congenital defects in the offspring. Studies on possible female reproductive effects have examined the association between exposures during pregnancy to EMF (VDTs, residential exposure to ELF magnetic fields, electric blankets, heated water beds, mobile phones) and spontaneous abortion and congenital defects in the offspring. For each study, the authors paid particular attention to the study design (cohort, correlational, case-control, prospective follow-up, experimental), the population and outcomes studied, the method of exposure assessment to EMF and the results obtained. Overall, the results obtained to date through the epidemiological approach, do not raise strong concern for human reproductive health from the usual occupational and environmental EMF exposure levels. However there is also some evidence that subjects with unusually high exposures, show some increase in reproductive risk. In discussing the evidence the authors point out to numerous limitations of most epidemiologic studies: confounding factors such as age, smoking, occupational exposures to male and female reproductive chemical toxicants, sedentary life style etc. are often not taken into account. In addition, exposure of the subjects to EMF has been frequently determined only on the basis of interviews and self reports on the part of the subjects involved. These limitations are also discussed, together with the possible mechanisms of action of hypothesized/suspected reproductive effects of EMF on male and female reproduction as suggested by the literature of animal studies.

Key words: Electromagnetic fields, human reproduction, epidemiology

Address: Professor Irene Figà-Talamanca, Department of Public Health and Infectious Diseases, University of Roma "La Sapienza", Piazzale Aldo Moro 5, 00185 Rome, Italy
Tel. 0039 06 49912685 - Fax 0039 06 49912603 - E-mail: irene.figatalamanca@uniroma1.it

Introduction

Until relatively recent times, physical and chemical environmental pollutants were not considered a risk for the human reproductive health. Research in this area was prompted beginning with the decade of the 1970's and 80's, as a result of the massive entrance of women in the workforce, and the introduction of new technologies involving new risks for both the occupationally exposed and the general population.

Among the physical environmental risk factors, the non-ionizing radiations and in particular the electromagnetic fields (EMF), are the ones which have drawn the attention of most researchers. Early studies focused on male reproductive effects, finding possible effects on spermatogenesis and fertility, especially for workers exposed to microwaves and radar operators, where thermal effects are also possible. Among women, possible reproductive effects were examined in both occupational and environmental settings, by evaluating pregnancy outcomes (e.g. low birth weight of the newborn, foetal loss, congenital defects, etc.), in relation to work with video terminals (VDTs), to the use of electric blankets and bed heaters or to other domestic exposures during the gestational period.

Although several of the early studies have shown some increases in risk for human reproduction (both male and female), most studies were either negative or inconclusive, because of serious methodological limitations. The main problem in most studies has been the determination of the real exposure of the subjects to EMF. This is especially true of early studies, where exposure to EMF was determined only on the basis of self reports on the part of the subjects involved.

This is why, many researchers undertook experimental studies, where it is possible to evaluate with precision the type and doses of EMF administered to the animal, and the reproductive outcome expected, in predetermined gestational time windows.

The scientific literature on these topics has already been reviewed several times in the past^{1,2,3}. The present review offers an update in respect to previous reviews, and is based on studies selected on the basis of the following criteria: (1) studies published in journals indexed in the *PubMed* data bank after 1990; (2) studies where exposure to EMF was assessed by either a direct measurement in the living and work environment, or indirectly by an estimate based on predetermined parameters (e.g. vicinity to the emitting source, frequency and duration of contact etc.); (3) the hypotheses of the study were tested with appropriate statistical methods. The review also includes the studies on the possible role of EMF exposures through cellular phones, which have not been reviewed previously.

Epidemiologic studies on the effects of exposure to EMF on male reproduction

Exposure to EMF and male infertility

The possible role of EMF on male fertility was first suggested by Buiatti *et al.*⁴, who found an increased risk for infertility among radio and electricity workers compared to other occupations.

A study of welders, who are often exposed to EMF, also found poor semen quality, but this could also be attributed to exposures to metal fumes inhaled during welding⁵.

To identify the specific role of EMF, Lundsberg *et al.*⁶ undertook a case control study among 1,309 men attending the Yale New Haven Hospital Infertility Clinic. Exposure to

EMF, was ascertained by job title, classifying occupations in three groups (high, medium and low levels of exposure). The study found no difference in occupational exposures to EMF, among cases and controls in sperm morphology, concentration and motility (Table 1).

Military personnel is particularly exposed to radiofrequency EMF because of work in the vicinity of high frequency aeriels, communication equipment and radar. These groups were studied recently in Norway among 10,497 currently and formally employed military men⁷. Levels of exposure to EMF and male reproductive health (infertility, and involuntary childlessness), were ascertained by mailed questionnaires. Infertility (unsuccessful attempt to conceive for 12 months), was more common among the men working closer than 10 meters from high frequency aeriels, or to communication and radar equipment. The data showed a dose-response relationship, and the effect was statistically significant, and particularly evident for the men reporting “very high” exposures to radio frequencies. Similar results were obtained with the variable “involuntary childlessness”. In addition, in the highly exposed military men, the study found a statistically significant alteration of the sex ratio. The authors suggest that this may be due to a lowered ratio of testosterone/gonadotropin among men exposed to radiofrequency radiation.

In recent times, the concern about possible negative effects of EMF on health has shifted to the fast growing diffusion of mobile phones. Although most research deals with neurological and carcinogenic effects, there is also some evidence from studies of possible reproductive effects.

The first epidemiologic study on the possible relationship between cell phone use and semen quality was conducted in 2002-2004, among 372 men attending an infertility clinic in Hungary⁸. Exposure to cellular phones was examined in terms of duration of possession, duration of standby position closer than 50 cm to body (in hours), and duration of daily transmission (in minutes). The results showed no change in overall motility but a significant decrease in the proportion of rapid progressive motile sperm with increasing daily transmission time ($r=-0.19$; $p<0.01$). No change in overall motility was found in relationship to duration of possession, or to duration of standby position near the subject.

A subsequent study in Poland, conducted between 2004-06 among 304 men attending two infertility clinics⁹, found an association between frequent use of GSM phones and several poor semen quality parameters including percent viable and progressively motile sperm, and percent sperm with abnormal morphology.

A third similar study conducted in an infertility clinic of Cleveland Ohio, confirmed the same findings: men who never used cell phones had consistently better sperm parameter (in particular sperm count, motility, viability and morphology) than users of cell phones. The reduction in sperm quality followed a dose-response curve proportional to the duration of daily use¹⁰.

Unfortunately in most of these studies confounding factors such as age, smoking, occupational exposures to male reproductive toxicants, sedentary life stile etc. are not taken into account, making these results questionable. Nevertheless the consistency of these observations and evidence from experimental studies, raise a serious concern and call for further research to clarify this important question.

Paternal occupational exposures to EMF and congenital defects in the offspring

The exploratory large scale case-control study of Schnitzer *et al.*¹¹, examined the role of paternal occupation and the risk of congenital defects. The study was based on the Birth Defects Registry of Atlanta (USA) and the occupations of the fathers of both cases

Table 1 - Selected studies on male exposure to EMF and fertility

Type of study	Place / Time	Population and outcomes studied	Exposure Assessment to EMF	Results	Ref. N.
Nested case-Control	New Haven USA 1984-1987	Cases: Males of couples attending infertility clinic (n=1,309) presenting altered sperm morphology/concentration/motility. Controls: Males with normal sperm parameters	Occupational exposures to EMF on the basis of job titles and use of a job-exposure matrix.	Occupational exposures to EMF not associated with altered sperm morphology: OR= 0.7 (95% CI 0.2-1.8) Low sperm count: OR=1.0 (95% CI 0.4-2.5) Low motility : OR=1.3 (95% CI 0.6-2.9)	6
Case control	Norway 2002-2004	10,497 military men studied for infertility	Mailed questionnaires on exposures to EMF by working in the vicinity of: (1) High frequency aeriels (2) communic. equipment (3) radar.	Statistically increased ORs for infertility in all groups and in all age groups, with a dose-response relationship.	7
Corre-lational	Hungary 2002-2004	A total of 372 men attending an infertility clinic for the evaluation of semen parameters.	Interview on duration of cellphone possession (months), of standby (hours) of transmission (minutes)	Reduction of % spermatozoa reduced motility was associated with longer daily transmission time. No effect was observed in association with length of possession and daily standby.	8
Corre-lational	Poland 2004-2006	A total of 304 males attending two infertility clinics for semen quality evaluation. Divided into 4 groups according to their sperm motility and morphology.	Interview on the frequency of use of GSM cellular phones	An association was found between frequency of use of GSM phones and reduced sperm viability and motility (p<0.001), and altered morphology (p<0.001)	9
Corre-lational	Cleveland Ohio 2004-2005	A total of 361 males attending an infertility clinic for semen quality evaluation, divided into 4 groups according to the intensity of use of cell phones.	Exposure to EMF through self reported daily duration of cell phone use	Increased risk for reduction in sperm count (p<0.05), reduction in percent motile sperm (p<0.05), reduction in percent viable sperm (p<0.05), reduction in percent normal sperm (p<0.05) for the more exposed groups.	10

(n= 3,905) and controls (n=2,388) were ascertained by telephone interview. The data showed an increased risk for several congenital defects among the offspring of electricians and electrical workers, (coartation of the aorta) and among electronic equipment operators (reduction defects of upper limbs). The occupations in this last category, included air traffic controllers, broadcast equipment and telephone operators, all potentially exposed to EMF. Although only “exploratory”, these observations prompted further research among males professionally exposed to EMF in relation to birth defects in the offspring, as well as other reproductive outcomes.

The Norwegian Birth Registry for example, containing data on birth defects, linked to the census data, containing information on the occupation of the father, was used to test the hypothesis further. An expert panel classified occupations according to their potential exposures to EMF. The analysis involved 541,593 births, and included 24,885 fathers with “probable” exposure to EMF. With a case-control design, the authors compared the risk of having an exposed father of the 15,132 cases of congenital defects with the healthy controls. No association was found, with the exception of the cases of “other defects” showing an increase in risk among fathers with “possible” exposure to radiofrequencies. This group comprised only 16 heterogeneous cases of birth defects, and the result is not considered noteworthy. This study also found an association between paternal exposure to EMF and preterm delivery but no association with low birth weight (LBW), or stillbirth¹² (Table 2).

Overall, the data available to date on the possible reproductive effects of EMF on males do not provide evidence of a causative association between paternal exposure and effects on the offspring. On the contrary, the emerging evidence on the possible role of

Table 2 - Selected Studies on Male Exposures to EMF and Effects on the Offspring

Type of study	Place / Time	Population and outcomes studied	Exposure Assessment to EMF	Results	Ref. N.
Case-control	Atlanta USA 1968-1980	Cases: Birth defects from Registry (n=3,905) Controls: Matched from Birth Registry (n=2,388)	Paternal job titles obtained by telephone interviews	Increased risk for coartation in the offspring for electrical workers (OR 3.0=(95% CI 1.2-7.5) Increased risk for reduction of upper limbs OR 4.2 (95% CI 1.3-13.7)in the offspring of electronic equipment operators.	11
Case control	Norway 1967-1998	Cases: congenital defects, preterm deliveries, cases of LBW and stillbirths obtained in the Medical Birth Registry Controls: all normal newborns in the same period of time.	Classification of Paternal Occupations as “probable”, “possible” and “none” for exposures to Radiofrequencies by a blind expert panel.	No increase in risk of congenital defects, Increased risk of preterm delivery OR=1.08 (95%CI 1.03-1.15) No increase in risk of LBW and still birth.	12

EMF and infertility is of interest, particularly for what concerns the use of cellular phones. As shown above (Table 1), three different studies with similar methodologies showed similar results: a statistically significant inverse correlation between intensity of cell phone use and altered spermatic parameters.

Epidemiologic studies on the effects of exposure to EMF on female reproduction

The issue of the possible role of VDTs on pregnancy exploded 20 years ago, with the wide use of terminals by working women. Early reports by North American mass media on the possible role of VDTs in several clusters of miscarriages and birth defects¹³ stimulated a large number of studies. Most of these studies examined spontaneous abortion and birth defects in occupational settings with heavy use of VDTs and in connection with the use of domestic and residential exposures.

Studies of the role of EMF in spontaneous abortion

The evidence up to the year 2000, concerning spontaneous abortion, has thoroughly reviewed by Shaw¹⁴. Of the 13 different studies conducted since 1982, only one found a statistically significant increase in the risk of spontaneous abortion among exposed women (RR= 1.8). In others, the increase in risk was modest (ranging from 1.1 to 1.2) and not statistically significant. Table 3 summarizes the studies published after 1990.

In the study by Schnorr *et al.*¹⁵, a cohort of 4246 women working with VDTs was compared to cohort of women who never used VDTs. The exposure to EMF was measured in a sample of workstations, while data on pregnancy outcomes were collected by telephone interviews. No association was found between the exposure to EMF through use of VDTs and the risk of spontaneous abortion.

Another series of studies examined the risk of early pregnancy loss (EPL) with residential exposure to ELF magnetic fields. Juutilainen *et al.*¹⁶ undertook a case control study among 89 cases of women with miscarriage of the first pregnancy and 102 controls among women with normal first pregnancies. The cases and controls were obtained from the data of the Work and Fertility project, and the exposure of each case and control was ascertained by measurements of ELF magnetic fields in various locations of their home. The results show no association between spontaneous abortion and EMF exposure except for women exposed to high-intensity residential magnetic fields (over 50 Hz) (8 cases and 2 controls). For this group the OR was 5.9 (95% CI 1.0-26).

A prospective study of Belanger *et al.*¹⁷ also considered the possible risk of spontaneous abortion in the use of electric blankets, heated water beds and home wire codes. About 3000 pregnant women attending prenatal care clinics were interviewed on the use of electric blankets and electric heaters during pregnancy. In the follow up, 135 of them reported a miscarriage. Exposure was estimated on the basis of use (duration, frequency, temperature set etc.) of electric blankets and heaters water beds. This study did not support the hypothesis that use of electric heated beds increases the risk of spontaneous abortion. Electric blanket use at the time of conception and in early pregnancy may be associated with a slight increase risk of pregnancy loss, but this association was not confirmed after adjustment for confounding variables. Home electric wire codes also showed no association with spontaneous abortion.

Table 3 - Studies of the role of EMF in spontaneous abortion

Type of study	Place / Time	Population and outcomes studied	Exposure Assessment to EMF	Results	Ref. N.
Cohort study	USA (1983-1986)	4246 women aged 18-33 years who used VDTs at work was compared to cohort study of non-VDTs uses for incidence of spontaneous abortions.	A telephone interview was used to collect lifetime reproductive histories and the exposure to electromagnetic fields was measured at VDTs workstation.	No increase in risk of spontaneous abortion among women who used VDTs: OR 0.93 (95% CI 0.63-1.38)	15
Case-control study	Finland (1984-1986)	89 cases of women with miscarriage; 102 controls of women with term births	Residential exposure to EMF of 50 Hz: Professional exposure based on the type of work and measurements of EMF of 50 Hz.	No association found except for residential exposure (front door measurements of 0.5 A/m and over) OR: 5.09 (95% CI 1.06-26) No association found for professional exposures.	16
Cohort study	Connecticut (1988-1991)	2967 pregnant women attending prenatal care clinics with 135 miscarriages	Home interview on use of electric blankets and electric bed heaters during pregnancy. Evaluation of home wire codes.	No increase in risk for women using electric blankets at conception OR: 1.74 (95% CI 0.96-3.15) or at interview OR: 1.61 (95% CI 0.81-3.19). No increase in risk for women using daily electric bed at conception: OR 0.90 (95% CI 0.56-1.46) At interview: OR: 1.54 (95% CI 0.68-3.46) No increase in relation to type of wire codes.	17
Cohort study	California (1990-1991)	A cohort of 5342 pregnant women with 499 spontaneous abortion autocomes.	Exposures to EMF during the first trimester of pregnancy estimated by use of electric blankets and bed heaters as reported by subject.	No increase in risk for women using electric blanket OR: 0.8 (95% CI 0.6-1.2). No increase in risk for women using electric bed heaters OR: 0.9 (95% CI 0.7-1.1)	18
Cohort study	San Francisco (California) (1996-1998)	969 pregnant women attending a prenatal clinic, Followed for pregnancy outcome.	Measured through a personal measuring device for 24 hrs of a "typical day".	Increase in risk observed only for women exposed to a maximum daily dose of ≥ 16 mG: RR 1.8 (95% CI 1.2-2.7) The increased risk concerned particularly those exposed in the early period of gestation (0-9 weeks): RR: 2.2 (95% CI 1.2-4.0) and the women with previous miscarriages: RR: 3.1 (95% CI 1.3-7.7)	19

Lee and collaborators¹⁸ also conducted a prospective cohort study to evaluate the relation of spontaneous abortion and electric blankets and bed heater use during the first trimester of pregnancy. A cohort of about 5342 pregnant women were interviewed by telephone between 4 and 13 weeks of gestation. Exposure to EMF was estimated by measuring the emissions in four types of conventional blankets used by the majority of the women, taking into account duration and frequency of use. This study was negative too. No association was found between use of electric blankets and electric bed heaters use and spontaneous abortion.

The only study showing an increased risk for spontaneous abortion in association with exposure to relatively elevated doses of EMF during pregnancy is a cohort study by Li *et al.*¹⁹. This is also the only study in which exposure was measured on the individual level among pregnant women by a personal dosimeter in a “typical day”. The results show an increase in risk for miscarriage for the pregnant women with a total sum exposure or a maximum exposure higher than 16 mG. The effect was more pronounced for the women whose exposure occurred in the first nine weeks of gestation (OR 5.7, 95% CI 2.1-15.7).

In general, it might be concluded that, with few exceptions, the evidence on a possible cause-effect association between exposures of pregnant women to EMF emissions from the usual electrical appliances (VDTs, electric bed heaters and blankets, usual wire codes etc.) is either absent or weak. At the same time it should be noted that the majority of studies did not succeed in determining the true exposure of the pregnant women, and none obtained objective exposure measurements during the critical gestational periods. This is a particularly difficult task in epidemiology and it probably explains the absence of new recent studies on this issue.

Exposure to EMF in pregnancy and congenital defects in the offspring

The studies on this topic are summarized in Table 4.

A prospective follow-up study of Milunsky *et al.*²⁰ was designed to determine if exposure to hot tub, sauna or electric blankets during pregnancy was associated with an increased risk for neural tube defects (NTDs). This study is part of large investigation of pregnancy outcomes in a cohort of 23491 women receiving prenatal care, identified through 100 participating obstetricians. Data were collected by personal interview or by telephone and included questions regarding family, medical and genetic history, information about diet and on exposure to different risk factors. No association was found between the exposure to electric blanket use and the risk of congenital defects; however the heat in the form of hot tub or sauna in the first trimester of pregnancy was associated with an increased risk for NTDs; indeed the OR for hot tubs is 2,8 (CI 95% 1,2-6,5).

A similar result was reached by a study of Dlugosz *et al.*²¹ that also considered the possible risk of congenital defects in the use of electric blanket and heated waterbeds. Cases of newborns with cleft palate, cleft lip, (with or without cleft palate) and anencephalus and spina bifida were identified from the New York State congenital malformation Registry. Controls were selected at random from the birth registry. Information on periconceptional electric blanket and heated waterbed use, as well as known and suspected risk factors for these defects, was obtained from questionnaires mailed to the mothers. The results suggest that EFMs do not cause neural tube and oral cleft defects.

Another study examined the risk of congenital urinary tract anomalies among offspring of women with a history of subfertility and the use of electric blanket during

pregnancy²². For this study 118 cases of congenital urinary tract anomalies (CUTA) born in Washington in 1990-1991 were recruited. Healthy controls (369) were randomly selected in the same place and time. Exposure to electric blankets, water beds and VDTs in pregnancy was obtained with structured interviews with the mother within the third year of life of the child. The data show that exposure to electric blankets does not increase risk for CUTA (OR: 1.1- 95% CI 0.5-2.3). However the results show an increased risk for CUTA for subfertile women exposed to electric blankets during the first trimester of pregnancy (n= 6 cases): OR 10.0 (95% CI 1.2-85.5).

Robert *et al.*²³ also conducted a case-control study to determine whether living closer to high voltage power lines (HPLV) increased the risk of congenital anomalies. This study recruited 151 cases of children with various congenital defects living in municipalities with high voltage power lines (HPLV) and 302 healthy children from the same municipality. The distances of cases and controls from the HPLV were used to classify exposed and non exposed. These data indicated no association between distance from HPLV and the total number of congenital anomalies.

Another case-control study, also based on the distance from power lines, was conducted by Blaasaas²⁴. Two controls matched for sex, year of birth, and municipality were selected randomly for children with various birth defects. The distances between maternal addresses during pregnancy and power lines were obtained from maps. The magnetic fields in the residences were estimated based on distance, current, voltage, and wire configuration. Also this study does not support the hypothesis that residential exposure to EMF from power lines causes any of the investigated outcomes.

Two population-based case-control studies of Shaw *et al.*²⁵ considered the possible risk of congenital malformations (neural tube defects and orofacial cleft) and the use of electric bed-heating devices. Information on bed-heating was obtained from 538 NTD cases and their 539 controls in one study, and 265 NTD cases and 481 controls and 652 orofacial cleft cases and their 734 controls from another study. The exposure of each case and controls was ascertained by interview with mothers within 3-8 years after birth on frequency of use of electric blankets and waterbeds during pregnancy. The results revealed a few modestly elevated risks associated with maternal use of bed-heating devices; indeed the OR for cleft lip with or without cleft palate associated with maternal periconceptual use of electrically heated bed devices is 1.8 (95% CI 1.0-3.2).

In a study of Blaasaas *et al.*²⁶ the risk of birth defects with parental occupational exposure to 50 Hz EMF was examined. This study shows that there is no association between the total risk of birth defects and parental exposure; however maternal exposure was associated with increased risks of spina bifida (p= 0.04) and clubfoot (p=0.04). Paternal exposure was associated with increased risk of anencephaly (p=0.01) (Table 4).

Use of mobile phones during pregnancy

Three epidemiological studies examined the effects of maternal exposure to cell phones on prenatal, neonatal and child health (Table 5). A Swedish cohort study²⁷ examined the association between prenatal and postnatal exposure to cell phones and behavioural problems in young children. A total of 101032 pregnancies were enrolled in the cohort. The protocol included four telephone interviews: two were conducted during pregnancy and the last two when the newborn children reached six and eighteen months of age. The highest odds ratios for behavioural problems were observed for children who

Table 4 - Exposure to EMF and congenital defects

Type of study	Place / Time	Population and outcomes studied	Exposure Assessment to EMF	Results	Ref. N.
Prospective follow-up study	New England (1990)	A cohort of 23491 newborns of women recruited through 100 participating obstetricians. A total of 49 pregnancies ended with an NTD.	Trained nurse interviewers contacted the women by telephone and asked questions regarding family, medical and genetic history, and exposures to EMF, hot tubs and saunas.	No increased risk for infant with NTD for women exposed to electric blankets during pregnancy OR: 1.2 (95% CI 0.5-2.6) Exposure to hot tub, in the first trimester of pregnancy, was associated with a increased risk for NTDs: OR 2.8 (95% CI 1.2-6.5)	20
Case-control study	New York (1988-1989)	663 cases of newborns with cleft palate, cleft lip, neural tube defects born in New York state in 1988-1989 and 685 randomly selected controls born in the same state and time.	Mail questionnaires on use of electric blankets and heated waterbeds in periconceptional period.	No increased in risk for all the examined congenital defects and exposure to electric blankets use: OR 0.99 (95% CI 0.49-1.57) Exposure to heated waterbed use: OR 1.08 (95% CI 0.63-1.86).	21
Case-control study	Washington State (1990-1991)	118 cases of congenital urinary tract anomalies (CUTA) born in Washington in 1990-1991 and 369 healthy controls randomly selected in the same place and time.	Exposure to electric blankets, water beds, and VDTs in pregnancy obtained with structured interview with the mother within the 3 ^o year of life of the child.	No increased risk for CUTA for exposure to electric blankets: OR 1.1 (95% CI 0.5-2.3); waterbed: OR 1.2 (95% CI 0.6-2.2). Increased risk for CUTA for subfertile women exposed to electric blanket during the first trimester of pregnancy (n=6) OR: 10.0 (95% CI 1.2-85.5).	22
Case-control study	France (1988-1991)	151 cases of children with various congenital defects living in municipalites with high voltage power lines (HPLV) and 302 healthy children from the same municipality.	Distances of residence of cases and controls from the HPLV (less than and more then 100 metres) were used to classify exposed and non exposed cases and controls.	No increase in risk of congenital defects and distance of ≤ 100 m from HPLV OR: 0.95 (95% CI 0.45-2.03) ≥ 50 m from HPLV OR: 1.25 (95% CI 0.49-3.22). 23	23

(continued)

Table 4 - Exposure to EMF and congenital defects

Type of study	Place / Time	Population and outcomes studied	Exposure Assessment to EMF	Results	Ref. N.
Nested case-control study	Norway (1986-1997)	Children born with various birth defects obtained from the birth defects registry of Norway. 465 cases and 930 controls.	Two controls matched for sex, year of birth, and municipality were selected randomly for children with birth defects. The distances between maternal addresses, during pregnancy, and power lines were obtained from maps mainly. The magnetic fields in the residences were estimated based on distance, current, voltage, and wire configuration.	No increase in risk: hydrocephalus OR 1.73 (95% CI 0.26-11.64) Cardiac defects OR 1.54 (95% CI 0.89-2.68)	24
Case-control study	California (1989-1991) (1987-1988)	Study 1: 538 cases newborns with NTDs identified in the California Birth registry and 539 randomly selected controls. Study 2: 265 NTD cases and 481 controls, and 652 orofacial cleft cases and 734 healthy controls randomly selected from the same birth registry.	Interview with mothers of cases and controls within 3-8 years after birth on frequency use of electric blankets, waterbeds during pregnancy.	No increased risk among daily users of electric blankets OR: 1.3 (95% CI 0.5-3.4) Increased in risk of orofacial clefts among users of heated waterbed OR: 1.8 (95% CI 1.0-3.2) No increased risk for NTDs associated with users of electric blankets.	25
Study of linkage of records	Norway (1967-1995)	About 240000 children born with various birth defects obtained from the birth defects registry of Norway (period 1967-1993)	The medical birth registry of Norway was linked with census data on parental occupation. An expert panel constructed a job exposure matrix of parental occupational exposure to 50 Hz magnetic fields.	Maternal exposure was associated with increased risks of spina bifida (p= 0.04) and clubfoot (p=0.04) Paternal exposure was associated with increased risk of anencephaly (p= 0.01)	26

had both prenatal and postnatal exposure to cell phones compared with those who were not exposed during either time period. For these children the adjusted OR for the overall behavioural score was 1.80 (95% CI = 1.45–2.23). For prenatal or postnatal exposure only, the adjusted OR were 1.54 (1.32–1.81) and 1.18 (1.01–1.38), respectively. For the combined prenatal and postnatal exposure, the ORs were higher for prenatal exposure than for postnatal exposure, for each of the behavioural problems.

Table 5 - Studies on the effects of the exposure to cellular phones during pregnancy

Type of study	Place / Time	Population and outcomes studied	Exposure Assessment to EMF	Results	Ref. N.
Cohort study	Sweden (2005-2006)	A total of 101032 pregnancies were enrolled in the cohort. Mothers and live born children constitute two fixed cohorts to be followed for decades in a life-course perspective.	4 telephone interviews: 2 were conducted during pregnancy and 2 when the newborn child reached 6 and 18 months of age. A new round of mail questionnaire were conducted when the children reached the age of 7 years.	The highest OR for behavioural problems were observed for children who had both prenatal and postnatal exposure to cell phones. For these children the OR for prenatal exposure was 1.54 (95% CI 1.32-1.81) and the OR for postnatal exposure was 1.18 (95% CI 1.01-1.38).	27
Experimental study	Cairo-Egypt (2003-2004)	90 women with uncomplicated pregnancies aged 18-33 years, and 30 full term healthy newborn infants were included. The main outcome measurements were neonatal HR (neonatal heart rate) and cardiac output (COP).	The pregnant mothers were exposed to EMF emitted by mobile telephones while on telephone dialing mode for 10 minutes during pregnancy and after birth.	A statistically significant increase in foetal and neonatal HR, and statistically significant decrease in stroke volume and COP before and after use of mobile phone were noted. All these changes are attenuated with increasing gestational age. COP: p-value <0.025 HR: p-value < 0.011	28
Experimental study	Turkey	40 volunteers with uncomplicated pregnancies recruited to study the effects of cellular phone use in foetal heart rate	All patients were exposed to EMF for 10 minutes. The FHR-analysis was based on the description of heart patterns.	Results indicate that EMF emitted by cellular phone do not cause any demonstrable effects on baseline FHR. p-value: 0.394	29

Another study²⁸ investigated foetal and neonatal heart rate (HR) and cardiac output (COP), following maternal exposure to EMF emitted by mobile phones. Ninety women with uncomplicated pregnancies aged 18-33 years, and 30 full term healthy newborn infants were included. The pregnant mothers were exposed to EMF emitted by mobile telephones while on telephone-dialing mode for 10 minutes several times during pregnancy and after their parturition. A statistically significant increase in foetal HR (p-value <0.011), and statistically significant decrease in stroke volume and COP (p-value <0.025) before and after use of mobile phone were noted. All these changes were attenuated with increasing gestational age.

A previous experimental study planned to determine the effects of EMF produced by cellular phones on baseline foetal heart rate (FHR), acceleration and deceleration however did not show such effects. Forty volunteers with uncomplicated pregnancies were exposed once to EMF for 10 min. The results show that EMF emitted by the cellular phones do not cause any demonstrable effects on baseline FHR, acceleration or deceleration²⁹. The question of the effects of intensive use of cell phones on foetal physiology is therefore not settled.

Possible mechanisms of action of EMF on male and female reproduction

From the above review, it appears that most epidemiologic studies do not raise strong concern for human reproductive health from present day occupational and environmental EMF exposure levels. However there is also some evidence that subjects with unusually high exposures, do show some increase in reproductive risk. What are the mechanisms of action hypothesized/suspected that could explain the reproductive effects?

The voluminous literature of animal studies is certainly a source of information and hypothesis generation in this sense.

The mechanisms of action would of course be different for males and females, although the effect could be manifested in the outcome of the pregnancy of unexposed females mated with exposed males. Most experimental studies however have focused on the reproductive effects on either male or pregnant female animals although some reports concern the effects on the male progeny exposed during the intrauterine life.

Studies on the effects of 50 Hz fields on the fertility of male mice, have not shown consistent results³. One study for example showed that early life exposure of mice resulted in a significant increase of testis size, but no effect was detected in their spermatogenesis³⁰, while another study found a slight spermatid morphological effect³¹. However germ cell apoptosis in the testis and decreased spermatogenesis was observed of mice after an eight week 24/h a day exposure to 60 EMF of 0.1 mT or 0.5 mT³². In addition, a recent report indicates that exposure of rats to EMF (50 Hz) *in utero* as well as in postnatal period has a deleterious effect in their prostate gland³³. There is also some suggestive experimental evidence about the possible male effects of radiofrequency electromagnetic fields. Adult rats exposed to 900 MHz showed a decrease in their germinal epithelium³⁴.

The animal studies therefore provide evidence of possible damage of the male reproductive system at doses similar to those encountered in our environment. These studies also allow to generate hypotheses about the possible mechanism of action of EMF on the endocrine and reproductive system. There are several such hypotheses.

One hypothesis is based in the observation that EMF effect the state of *polarisation of cell membranes*. Membrane polarisation is a critical determinant both in spermatogenesis and in sperm cell enabling to penetrate into the egg cell. Secondly, electromagnetic radiation has both thermal and non thermal effects on living cells. Prolonged exposure to high temperatures in some male occupational groups for example, has been shown to damage sperm quality^{35,36}. However the thermal effect is unlikely to be the case of exposure to RF (as in the case of cell phones), which have a specific absorption rate (SAR) ranging between 0.1-2 W/kg, and use a radiofrequencies below the safety levels. In addition, at least one experimental study did not find a thermal effect of cell phones on the testis of laboratory animals³⁷.

The alternative hypothesis proposed by most authors attributes the effect to *alterations* in the *hormonal equilibrium*. This effect, which might be relevant for both males and females exposed to EMF, is hypothesised to be mediated through the suppression of melatonin with consequent rise in estrogen levels and disruption of the hormonal balance¹⁴.

The possible role of hormonal interference is confirmed by the study of Farkhad³⁸ which showed that exposure of male Guinea Pigs to Extremely Low Frequencies Magnetic Fields (ELF MFs) resulted in a significant reduction in testosterone levels accompanied by histological alterations of the testis such as atrophy of the seminiferous tubes and reduction of Leydig cells.

Animal studies on pregnant females exposed to ELF MFs have also repeatedly shown negative effects on the foetus, including increase in mortality, reduced litter size and LBW³⁹. Several studies administering doses similar to those created by standard VDTs (of the order of 20 and 50 kHz and intensities of 10 mG) also found an increased risk of congenital defects (especially skeletal variations and malformations)^{40,41}.

Studies on non mammalian species too show negative reproductive outcomes of treated animals. Exposing chick embryos to VTDs during embryonic and postembryonic phase has been shown in several studies to increase mortality and to effect the normal development but these effects have not been confirmed in all studies⁴².

About the induction of effects of radiofrequency (RF 100 kHz-300 GHz) on prenatal development, experimental studies indicate that teratogenic effects can occur only from exposure levels that cause biologically detrimental increases in maternal body temperature⁴³.

There are therefore still uncertainties about the possible mechanism of action of ELF MFs on the mammalian female reproductive function even in experimental studies. One hypothesis, tested in mouse cultured developing follicles exposed to 33 Hz *in vitro*, suggests *interference with follicular maturation*⁴⁴. Another hypothesis, based on the treatment of the ultrastructure observation of the ovaries and uterus of rats exposed to 50 Hz 1mT ELF MFs, suggests that the reproductive damage may be attributed to *cytological alterations* in the germinal epithelial cells and in reduction in the cell organelles of the ovaries and the uterus⁴⁵.

As concluded by Saunders⁴⁶ at present there is no accepted mechanism for biological effects of EMF on reproduction. In general, the development of mammalian species through the prenatal period is characterized by a highly ordered sequence of processes as cell proliferation, differentiation, migration and programmed cell death (apoptosis), that could be susceptible to a variety of environmental agents. Theory suggests that cells contain their own weak electric signals, by which cells communicate with each other, that is the way by which the body is able to function, maintaining normal health⁴⁷. In addition, there is growing evidence that the endogenous currents have a role in guiding developmental processes, including cell orientation and migration, by establishing electrical potential gradients. These voltage gradients can possibly be affected by any exposure to EFMs, disrupting the communication sequences between the cells, that could adversely influence the prenatal development. Studies show that this effect occurs for the development of more susceptible species (ex. birds, and some laboratory animals), but, as discussed in the preceding paragraph, may well do so also in some mammalian embryos⁴⁶.

The lack of consistency of the experimental studies contributes to increase the difficulties in interpreting the epidemiologic literature.

On the whole, it might be said that most epidemiologic studies todate have provided reassuring results on the issue of the risks of EMF and human reproduction. In studies where such an association was found, the result is often limited to a particular subgroup of the individuals examined, and in general the increase in risk is low and could be attributed to some methodological limitation or bias.

What is still missing from both the epidemiologic and experimental literature, is humans evidence about long term effects on human (and animals) with early (prenatal and postnatal) exposures to ELF and RF MFs.

The ever increasing exposure of human populations to the new sources of ELF and RF emissions in early life, is an on going massive experiment, the results of which will be known in future years.

References

1. Brent RL, Gordon WE, Bennett WR, *et al.* Reproductive and teratologic effects of electromagnetic fields. *Reprod Toxicol* 1993; 7(6): 535-80.
2. Huuskonen H, Lindbohm ML, Juutilainen J. Teratogenic and reproductive effects of low-frequency magnetic fields. *Mutat Res* 1998; 410(2): 167-83.
3. WHO Environmental Health Criteria Monograph N. 238. Extremely Low Frequencies Fields. 2007
4. Buiatti E, Barchielli A, Geddes M, *et al.* Risk factors in male infertility: a case-control study. *Arch Environ Health* 1984; 39(4): 266-70.
5. Mortensen JT. Risk for reduced sperm quality among metal workers, with special reference to welders. *Scand J Work Environ Health* 1988; 14(1): 27-30.
6. Lundsberg LS, Bracken MB, Belanger K. Occupationally related magnetic field exposure and male subfertility. *Fertil Steril* 1995; 63(2): 384-91.
7. Baste V, Riise T, Moen BE. Radiofrequency electromagnetic fields; male infertility and sex ratio of offspring. *Eur J Epidemiol* 2008; 23(5): 369-77.
8. Fejes I, Závaczki Z, Szöllosi J, *et al.* Is there a relationship between cell phone use and semen quality? *Arch Androl* 2005; 51(5): 385-93.
9. Wdowiak A, Wdowiak L, Wiktor H. Evaluation of the effect of using mobile phones on male fertility. *Ann Agric Environ Med* 2007; 14(1): 169-72.
10. Agarwal A, Deepinder F, Sharma RK, *et al.* Effect of cell phone usage on semen analysis in men attending infertility clinic: an observational study. *Fertil Steril* 2008; 89(1): 124-8.
11. Schnitzer PG, Olshan AF, Erickson JD. Paternal occupation and risk of birth defects in offspring. *Epidemiology* 1995; 6(6): 577-83.
12. Mjøen G, Saetre DO, Lie RT, *et al.* Paternal occupational exposure to radiofrequency electromagnetic fields and risk of adverse pregnancy outcome. *Eur J Epidemiol* 2006; 21(7): 529-35.
13. Robert E. Intrauterine effects of electromagnetic fields – (low frequency, mid-frequency RF, and microwave): review of epidemiologic studies. *Teratology* 1999; 59(4): 292-8.
14. Shaw GM. Adverse human reproductive outcomes and electromagnetic fields: a brief summary of the epidemiologic literature. *Bioelectromagnetics* 2001; Suppl. 5: S5-18.
15. Schnorr TM, Grajewski BA, Hornung RW, *et al.* Video display terminals and the risk of spontaneous abortion. *N Engl J Med* 1991; 324(11): 727-33.
16. Juutilainen J, Matilainen P, Saarikoski S, *et al.* Early pregnancy loss and exposure to 50-Hz magnetic fields. *Bioelectromagnetic* 1993; 14(3): 229-36.
17. Belanger K, Leaderer B, Hellenbrand K, *et al.* Spontaneous abortion and exposure to electric blankets and heated water beds. *Epidemiology* 1998; 9(1): 36-42.
18. Lee G, Neutra R, Hristova L, *et al.* The use of electric bed heaters and the risk of clinically recognized spontaneous abortion. *Epidemiology* 2000; 11(4): 406-15.
19. Li DK, Odouli R, Wi S, *et al.* A population-based prospective cohort study of personal exposure to magnetic fields during pregnancy and the risk of miscarriage. *Epidemiology* 2002; 13(1): 9-20.
20. Milunsky A, Ulcickas M, Rothman KJ, *et al.* Maternal heat exposure and neural tube defects. *JAMA* 1992; 268: 882-5.

21. Dlugosz L, Vena J, Byers T, *et al.* Congenital defects and electric bed heating in New York state: a register based control study. *Am J Epidemiol* 1992; 135: 1000-11.
22. Li DK, Checkoway H, Mueller BA. Electric blanket use during pregnancy in relation to the risk of congenital urinary tract anomalies among women with a history of subfertility. *Epidemiology* 1995; 6(5): 485-9.
23. Robert E, Harris JA, Robert O, *et al.* Case-control study on maternal residential proximity to high voltage power lines and congenital anomalies in France. *Paediatr Perinat Epidemiol* 1996; 10(1): 32-8.
24. Blaasaas KG, Tynes T, Lie RT. Risk of selected birth defects by maternal residence close to power lines during pregnancy. *Occup Environ Med* 2004; 61(6): 559.
25. Shaw GM, Nelson V, Todoroff K, *et al.* Maternal periconceptional use of electric bed-heating devices and risk for neural tube defects and orofacial clefts. *Teratology* 1999; 60(3): 124-9.
26. Blaasaas KG, Tynes T, Irgens A, *et al.* Risk of birth defects by parental occupational exposure to 50 Hz electromagnetic fields: a population based study. *Occup Environ Med* 2002; 59(2): 92-7.
27. Divan HA, Kheifets L, Obel C, *et al.* Prenatal and postnatal exposure to cell phone use and behavioral problems in children. *Epidemiology* 2008; 19(4): 523-9.
28. Rezk AY, Abdulqawi K, Mustafa RM, *et al.* Fetal and neonatal responses following maternal exposure to mobile phones. *Saudi Med J* 2008; 29(2): 218-23.
29. Celik O, Hascalik S. Effect of electromagnetic field emitted by cellular phones on foetal heart rate patterns. *Eur J Obstet Gynecol Reprod Biol* 2004; 112(1): 55-6.
30. Picazo ML, De Miguel MP, Leyton V, *et al.* Long-term effects of ELF magnetic fields on the mouse testis and serum testosterone levels. *Electro Magnetobiol* 1995; 14(2): 127-34.
31. De Vita R, Cavallo D, Raganella L, *et al.* Effects of 50 Hz magnetic fields on mouse spermatogenesis monitored by flow cytometric analysis. *Bioelectromagnetics* 1995; 16(5): 330-4.
32. Lee JS, Ahn SS, Jung KC, *et al.* Effects of 60 Hz electromagnetic field exposure on testicular germ cell apoptosis in mice. *Asian J Androl* 2004; 6: 29-34.
33. Khaki AA, Khaki A, Garachurlou S, *et al.* Pre and post natal exposure of 50 Hz electromagnetic fields on prostate glands of rats: an electron microscopy study. *Iranian Journal of Reproductive Medicine* 2008; 6 (2): 77-82.
34. Ozguner M, Koyu A, Cesur G, *et al.* Biological and morphological effects on the reproductive organ of rats after exposure to electromagnetic field. *Saudi Med J* 2005; 26(3): 405-10.
35. Figà-Talamanca I, Dell'Orco V, Pupi A, *et al.* Fertility and semen quality of workers exposed to high temperatures in the ceramics industry. *Reprod Toxicol* 1992a; 6(6): 517-23.
36. Figà-Talamanca I, Dondero F, Gandini L, *et al.* Male infertility and occupational exposures. A case-control study. *J Occ Med and Toxicol* 1992b; 1(3): 255-65.
37. Dasdag S, Zulkuf Akdag M, Aksen F, *et al.* Whole body exposure of rats to microwaves emitted from a cell phone does not affect the testes. *Bioelectromagnetics* 2003; 24(3): 182-8.
38. Farkhad SA, Zare S, Hayatgeibi H, *et al.* Effects of extremely low frequency electromagnetic fields on testes in guinea pig. *Pak J Biol Sci* 2007; 10 (24): 4519-22.
39. Svedenstal BM, Johanson KJ. Fetal loss in mice exposed to magnetic fields during early pregnancy. *Bioelectromagnetics* 1995; 16: 284-9.
40. Huuskonen H, Juutilainen J, Julkunen A, *et al.* Effects of low-frequency magnetic fields on fetal development in CBA/Ca Mice. *Bioelectromagnetics* 1998; 19: 477-85.
41. Hassa H, Yalcin O, Basmak N, *et al.* Teratogenic effects of electromagnetic fields on the skeletal systems of rat fetuses. *Tr J of Medical Sciences*. 1999; 29: 555-9.
42. Juutilainen J. Developmental effects of electromagnetic fields. *Bioelectromagnetic* 2005; 7: 107-15.
43. Heynick LN, Merritt JH. Radiofrequency fields and teratogenesis. *Bioelectromagnetics* 2003; Suppl. 6: S174-86.
44. Ceconi S, Gualtieri G, Di Bartolomeo A, *et al.* Evaluation of the effects of extremely low frequency electromagnetic fields on mammalian follicle development. *Hum Reprod* 2000; 15 (11): 2319-25.
45. Aksen F, Akdag MZ, Ketani A, *et al.* Effect of 50-Hz 1-mT magnetic field on the uterus and ovaries of rats (electron microscopy evaluation). *Med Sci Monit* 2006J; 12(6): BR215-20.
46. Saunders RD, McCaig CD. Developmental effects of physiologically weak electric fields and heat: an overview. *Bioelectromagnetics* 2005; Suppl 7: S127-S32.
47. Adey WR. Joint actions of environmental non ionizing electromagnetic fields on chemical pollution in cancer promotion. *Environ Health Perspect* 1990; 86: 297-5.

Index of Contributors

- Accurso D., 219
Aleksandrova I.Y., 235
- B**arnes F., 25
Belyaev I.Y., 187
Belpoggi F., 219
Bobkova N.V., 235
Bosco L., 247
Brun A., 333
- Canseven A.G., 157, 319, 379
Chiozzotto D., 219
- D**'Emilia E., 115, 135
Dąbrowski M.P., 149
Davis D.L., 301
De Carlo F., 135
Del Giudice E., 7
DeSalles A., 301
- Eberhardt J., 333
- Fesenko E.E., 235
Figà-Talamanca I., 387
Firlarer A., 157, 379
Fragopoulou A.F., 271
- Georgiou C.D., 63
Ghandi O.P., 301
Giliberti C., 387
Giuliani L., IX, 7, 115, 123, 135, 219
Grimaldi S., 115, 135
Güler G., 157, 319
- H**an Y.-Y., 301
Hardell L., 363
Havas M., 273
Herberman R.B., 301
- Ieradi L.A., 123
- K**elley E., 273
- Lauriola M., 219
Ledda M., 115, 135
- Liboff A.R., 51
Lisi A., 115, 135
- M**almgren L., 333
Manservigi F., 219
Margaritis L.H., 271
Marrongelle J., 273
Medvinskaya N.I., 235
- Nardone P., 387
Nesterova I.V., 235
Nittby H., 333
Novikov V.V., 235
- Ö**zden S., 379
Ozgur E., 319
- P**ersson B.R.R., 333
Pollner B., 273
- R**ees C.R.G., 273
- Salford L.G., 333
Severini M., 247
Seyhan N., 157, 319, 379
Sirav B., 319
Sobiczewska E., 149
Soffritti M., VII, 219
Stankiewicz W., 149
Szmigielski S., 149, 357
- Tepe Çam S., 379
Tibaldi E., 219
Tigrek S., 25
Tomruk A., 157
Tully L., 273
Tuysuz M.Z., 319
- Udroiu I., 123
- Vedruccio C., 177
- Zhadin M., 1

Published: October 2010
by Mattioli 1885 - Fidenza (PR) - Italy

